

YAMAHA®

**AUTHORIZED
PRODUCT MANUAL**

TX81Z

FM TONE GENERATOR

YAMAHA

TX81Z

FM TONE GENERATOR

OWNER'S MANUAL

INTRODUCTION

Thank you for purchasing the Yamaha TX81Z FM Tone Generator. The TX81Z is an 8-note polyphonic FM tone generator that can act as up to 8 independent instruments. It can be used in many ways, both simple and complex. First, you will probably want to try out the preset voices. The simple instructions on the next page tell you how. Then, to get an idea of the full range of possibilities, read "How Does the TX81Z Work?". Detailed explanations of each mode follow. The chapter entitled "Ideas and Suggestions" has some interesting ways to use the TX81Z. Various supplementary reference materials are also included.

CONTENTS

INTRODUCTION	1	OTHER FUNCTIONS	46
CONTENTS	1	IDEAS AND SUGGESTIONS	47
FEATURES	2	DX21/DX27/DX100 COMPATIBILITY	48
SIMPLE PLAYING INSTRUCTIONS	3	MICRO TUNING DATA TABLE	49
CONNECTIONS	3	WAVEFORM HARMONIC CONTENT	50
ADJUST VOLUME	3	PERFORMANCE DATA	51
SELECT VOICES	4	PERFORMANCE MEMO CHART	63
TX81Z PRESET VOICENAMES	4	VOICE DATA LIST	64
HOW DOES THE TX81Z WORK?	5	MIDI RECEPTION/TRANSMISSION	65
FRONT/REAR PANEL	7	SYSTEM EXCLUSIVE DATA FORMAT	67
PLAY SINGLE	11	PARAMETER CHANGE MESSAGES	67
STORE VOICE	11	BULK DATA MESSAGES	68
SINGLE EDIT	12	DUMP REQUEST MESSAGES	70
EDITING PROCEDURE	12	SPECIFICATIONS	78
COMPARE	13	MIDI IMPLEMENTATION CHART	79
SINGLE UTILITY	24	WHAT'S MIDI?	80
PLAY PERFORMANCE	35	MIDI MESSAGES	82
STORE PERFORMANCE	36	WHAT'S FM?	83
PERFORMANCE EDIT	37	INDEX	86
EDIT PROCEDURE	37		
THE PERFORMANCE EDIT BUFFER	37		
PERFORMANCE UTILITY	42		

FEATURES

- *Produces up to 8 different voices simultaneously, making it ideal for use with a MIDI sequence recorder.
- *Voices and all memory parameters can be edited from the front panel. No separate programming device or computer is necessary.
- *New LSI tone generator chip can perform FM synthesis using a total of 8 different waveforms.
- *“Pseudo-reverb” effect programmable for each voice.
- *Either Fixed or Ratio frequencies are selectable for each operator.
- *Two independent LFOs and a Vibrato Generator.
- *While voice and function data is compatible with DX21/27/27S/100 voice data, the sound quality has been upgraded, and the resolution of the EGs has been improved.
- *128 ROM factory preset voices.
- *32 user-programmable voice memories.
- *24 user-programmable performance memories.
- *13 Microtonal Scales (2 user-programmable and 11 preset).
- *Pan, Single Note Chord, and Transposed Delay effects.
- *Save and load TX81Z memory data to and from a cassette.
- *Transmit and receive TX81Z memory data via MIDI.
- *Program Change Table for re-directing program change messages.
- *Alternate Voice Assign lets you play a different voice with each successive note.

SIMPLE PLAYING INSTRUCTIONS

CONNECTIONS

Connect the MIDI OUT of your keyboard to the TX MIDI IN, and connect the audio output of the TX to an amp/speaker system as shown. Set the transmission channel of your keyboard to channel 1 (see the owner's manual for your keyboard).

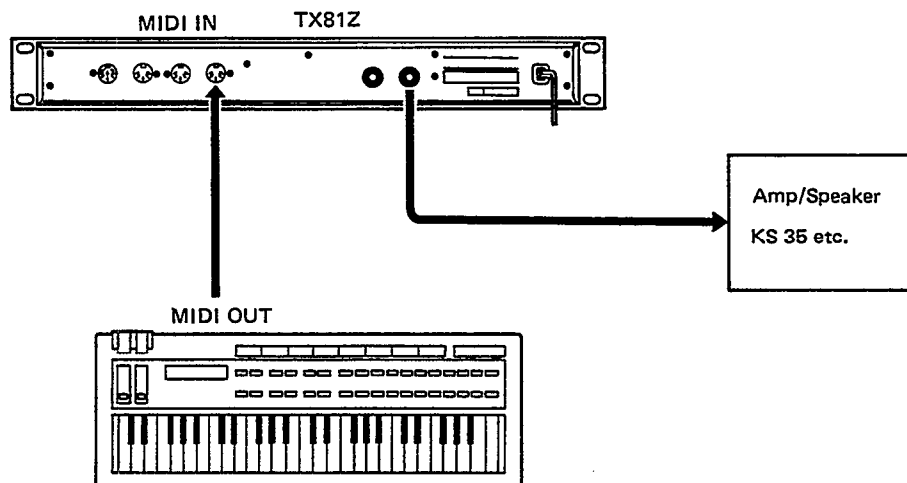

When you turn the TX81Z power on, it will flash each LED, display “*YAMAHA TX81Z* <Good morning!!>” for a few seconds (this greeting can be changed, see p.46), and then display whatever function was selected when the power was turned off. Press SINGLE/PERFORMANCE to make the display read “PLAY SINGLE”. (You may have to press it twice,)

Press once or twice



ADJUST VOLUME

Playing the keyboard should produce sound. Adjust the TX81Z output volume by pressing the MASTER VOLUME keys. The LCD will show a bar graph indicating the volume. (To adjust volume, the CURSOR LED must be off.)

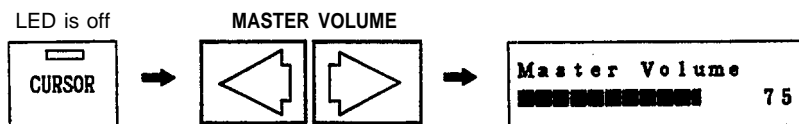

If no sound

*Perhaps the TX81Z MIDI Receive Channel does not match the Transmit Channel of your keyboard. Press UTILITY to get the “UTILITY MODE” display. Use the PARAMETER keys to get the “Midi Control?” display and press “YES” to get “Basic Rcv.Ch=xx”. Use the DATA ENTRY keys to set the channel to match the MIDI output channel of your keyboard (or set it to “omni” so it will receive all channels).

*It is possible that the voice is set so that its volume is regulated by a controller such as Foot Controller or Breath Controller. If your keyboard has a volume control slider or a Foot Controller, try moving them up to max position.

SELECT VOICES

The TX81Z has 5 banks of 32 voices. Banks A-D contain factory preset voices. (When the unit is shipped, bank "I" contains selected voices from bank A-D.) Use the PARAMETER keys to select banks I, A, B, C, D. Use the DATA ENTRY keys to select voices 1-32 in each bank.

TX81Z PRESET VOICENAMES

BANK A		BANK B		BANK C		BANK D	
1	GrandPiano	1	Trumpet81Z	1	NylonGuit	1	BaadBreath
2	Uprt Piano	2	Full Brass	2	Guitar # 1	2	VocalNuts
3	Deep Grd	3	FlugelHorn	3	TwelveStrg	3	KrstlChoir
4	HonkeyTonk	4	ChorusBras	4	Funky Pick	4	Metalimba
5	Elec Grand	5	French Horn	5	AllThatJaz	5	WaterGlass
6	Fuzz Piano	6	AtackBrass	6	HeavyMetal	6	BowedBell
7	SkoolPiano	7	SpitBoneBC	7	Old Banjo	7	> >WOW< <
8	Thump Pno	8	Horns BC	8	Zither	8	Fuzzy Koto
9	LoTine81Z	9	MelloTenor	9	ElecBass 1	9	Spc Midiot
10	HiTine81Z	10	RaspAlto	10	SqncrBass	10	Gurgle
11	ElectroPno	11	Flute	11	SynFunkBas	11	Hole in 1
12	NewElectro	12	Pan Floot	12	ElecBass 2	12	Birds
13	DynomiteEP	13	Basson	13	AnalogBass	13	MalibuNite
14	DynoWurlie	14	Oboe	14	Jaco Bass	14	Helicopter
15	Wood Piano	15	Clarinet	15	LatelyBass	15	Flight Sim
16	Reed Piano	16	Harmonica	16	Monoph Bass	16	Brthbells
17	PercOrgan	17	DoubleBass	17	StadiumSol	17	Storm Wind
18	1 6 8 4 2 F	18	BowCello	18	TrumprtSolo	18	Alarm Call
19	PumpOrgan	19	BoxCello	19	BCSexyPhon	19	Racing Car
20	<6 Tease>	20	SoloViolin	20	Lyrisyn	20	Whistling
21	Farcheeza	21	HiString 1	21	WarmSquare	21	Space Talk
22	Small Pipe	22	LowString	22	Sync Lead	22	Space Vibe
23	Big Church	23	Pizzicato	23	MellowSqar	23	Timpani
24	AnalogOrgn	24	Harp	24	Jazz Flute	24	FM Hi-Hats
25	Thin Clav	25	ReverbStrg	25	Heavy Lead	25	Bass Drum
26	EZ Clav	26	SynString	26	Java Jive	26	Tube Bells
27	Fuzz Clavi	27	Voices	27	Xylophone	27	Noise Shot
28	LiteHarpsi	28	HarmoPad	28	GreatVibes	28	Snare 1
29	Rich Harpsi	29	FanfarTpts	29	Sitar	29	Snare 2
30	Celeste	30	HiString 2	30	Bell Pad	30	Hand Drum
31	BriteCelst	31	PercFlute	31	PlasticHit	31	Synballs
32	Squeezebox	32	BreathOrgn	32	DigiAnnie	32	Efem Toms

HOW DOES THE TX81Z WORK?

The TX81Z has two main modes. Each main mode has three “sub-modes”.

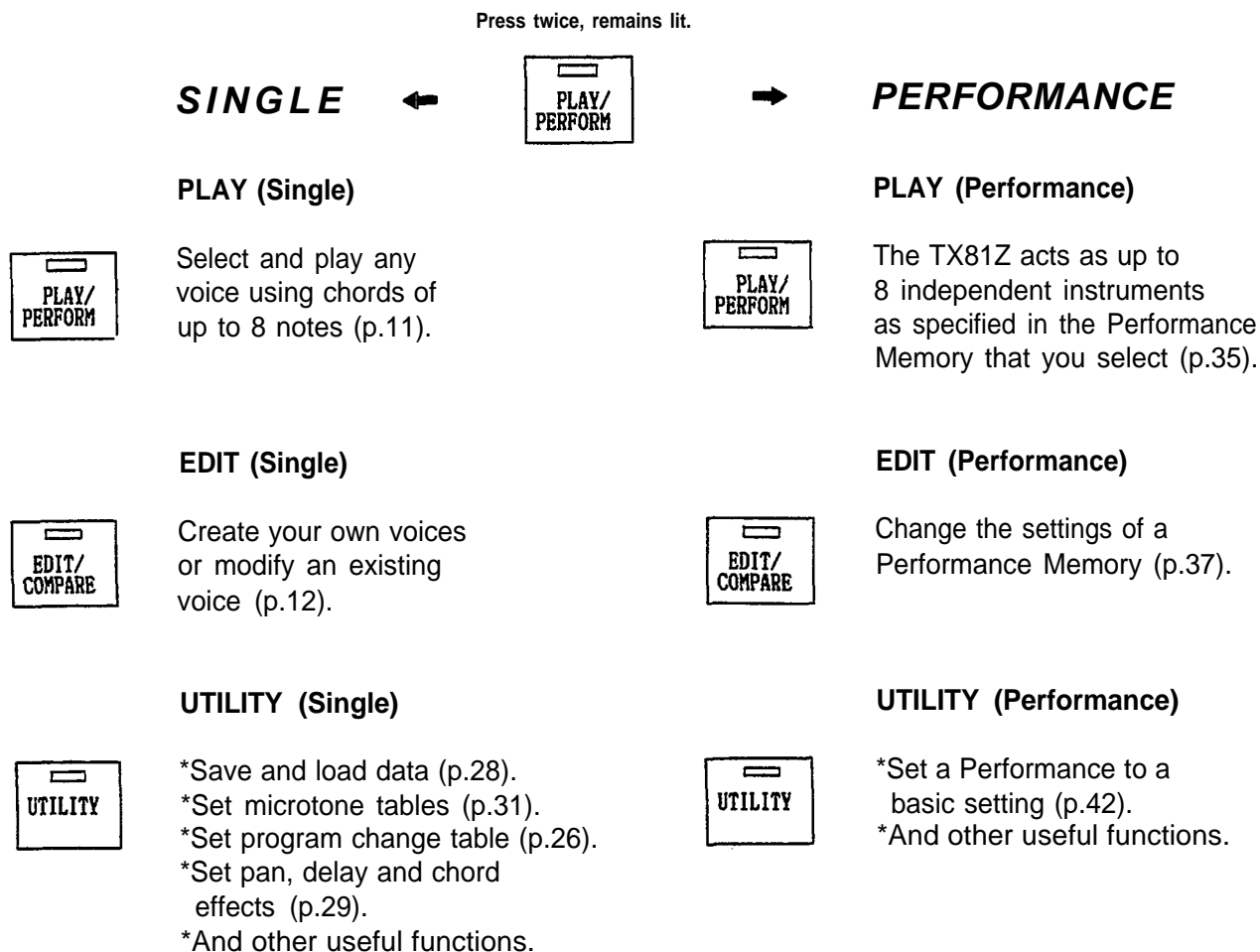

Here are the main memory areas inside the TX81Z.

Voice Memory (p.11)

There are 5 voice memory banks, each with 32 voices. Banks A-D are preset, and cannot be changed. Bank I is for you to store your own voices in.

Performance Memory (p.35)

Each performance memory can set the TX81Z to act as up to 8 independent instruments, each controlled on a different channel.

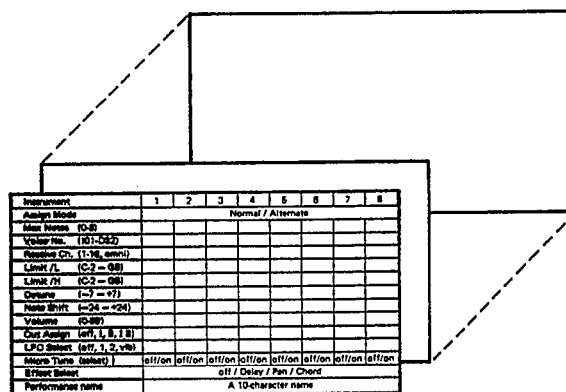

Instrument	1	2	3	4	5	6	7	8
Assign Mode	Normal / Alternate							
Max Notes (0-8)								
Volume No. (01-512)								
Receive Ch. (1-36, smc)								
Limit L (C2 - 08)								
Limit H (C2 - 08)								
Circle (1 - 11)								
Note Shift (1 - 24)								
Volume (0-99)								
Cut Assign (left, L, B, I, S)								
LFO Select (off, 1, 2, vrb)								
Wave Tune (select)	off/on	off/on	off/on	off/on	off/on	off/on	off/on	off/on
Effect Select	off / Delay / Pan / Chord							
Performance name	A 10-character name							

Effect Memory (p.29)

Each performance can use one of the three effects.

Effect 1 (Delay)	
Delay Time	
Pitch Shift	
Feedback	
Effect Level	

Effect 2 (Pan)	
Direction	
Pan Speed	

Effect 3 (Chord)												
Key on note	C	C#	D	D#	E	F	F#	G	G#	A	A#	B
Chord note												

Program Change Table (p.26)

Incoming program change messages can select anything you want; voices or performance memories.

Incoming	Selected
1	B19
2	PF24
3	I07
127	A32
128	C14

Microtune Tables (p.31)

You can use non-standard scales. 11 scales are preset. The Octave and Full Settings are user programmable.

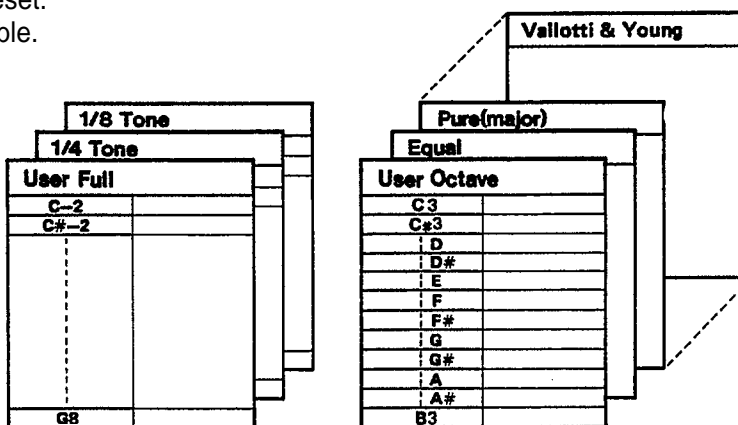

1/8 Tone	
1/8 Tone	

1/4 Tone	
1/4 Tone	

User Full	
C-2	
C#-2	
GB	

User Octave	
C3	
C#3	
D	
D#	
E	
F	
F#	
G	
G#	
A	
A#	
B3	

FRONT/REAR PANEL

FRONT PANEL

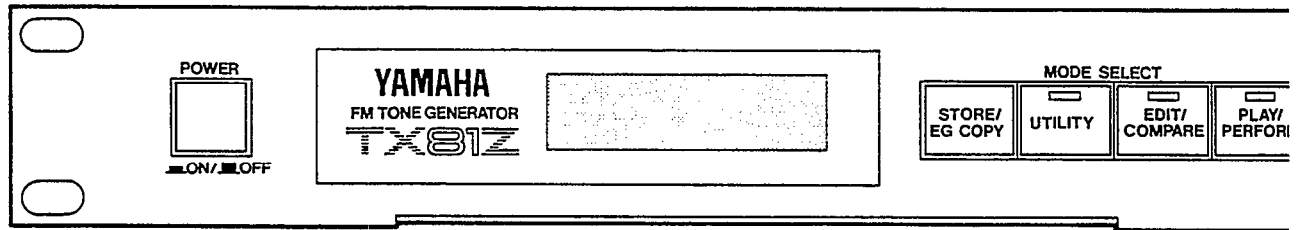

LCD

A two-row 16-character Liquid Crystal Display, back-lit for high visibility.

OPERATION GUIDE

A pull-out card lists the main operations of the TX81Z.

STORE/EG COPY

In PLAY/PERFORM mode, this is used to store voices or performances.

In SINGLE EDIT mode, it copies an Envelope setting from one operator to another.

UTILITY

This enters UTILITY mode, where you can save and load data, set up effects and microtonal scales, and perform various other useful functions.

EDIT/COMPARE

In SINGLE mode, this enters SINGLE EDIT mode, and selects the edited voice or the original voice. The blinking EDIT/COMPARE LED indicates that the original voice is selected. In PERFORMANCE mode, this enters PERFORMANCE EDIT mode.

PLAY/PERFORM

When already in PLAY mode, this selects SINGLE or PERFORMANCE mode. If you have been in UTILITY or EDIT, this will return you to PLAY mode. The LED blinks to indicate an incoming note.

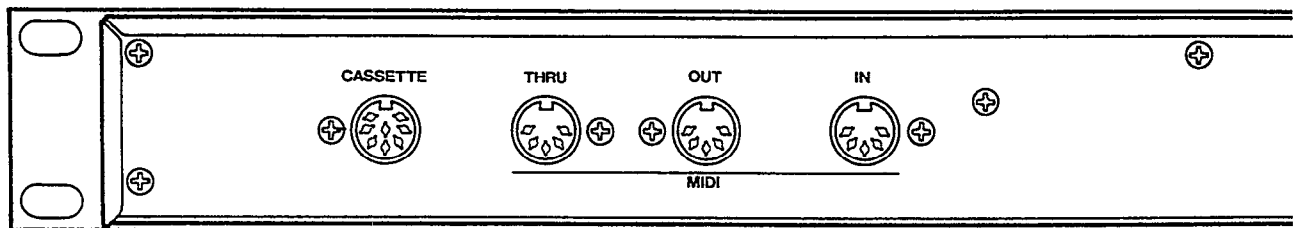

REAR PANEL

CASSETTE

Use the included cassette cable to connect this to a data cassette recorder for saving and loading TX81Z data.

MIDI THRU

All messages received at MIDI IN are re-transmitted unchanged from this terminal.

MIDI OUT

TX81Z bulk data can be sent from this terminal.

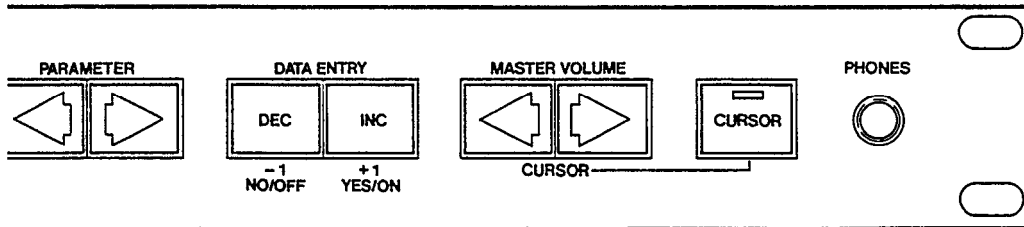

PARAMETER

In PLAY SINGLE mode, these select voice memory banks I, A, B, C, D. In EDIT and UTILITY modes, they step through the parameters or jobs.

DATA ENTRY

In PLAY SINGLE mode, these select voices 1-32. In PLAY PERFORMANCE mode, these select performances 1-24. In EDIT and UTILITY modes, they are used to change settings or answer "No/Yes".

MASTER VOLUME/CURSOR

When the CURSOR LED is off, these keys control the master volume of the entire unit. When the CURSOR LED is on, these keys move the blinking cursor.

CURSOR

This selects the function of the MASTER VOLUME/CURSOR keys.

PHONES

A jack for standard stereo headphones. (The volume is controlled by MASTER VOLUME. See above.) Using this jack will not affect the rear panel outputs. If output II is not plugged in, the phones will have a mono signal of both outputs mixed.

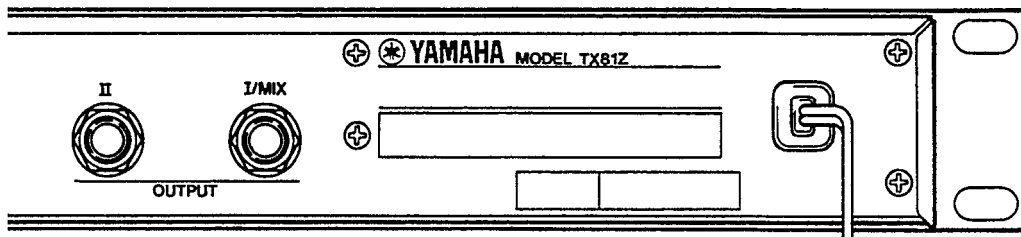

MIDI IN

MIDI messages coming into this terminal will make the TX81Z produce sound, and TX81Z bulk data can also be received here.

OUTPUT I, II

Sound produced by the TX81Z is sent from here to an external mixer or amp. If only output I is used, it will transmit the combined signal from both outputs.

SINGLE MODE

In this mode, the TX81Z will act as a single, 8-note polyphonic instrument. Single mode also allows you to create or edit voices.

PLAY SINGLE

Use the PARAMETER keys to select voice banks I, A, B, C, D, and use the DATA ENTRY keys to select voices 1-32.

PLAY SINGLE
A01 GrandPiano

Bank I, A-D Voice number and name

The 128 factory preset voices are listed on p.4. If the Program Change Conversion table (p.26) is initialized, incoming MIDI Program Changes 1-32 will select bank I 1-32 (internal user memories), 33-64 will select from bank A, and so on.

When the TX81Z is shipped, the internal user memories I01-132 contain selected voices from banks A-D.

STORE VOICE

You can store the currently selected voice (edited or not) in the Internal user memory (Bank I). While in PLAY SINGLE mode, press and hold the STORE key. The LCD will ask



so continue holding STORE and use the DATA ENTRY keys to select the store destination (I01-I32).



Select destination

When the LCD shows the destination you want, release STORE and press YES. The voice will be stored into the selected memory. (You can quit without storing by pressing NO.)

SINGLE EDIT

This is where you create your own voices, or edit the preset voices. In this section we assume you already know something about FM synthesis. If you are new to FM, please turn to p.83 and read "What's FM?" before continuing.

EDITING PROCEDURE

In SINGLE mode, press EDIT/COMPARE. The EDIT LED will light, and the LCD will show the previously edited parameter. Use the PARAMETER keys to move through the parameters, Use the DATA ENTRY keys to change the data value. When the LCD shows several parameters at once, use the CURSOR keys to move the blinking cursor to the parameter you want to set. (The CURSOR LED will automatically come on when you enter EDIT mode.) Some parameters are in groups, and when the LCD shows "xxxxxx ?" you can press YES to edit the parameters inside the group.

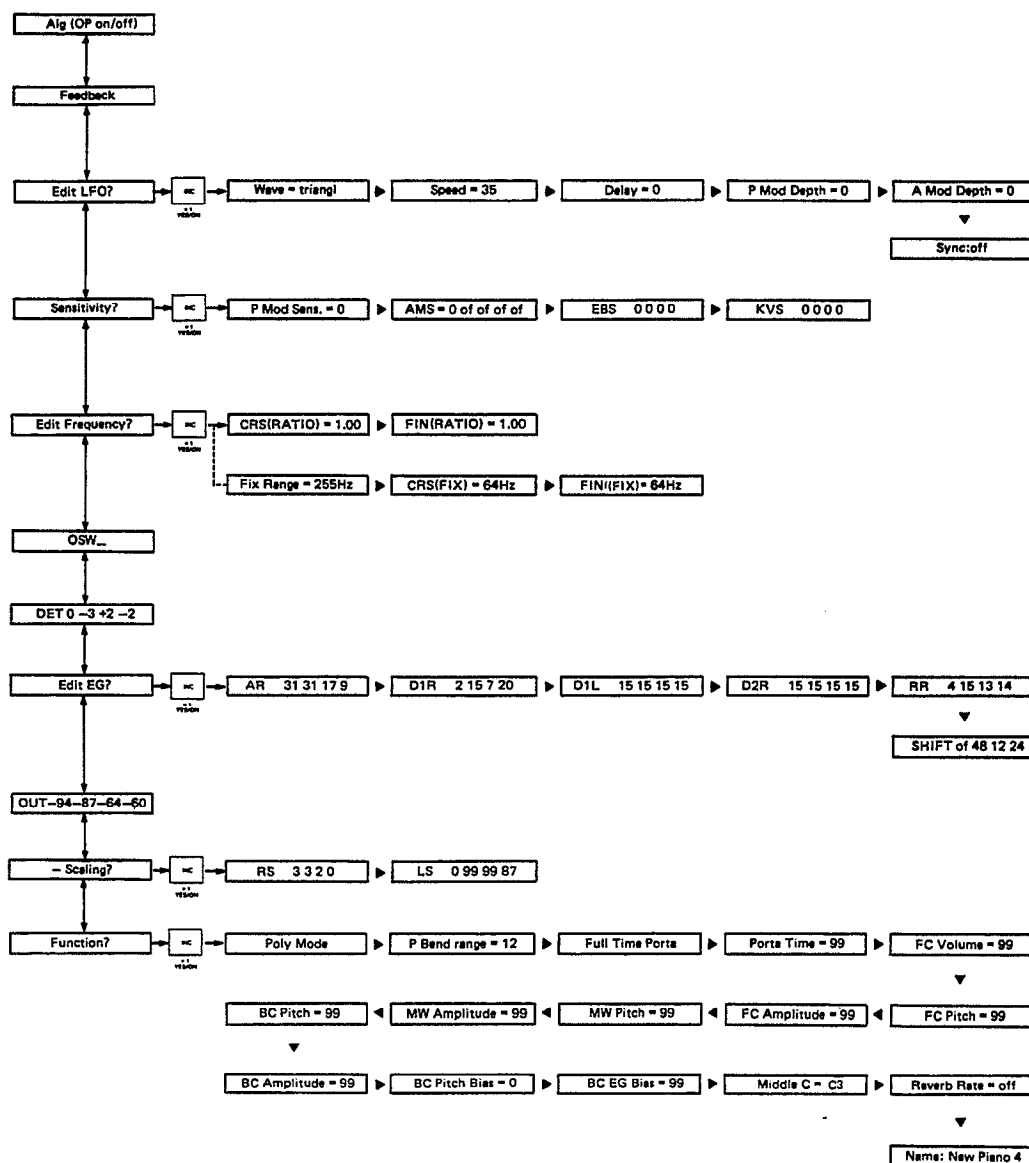

COMPARE

When you first enter SINGLE EDIT mode, the LCD will show an "E" in the upper left corner, indicating "Edit". As soon as you modify the data, this will change to "e".

Original data unchanged

```

E1111  ALG8
Feedback (OP4) - 3
    
```

Modifications have been made

```

e111  ALG8
Feedback (OP4) - 4
    
```

While editing a voice, you can compare it with the original voice. Press EDIT/COMPARE. The LED will begin blinking, and the LCD will show a "c" in the upper left corner, indicating "Compare". Use the PARAMETER keys to look through the parameters. When the Compare LED is flashing, you will not be able to modify the data. To return to edit mode, press EDIT/COMPARE once more.

Compare original voice

```

c1111  ALG8
Feedback (OP4) - 3
    
```

Algorithm

This is where you select the Algorithm, or "arrangement" of operators.

Operator 1-4 on/off

```

e1101      4→3→
ALG=5      2→1→
    
```

1-8

In addition to the algorithm number, the LCD shows a graphic representation of the actual algorithm structure. The arrows indicate the modulator → carrier connection. (See also the pull-out reference card under the LCD.)

By moving the cursor to the "1111" area and pressing DEC/INC, you can turn each operator on (1) or off (0). When editing, it is often useful to hear only a certain combination of operators at once. Obviously, if all carriers are turned off, there will be no sound.

Feedback

In any algorithm, operator 4 can be set to modulate itself on a scale of 0 (no feedback) to 7.

```

e1111  ALG5
Feedback (OP4) - 3
    
```

0-7

Edit LFO?

The LFO is a Low Frequency Oscillator that sends a continuously changing control signal. Its effect depends on the Sensitivity (p.16) and Voice Function (p.21) settings, and can affect the output level of the operators or the overall pitch of the voice. As you can see from the diagram below, the Voice Function settings determine how the MIDI Controllers (Modulation Wheel, Foot Controller, Breath Controller) will regulate the LFO signal going to the operators, and the Sensitivity settings determine how the operators will react to the LFO signal.



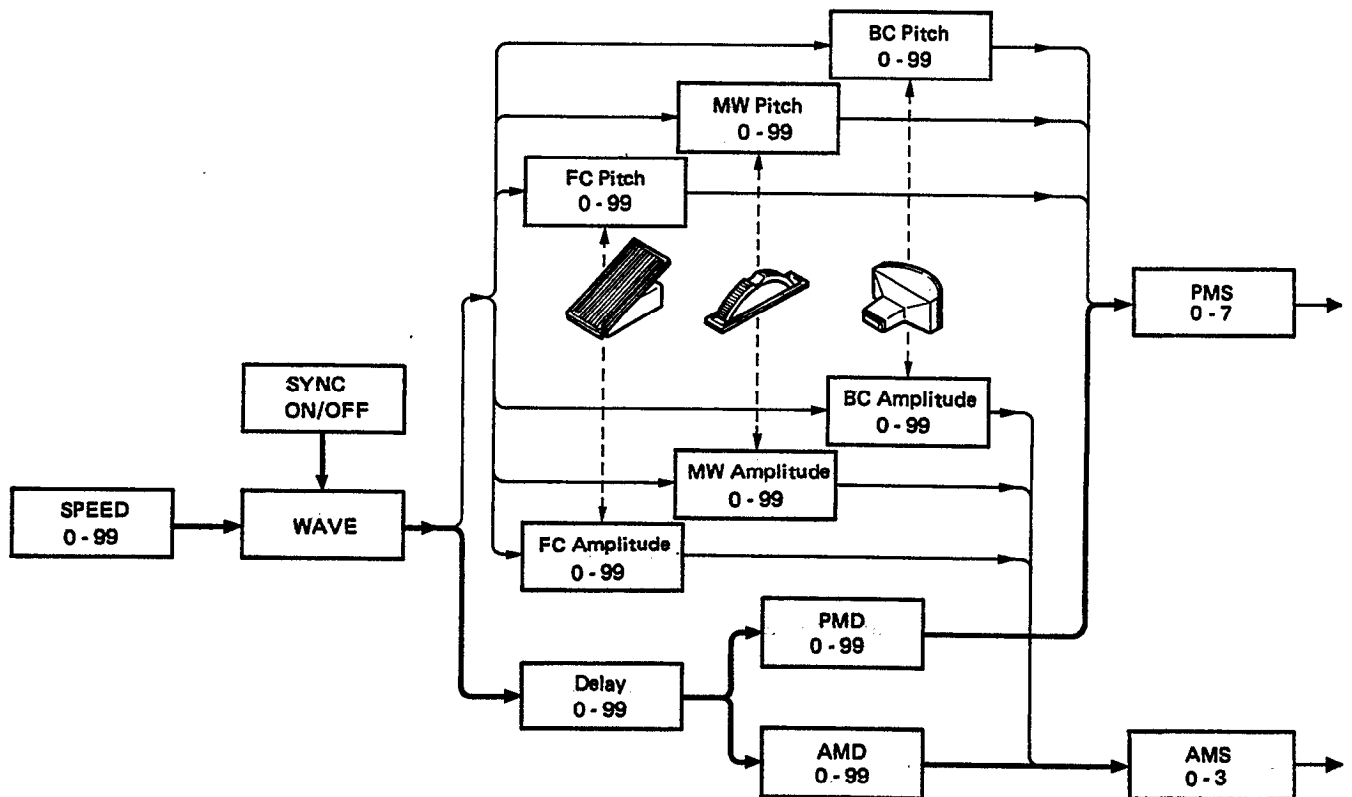

As you can see, the modulation you set in the LFO does NOT go DIRECTLY to the operators. The final effect will depend on the LFO Settings, the Voice Function settings, the Sensitivity settings, AND the position of the MIDI controllers (Modulation Wheel, Foot Controller, Breath Controller) on your keyboard.

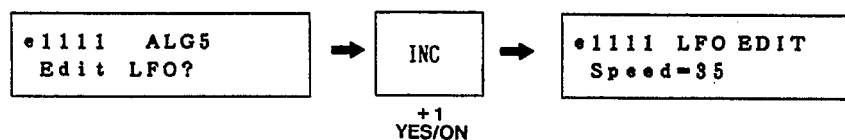

This “modulation matrix” may seem complex, but it gives you total expressive control over your instrument. Answer YES to this display and use the PARAMETER keys to select the six LFO parameters.

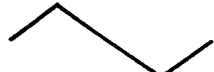

Wave (saw up, square, triangle, S/Hold)

saw up (saw tooth wave)	
square (square wave)	
triangle (triangle wave)	
S/Hold (sample & hold)	

The first three waveshapes are probably familiar to you. S/Hold stands for Sample And Hold. At periodic intervals determined by the LFO Speed, a random number is sampled, and the LFO is held at that random value until the next sample. This is especially useful in creating sound effects.

Speed (0-99)

At a setting of 1, the LFO will take about 150 seconds to complete one cycle (0.007Hz), and at a setting of 99 the LFO will make about 50 cycles every second (50Hz).

Delay (0-99)

In many acoustic instruments, the vibrato begins a short time after the note begins sounding. This can be simulated using the LFO Delay, which is adjustable from 0 (no delay) to 99 (about 15 seconds delay).

Pitch Modulation Depth (0-99)

This controls the amount of Pitch Modulation that will be present regardless of the Function Settings. When this value is above 0, the LFO will always produce some Pitch Modulation, regardless of the position of the Foot Controller, Mod Wheel or Breath Controller, provided that P. Mod Sens is not zero.

Amplitude Modulation Depth (0-99)

This controls the amount of Amplitude Modulation that will be present regardless of the Function settings. When this value is above 0, the LFO will always send some Amplitude Modulation to the operators, regardless of the position of the Foot Controller, Modulation Wheel or Breath Controller, provided that at least one operators has an AMS value greater than zero.

Sync (on/off)

When Sync is on, each note will reset the LFO wave to its beginning. For example, the Saw Up wave would begin again from the lowest position at the beginning of the note. When sync is off, the LFO wave will keep repeating regularly, regardless of notes being played.

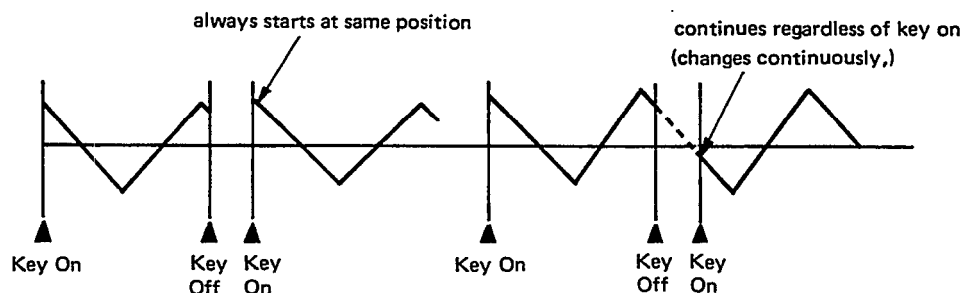

Sensitivity?

This is where you set the sensitivity of the voice to LFO Pitch Modulation, and set the sensitivity of each operator to incoming LFO and other control signals. Answer YES and use the PARAMETER keys to select the four Sensitivity parameters.

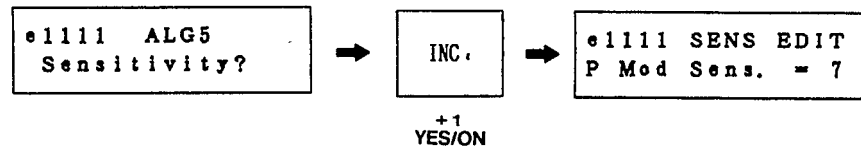
**P Mod Sens. (0-7)**

This determines the Pitch Modulation Sensitivity of the entire voice. If it is 0, there will be no pitch modulation.

AMS (0-3, on/off for each operator)

The overall Amplitude Modulation Sensitivity of the operators is adjustable from 0-3, and each operator can be set to react to LFO Amplitude Modulation (on) or not (off). For example, if the carrier operators were sensitive to LFO amplitude modulation, the LFO would affect the volume of the voice (tremolo). If the modulator operators were sensitive to LFO amplitude modulation, the LFO would affect the tone of the voice (wah-wah).

EBS (0-7 for each operator)

This sets the EG (envelope generator) Bias Sensitivity of each operator. EG Bias is a control signal that directly affects the output level of an operator. (It has nothing to do with the LFO.) There is a Voice Function parameter (p.22) that lets a Breath Controller control EG Bias.

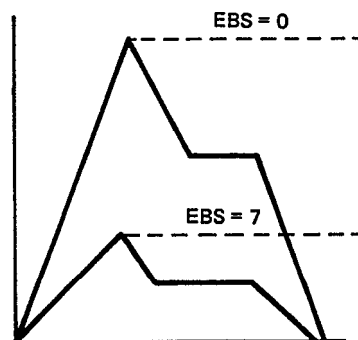

If a carrier has EBS, the EG Bias signal will affect the volume of the voice. If a modulator has EBS, the EG Bias signal will affect the tone of the voice. When programming wind instruments, it is effective to set the carriers to an EBS of 7, so that the volume will depend totally on how hard you blow into the Breath Controller. Set the modulators to a lower value of sensitivity, so that the tone will become somewhat sharper as you blow harder.

KVS (0-7 for each operator)

This sets the Key Velocity Sensitivity of each operator. Each MIDI Note On message has a Velocity byte that tells how hard the keyboard was struck. If an operator has KVS, it will adjust its output level according to the velocity of the note. If a carrier has KVS, strongly played notes will be louder. If a modulator has KVS, strongly played notes will have a sharper tone. Extremely high KVS settings will make the voice difficult to control, and you will need to play quite strongly to get any sound at all.

Edit Frequency?

This is where you set the frequency of each operator. Each operator can be set to Ratio or Fixed mode. In Ratio mode, the frequency will depend on the key you play. In Fixed mode, the frequency will be the same no matter which key you play. This can be useful for special effects, or for creating “formants” (fixed characteristics of spectral emphasis found in human voices and some instruments).

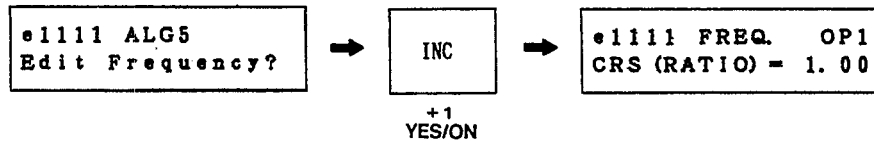

Answer YES to this display, and use the PARAMETER keys to select the coarse (CRS) and fine (FIN) frequency adjustment for each operator 1-4. By moving the cursor to (xxx), you can set the oscillator mode to RATIO or FIX.

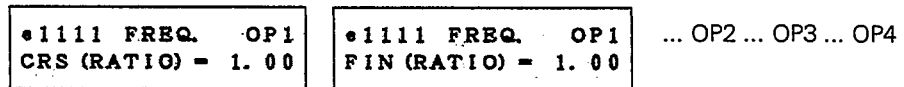

If Fixed Mode is selected, you can set the Fixed Frequency Range (see below).

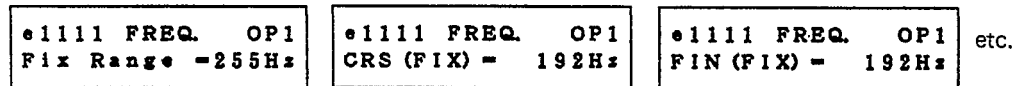

Ratio (0.50-27.57)

The “standard” ratio is 1.00. I.e. when a operator is set to 1.00 frequency ratio, it will produce a 440Hz tone for an A3 note (standard pitch). A ratio of 2.00 would be an octave higher, and 4.00 would be two octaves higher.

Fix Frequency (8Hz-32,640Hz)

The fixed frequency is variable over a wide range. (However, due to hardware limitations, the very highest frequencies will not actually be output.) Fixed Frequency is divided into the ranges shown below.

Select (Hz)	Fix Range (Hz)	One Fine Step (Hz)
255	8-255	1
510	16-510	2
1K	32-1020	4
2K	64-2040	8
4K	128-4080	16
8K	256-8160	32
16K	512-16320	64
32K	1024-32640	128

Oscillator Wave

The TX81Z is the first Yamaha synthesizer to offer FM synthesis with 7 new waveforms in addition to sine waves.

Each operator can be independently set to one of the following 8 waveforms. The selected waveform will be graphically indicated in the LCD.

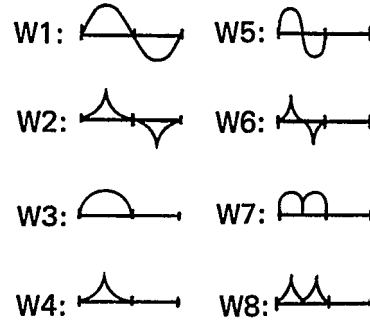
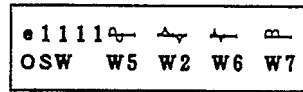

These new waveforms can be used as both carriers and modulators. Sine waves are pure tones. The seven additional waveforms have additional harmonics already in them. This allows for complex waveforms to be created from fewer operators. For ideas on how to use the new waveforms, examine the preset voices. The harmonic content of each waveform is described on p.50.

Detune

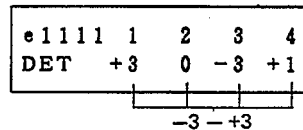

The frequency of each operator can be moved slightly higher or lower. By detuning two carriers in opposite directions, you can create a detune-chorus effect. By detuning a modulator and carrier, you can create slightly irregular, "natural-sounding" harmonic structures. The exact amount of detune will differ by the note number. At C3 the range is ± 2.6 cents.

Edit EG?

Answer YES to this display and use the PARAMETER keys to select the six EG parameters. Each display shows the settings for operators 1-4.

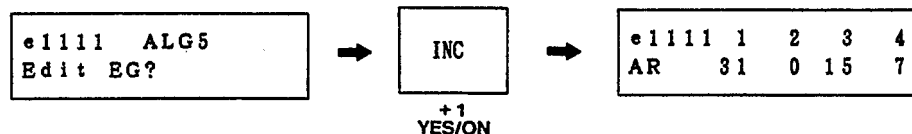

The Envelope Generator (EG) determines how the operator output level changes over time. TX81Z EGs have 4 rate (speed) parameters and 1 level parameter. In addition, you can "shift" the range of the entire envelope by a specified amount, so that there will be some operator output even when a note is not being pressed.

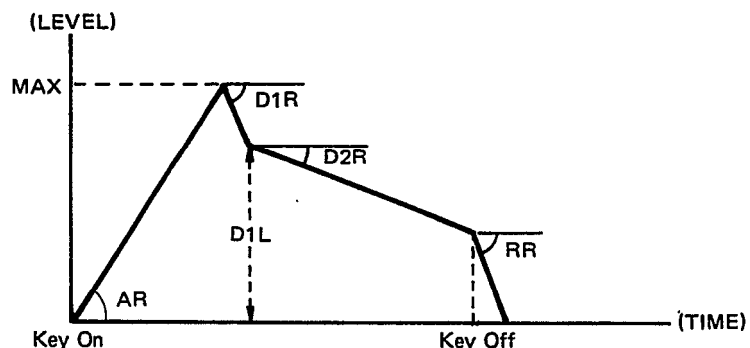

SINGLE: Edit

AR (0-31)

Attack Rate determines how quickly the level will rise up to maximum level. When AR is 0, the rate is slowest and when AR is 31, the attack is fastest,

D1R (0-31)

1st Decay Rate determines how quickly the level will decay from maximum to the 1st Decay Level. Obviously, if the 1st Decay Level is 15 (max), the 1st Decay Rate will have no effect.

D1L (0-15)

1st Decay Level is the point where the 2nd Decay Rate begins.

D2R (0-31)

2nd Decay Rate determines how quickly the level will decay from the 1st Decay Level down to 0. If the 2nd Decay Rate is set to 0, the sound will continue as long as the note is held.

RR (1-15)

Release Rate determines how quickly the level will decay from the level at the time the note is released down to 0.

SHFT (off, 48, 24, 12)

EG Shift sets the range of the envelope. When "off" is selected, the EG will change the operator output level over a range of 0 to -96dB (the full range). However, when 12, 24 or 48 is selected, the EG range is "compressed" to the specified range. For example if EG Shift is 24, the EG will change the operator output level over a range of 0 to -24dB, and the operator output level will be at -24dB even before the note is pressed. (EG shift of operator 1 is fixed at "off".)

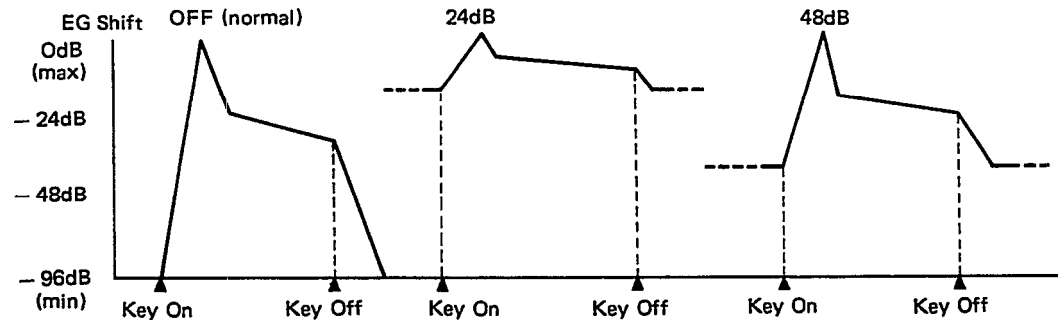

This can be used to limit the EG range of a modulator for very subtle changes in tone, or to create an instantaneous attack. You can use it on a carrier for effects that will sound even when a key is not being pressed. The EGS setting will not affect the time the envelope takes, even though the "distance" of the level change may be different (ie. "rates" are automatically compensated).

EG Copy

When trying to imitate an acoustic instrument sound, it is usually a good idea to first program the carrier envelope (volume envelope) and copy it to the modulating operators. (Of course you will need to make fine adjustments later by ear.) Usually, as the volume of a sound increases (or decreases), the tone also gets brighter (or softer).

Copying envelopes is easily done. Anytime you are in SINGLE EDIT mode, press and hold STORE/EG COPY. The LCD will ask which operator you want to copy the envelope from.

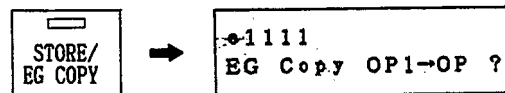

Continue holding STORE/EG COPY and use the DATA ENTRY keys to select the source operator. Use the CURSOR keys to move the blinking cursor and use the DATA ENTRY keys to select the destination operator. Release STORE/EG COPY and answer YES. The envelope (AR, D1R, D1L, D2R, RR) will be copied. (If you change your mind, answer NO.)

Operator Output Level

This sets the output level of each operator.

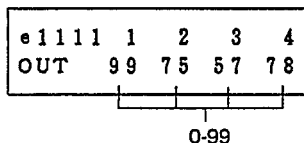

The output level of a carrier will affect the volume, and the output level of a modulator will affect the tone. Setting modulator output levels too high may lead to distortion. Sometimes this may be desirable when creating sound. What the human ear interprets as loudness is closely related to timbral complexity (tone), and raising the level of a modulator will often increase the "loudness" as well.

Scaling?

Answer YES to this display and use the PARAMETER keys to select the two scaling parameters.

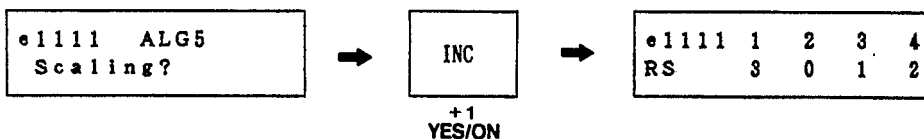

Rate Scaling (0-3)

On an acoustic instrument, high notes usually have a faster attack and decay than low notes. Rate Scaling simulates this. When RS is 0, the envelope will be the same time length for all notes. When RS is 3, high notes will have a shorter envelope.

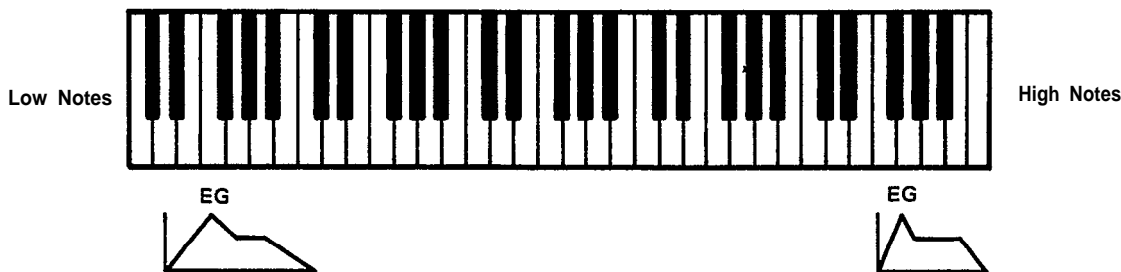

Level Scaling (0-99)

High notes on an acoustic instrument tend to have a less complex tone than low notes. You can use Level Scaling to simulate this by decreasing the output level of a modulator as you play up the keyboard. (Level Scaling operates on a curve starting from about C1.) When LS is 0, the operator output level will be the same for all notes. When LS is 99, the output level will have dropped to 0 by the time you get to G6.



Function?

This is where you set how the TX81Z will be controlled by incoming MIDI messages. Answer YES to the “?” display and use the PARAMETER keys to select the sixteen Function parameters.

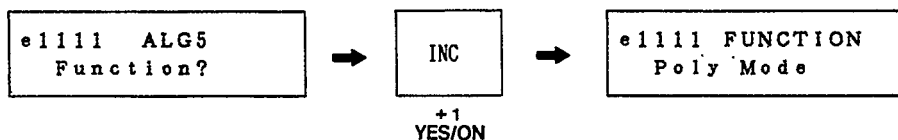

Poly Mode (Poly/Mono)

Poly Mode: In SINGLE mode, the TX81Z will play up to 8 notes simultaneously, and in PERFORMANCE mode, each instrument will play as many notes as permitted in the “Max Notes” setting for that instrument (p.38).

Mono Mode: Only the most recent note you press will be sounded. This can be desirable when playing solos. Also, Mono Mode gives you a choice of portamento (see below). A Max Notes (p.38) setting of 1 is not quite the same as Mono mode. In Mono, a note played before the previous one is released will not re-trigger the envelope. ie. the decay will continue from the previous note. However in Poly mode, each note starts its envelope from the beginning even if the previous note has not been released. Thus, if you want to have only one note sounding at a time, but want each note to re-trigger the envelope, use Poly mode and set Max Notes (p.38) to 1.

Note

If you play a note in Mono Mode without releasing the previous note, and then release the second note, the sound will “jump back” to the previous note. In SINGLE mode, up to 8 of these previous notes will be remembered (as long as you continue pressing them), and in PERFORMANCE mode, up to 5 notes will be remembered.

P Bend Range (0-12)

This determines the range (in semitones) of the pitch bend effect. When set to 12, the pitch bend wheel on your keyboard will have a maximum effect of one octave up or down. When set to 0, the pitch bender will have no effect.

*Full Time Portamento/
Fingered Portamento*

There are two modes of Portamento (the “glide” between notes), but you have a choice only in Mono Mode. If Poly Mode is selected, this will always be “Full Time Portamento”. With Fingered Portamento, portamento is applied only if you press a note before releasing the previous one. With Full Time Portamento, portamento is applied between all notes. Full Time Portamento can be turned on or off by a portamento footswitch connected to your keyboard, but Fingered Portamento cannot be switched off. If you don’t want to have Portamento, set the Portamento Time to 0 (see below). When power is turned on, portamento will be on. (And when a Performance is selected, portamento will be on for each instrument in the performance.) To turn portamento off, you will need to send a Portamento Off message (Bn.41.00)

Portamento Time (0-99)

This sets the speed of the “glide” effect between notes. When Portamento Time is at 99, a three-octave glide will take about 30 seconds. When Portamento Time is at 0, there will be no glide. If you don’t want a voice to have portamento, set the Portamento Time to 0.

FC Volume (0-99)

This allows you to use the Foot Controller connected to your keyboard to control the volume of the TX81Z voice. When FC Volume is at 99, the volume of the TX voice is regulated completely by the Foot Controller, ie. when the Foot Controller pedal is at minimum position, there will be no sound. When FC Volume is at some middle value such as 50, there will be some sound even when the Foot Controller pedal is at minimum.

FC Pitch (0-99)
FC Amplitude (0-99)
MW Pitch (0-99)
MW Amplitude (0-99)
BC Pitch (0-99)
BC Amplitude (0-99)

These six parameters allow you to regulate the amount of LFO modulation using an external controller connected (or built in) to your keyboard. The diagram below explains how LFO modulation is controlled. Each parameter can be set between 0 and 99. When it is set to 0, the position of the controller will have no effect on the amount of LFO modulation,

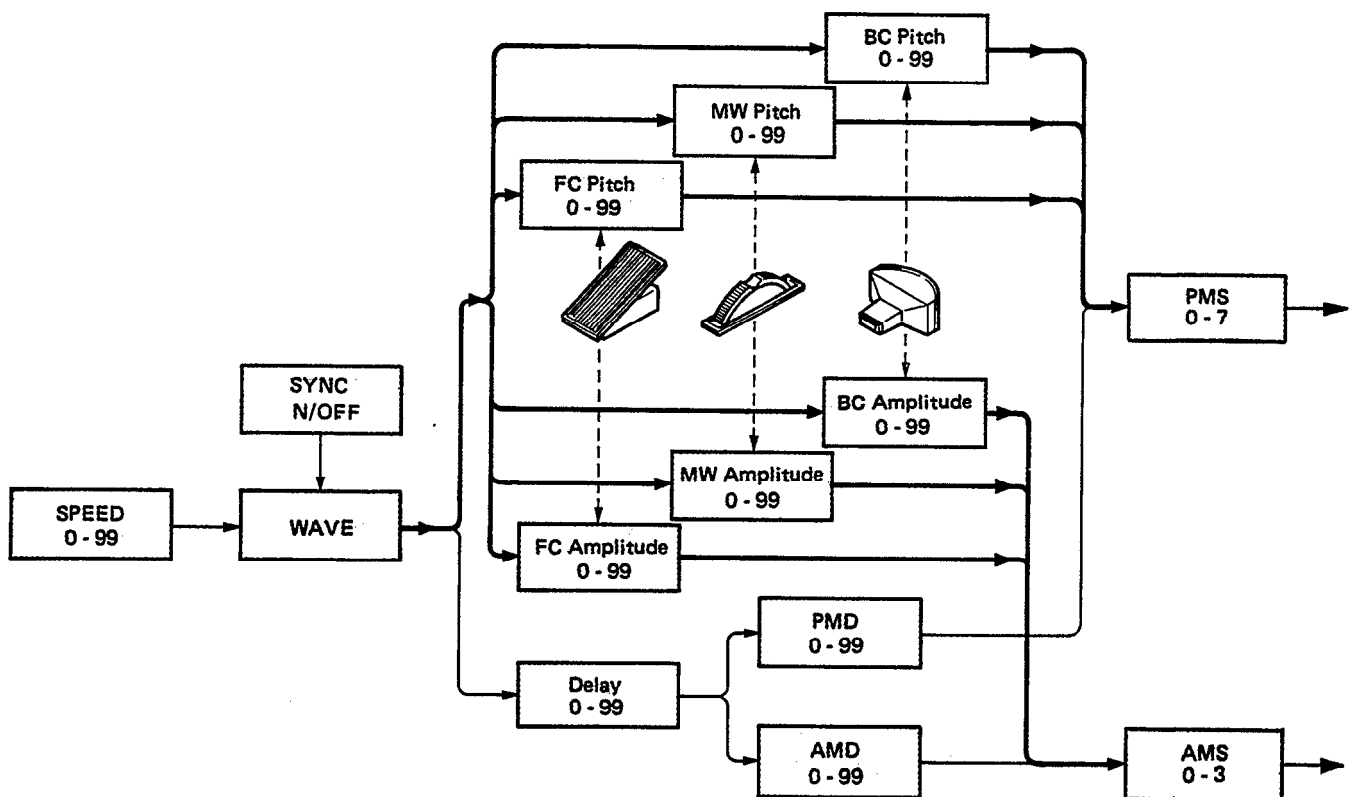
**BC Pitch Bias (-50- +50)**

This allows you to directly control the pitch using a Breath Controller. (This is a "pitch-bending" effect, and has nothing to do with the LFO.) When BC Pitch Bias is set at 0 (the normal value), blowing into the Breath Controller will not affect the pitch. Settings of above 0 will result in the pitch rising when you blow, and settings of below 0 will result in the pitch falling. The further away from 0, the greater the effect.

BC EG Bias (0-99)

This allows you to directly control the output level of the operators using a Breath Controller. The amount of control will depend on the EG Bias Sensitivity for each operator (see p.16) as well as the BC EG Bias setting.

Middle C (C1-C5)

The voice can be transposed up or down 2 octaves in steps of a semitone. The display indicates the note actually sounded when the middle C key (MIDI Note Number 3C) is pressed.

Rev. Rate (off, 1-7)

This is a “pseudo-reverb” effect created by slowing the EG release rates after a certain point. It depends on the OP1 EG. (OP1 on/off or OP1 output level does not matter.) When the EG level of OP1 descends to -18dB, this “pseudo-reverb” is triggered, and the Release Rates of all operators will be slowed down to the Reverb Rate, producing a lingering effect characteristic of reverb.

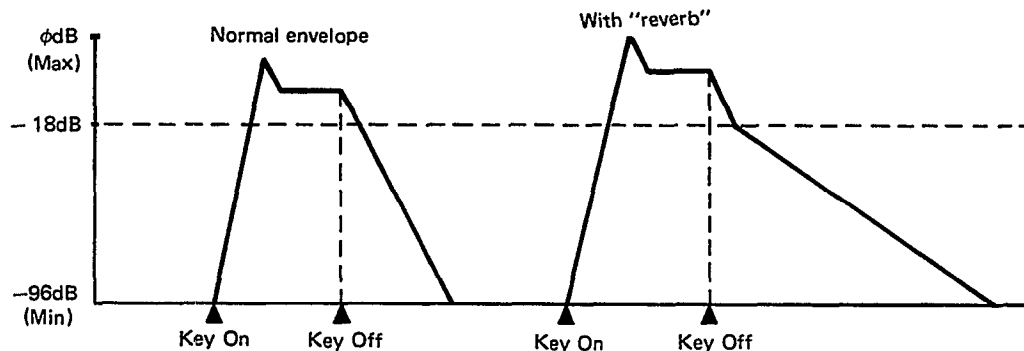

Rev. Rate	Effect
off	No effect
1	EG-Release Rate = 1 (long “reverb”)
2	⋮
7	EG-Release Rate = 7 (short “reverb”)

Note that if the OP1 EG Attack Rate is 0, the sound may linger for quite a while after the note is released. Also, if the EG Release Rate is already less than the Reverb Rate, there will be no effect. This “pseudo-reverb” must be programmed with the other voice parameters in mind.

Name (10 characters)

You can name your newly created voice (or rename a preset voice). Use the CURSOR keys to move the blinking cursor, and use the DATA ENTRY keys to step through the characters shown below.

Space ! " # \$ % & ' () * + , - . / 0 1 2 3 4 5 6 7 8 9
 : ; < = > ? @ A B C D E F G H I J K L M N O P Q R S T U V W X Y Z
 [¥] ^ _ ` a b c d e f g h i j k l m n o p q r s t u v w x y z
 { | } → ←

SINGLE UTILITY

This is where you save and load data to external devices, and perform various other useful functions. These settings are not part of a Performance Memory. They are set for the entire TX81Z. To enter Utility mode, press UTILITY while in PLAY SINGLE or EDIT SINGLE mode.



Select parameters using the PARAMETER keys. If the LCD shows "xxxx ?" you can press YES and use the PARAMETER keys to select the sub-parameters.

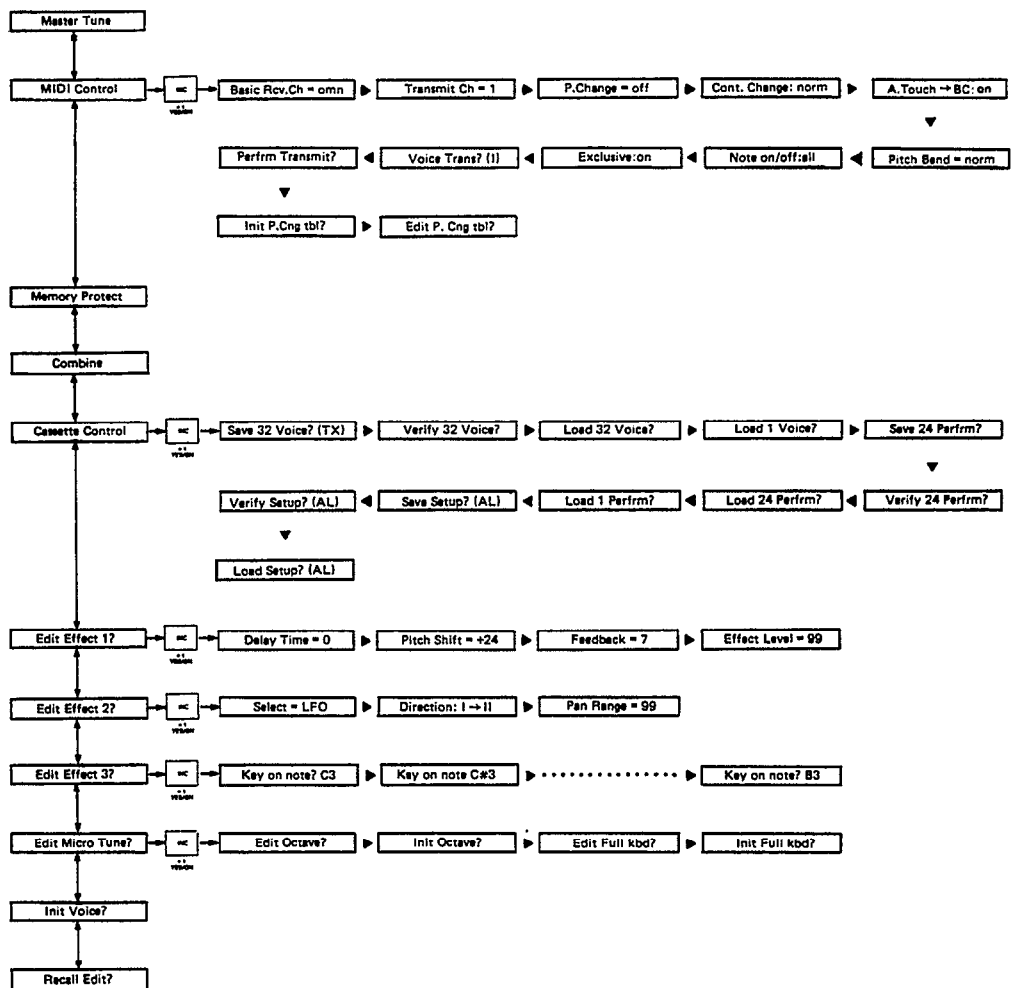

Master Tune

This is the master tune for the entire TX81Z.

Use it to tune the TX81Z to other instruments. The tuning range is one semi-tone (100 cents) below and above standard pitch (A3=440Hz).

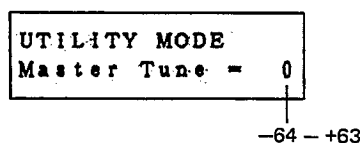

Midi Control?

Answer YES and use the PARAMETER keys to select the following parameters.

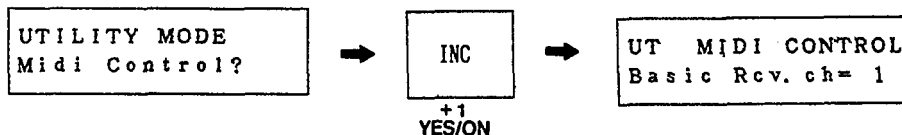

*Receive Channel
(1-16, omni)*

This is the MIDI channel on which the TX81Z will receive System Exclusive data and Program Changes. In SINGLE mode, this is the channel you will play. When this is set to “omn”, all channels will be received.

Transmit Channel (1-16)

This is the MIDI channel on which TX81Z data (bulk voice data, etc.) will be transmitted. When transmitting data to another TX81Z, this must match the receive channel of the other device (unless the receiver is set to “omni”).

*Note on/off
(all, even, odd)*

- All: All note numbers are received (the normal mode).
- Even: Even "
- Odd: Odd "

By using two TX81Zs together and setting one to Even and the other to Odd, you can effectively raise the simultaneous-note capacity to 16 notes.

P. Change (off, corn, ind)

This determines how the TX81Z will react to Program Change messages.

- Off: Ignore program change messages.
- Common: Look up the corresponding Voice Number (I01-D32) or Performance Number (PF1-24) in the Program Change Table (p.26).
- Individual: Each instrument receives program changes separately and looks up its Voice Number from the table. If already in Performance mode and the table entry is a Performance Number, it is ignored.

*Cont. Change
(off, norm, G1-G16)*

- Off: Control Change messages (MIDI messages Bn.xx.yy) will be ignored. This includes messages such as Modulation Wheel, Breath Controller, etc. Sustain pedal on/off will always be received.
- Norm: Control change messages are received normally by each channel.
- G1-16: You can specify a “Global MIDI Channel” for control change messages. In PERFORMANCE mode when a control change arrives on this channel, it will affect all instruments regardless of their channel setting. For example, if a MIDI guitar transmitted Note On messages with a different channel for each string, a Modulation Wheel on the guitar could control all channels simultaneously.

*A. Touch → BC
(off, on)*

Normally the TX81Z does not receive Aftertouch messages (Dn.xx), but when this is set “on”, incoming Aftertouch messages will be treated as Breath Controller (Bn.02.xx) messages. See Control Change, above.

Pitch Bend
(off, norm, G1-G16)

Off: Pitch Bend messages (MIDI messages En.xx.yy) will be ignored.
 Norm: Pitch Bend messages are received normally by each channel.
 G1-16: You can specify a "Global MIDI Channel" for pitch bend messages. In PERFORMANCE mode when a pitch bend message arrives on this channel, it will affect all instruments regardless of their channel setting. For example, if a MIDI guitar transmitted Note On messages with a different channel for each string, a MIDI pitch bend arm on the guitar could control all channels simultaneously.

Exclusive (on, off)

When this is Off, all System Exclusive messages (bulk data) will be ignored, and the TX81Z will not transmit bulk data. (The functions voice, Performance and Setup Transmit will be skipped.)

Voice Transmit?

If you answer YES, the 32 voices in bank I will be transmitted from MIDI OUT. To transmit the 32 voices from another bank (I, A, B, C, D) press NO to select the bank, and YES to transmit it.

Note

This data can be received by another TX81Z (or any data storage device) if its Memory Protect (p.27) is Off, its Exclusive (p.26) is On, and its Receive Channel (p.25) matches the Transmit Channel (p.25). A disk-type MIDI data storage device such as the MDF1 is handy for storing TX81Z data.

Performance Transmit?

If you answer YES, the 24 performance memories will be transmitted from MIDI OUT. (See the note to Voice Transmit, above.)

Setup Transmit?

Press NO to select AL, SY, EF, MC and then press YES to transmit the selected data from MIDI OUT. (See the note to Voice Transmit, above.)

AL All data described below (PC+EF+MC) except System data.
 SY System data. The settings for Combine, Memory Protect, Receive Channel, Transmit Channel, P. Change, Cont. Change, and Exclusive.
 PC Program Change Table (p.26).
 EF Data for the three effects (p.29).
 MC The two user-programmable scales (p.31).

Init P. Ch. Tbl.

When you press YES, the Program Change Table (see below) will be initialized as follows.

Incoming Program Change	will select
PGM 1	I01
PGM 2	I02
}	}
PGM 32	I32
PGM 33	A01
}	}
PGM 128	C32

Edit P. Ch. Tbl.

There is a Program Change Table in TX81Z memory that can be used to “redirect” incoming Program Change messages. When a program change (on the Receive Channel, p.25) is received, this table is consulted, and the corresponding Voice or Performance is selected. To edit the table, answer YES, and use the PARAMETER keys to step through PGM 1 – PGM 128. Use the DATA ENTRY keys to select a Voice number I01-D32 or a Performance number PF01-PF24.

Memory Protect (off, on)

When this is On, you will not be able to store voices or performances nor will the TX receive 32 Voice or 24 Performance bulk data.

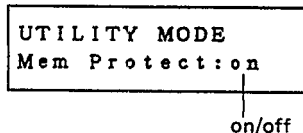

Memory Protect is reset to On when the power is turned on, and after bulk data is received via MIDI or loaded from cassette. Memory Protect is also accessible from Performance Utility mode.

Combine (off, on)

Each voice memory includes Voice Function data (see p.21) that specifies how the voice will respond to MIDI control messages. When Combine is On, each newly selected voice uses its own Voice Function data. By setting Combine Off, you can preserve the current function settings. ie. newly selected voices will use the current settings.

When power is turned on. Combine will be set On.

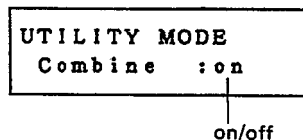

Combine off/on affects the following functions.

- Pitch Bend Range
- Portamento Time
- FC Volume
- FC/MW/BC Pitch and Amplitude
- BC Pitch Bias
- BC EG Bias
- Poly/Mono
- Portamento Mode

Cassette Control?

This is where you save and load data to and from a cassette. Answer YES and use the PARAMETER keys to select the jobs.

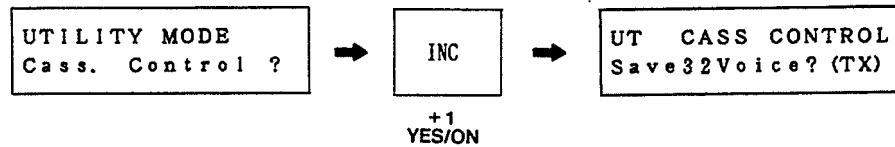

Connect a cassette recorder as shown. It is best to use a cassette recorder and tape especially designed for personal computer data storage. Also try to use the same recorder for both saving and loading. Using the cassette cable included with the TX81Z, connect the white plug to the earphone jack, and the red plug to the microphone jack. If you change your mind while saving, verifying or loading, press NO to quit.

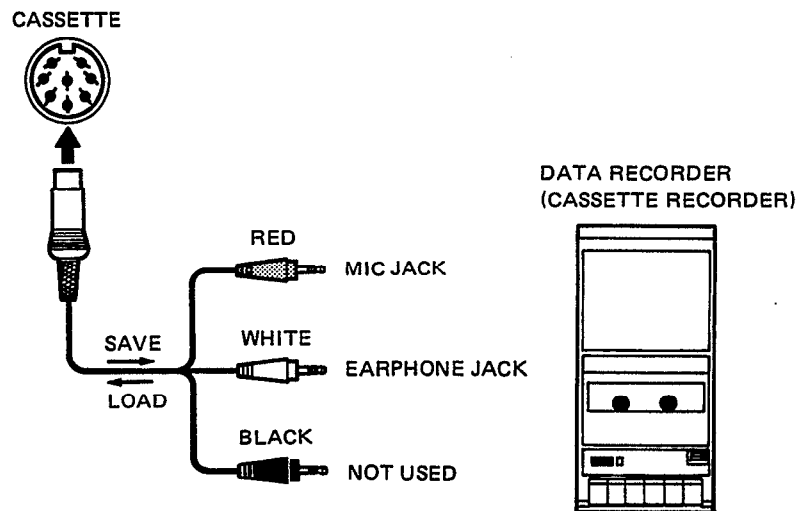
**Save 32 Voice? (TX, DX)**

This will save the 32 voices from the internal memory (bank I) to a cassette tape. You can save the data in TX format or DX format. If you will be re-loading the voice data to a DX100/21/27, press NO to select DX format. (The TX81Z has some parameters that the DX100/21/27 does not, and these will be deleted.)

Press YES, and the LCD will show "Save ready?". Start RECORD on the tape recorder and press YES again.

The LCD will show "INT 01 to Tape" and display the voice number 1-32 that it is currently saving. When saving is complete, the TX81Z will go on to the next job "Verify 32 Voice?".

Verify 32 Voice?

You can check to see whether data was correctly saved to tape. Press YES, and the LCD will read "Verify ready?". Rewind the tape to the beginning of the data, press YES and start the cassette playback. If the data on tape matches the data in the TX81Z, the LCD will show "Verify Completed". If not, the LCD will show "ERR".

Load 32 Voice?

This loads 32 voices from tape into the TX81Z voice memory bank I. Make sure that Memory Protect (p.27) is off, and press YES. The LCD will show "Load all ready?" so press YES again and start the tape playback. The LCD will show "Tape to INT 1" and display the voice number 1-32 currently being loaded. When finished, it will display "Load Completed". If the data from tape is incorrect, it will display "ERR".

SINGLE: Utility

Load 1 Voice?

You can choose any voice (1-32) to load from tape into the voice edit buffer of the TX81Z. Press YES. The LCD will show "Tape ?? to BUFF?" so and use the PARAMETER keys to select the tape data (1-32) you want. Then press YES again and start the cassette playback. The LCD will show "Search Tape xx" and wait for the selected voice data. When the data arrives, the LCD will show "Load Completed". The voice data will be in the edit buffer, so you will need to Store it into a TX81Z voice memory (see p.11). In "Load 1 Voice" mode, you may fast-forward or rewind the tape to get to the voice data you want. (This will not work for any other tape load mode.)

Save 24 Perfm?
Verify 24 Perfm?
Load 24 Perfm?
Load 1 Perfm?

These jobs let you save and load performance data to and from cassette tape. Operation is the same as saving and loading voices, as explained above.

Save Setup?
Verify Setup?
Load Setup?

These jobs let you save and load setup data to and from cassette tape. Press NO to select AL, SY, EF or MC. Operation is the same as saving and loading voices, as explained above.

- AL Program Change Table, Effect and Micro Tune data (PC+EF+MC).
- SY System data. The settings for Combine, Memory Protect, Receive Channel, Transmit Channel, P.Change, Cont.Change, and Exclusive.
- PC Program Change Table (p.26).
- EF Data for the three effects (p.29).
- MC The two user-programmable scales (p.31).

During Load, Verify or Load 1, the format number of the data being read will be shown in the upper right of the LCD. Data of an undesired format will be skipped.

Edit Effect 1? (Delay)

This is a transposed delay effect. You can use it while setting the effect or in a performance (the first active instrument will be used). Press YES, and use the PARAMETER keys to select the four Delay parameters. This Delay effect is made by producing additional notes with reduced velocity until the velocity reaches 18. If the voice is not velocity sensitive (p.16), each echo will be the same "volume" as the original note, even though the velocity is being decreased. You can take advantage of this to control the number of repeats by how hard you play the note. (Especially effective when used with some Pitch Shift.) Up to four delay notes can be sounding simultaneously. When the fifth delay note is played, the first delay note will stop.



Delay Time (0.01-1.28s)

This is the time between echoes, displayed in seconds.

Pitch Shift? (-24 - +24)

You can transpose each delayed note up or down by semitones. -24 is two octaves down, and +24 is two octaves up. However, the TX81Z note range is limited to about 8 octaves, and notes falling outside of this range will be "folded back."

Feedback (0-7)

This regulates how the Velocity of each echo is decreased, and indirectly determines the number of echoes. If you play a note strongly (high velocity), there will be more repeats before the velocity drops to 18.

Effect Level (0-99)

This determines the Velocity of the first echo. When set to 99, the first echo will have the same velocity as the note you play. As with Feedback, this will indirectly determine the number of echoes.

Edit Effect 2 (Pan)

This effect automatically moves the sound between outputs I and II. You can use it while setting the effect or in a performance when 2 instruments are active. Press YES, and use the PARAMETER keys to select the three Pan parameters.

This pan effect is produced by varying the balance of two instruments assigned to outputs I and II. Thus, to create a natural panning effect, both instruments should be using the same voice.

When Pan is used in PLAY SINGLE mode, the TX81Z will automatically act as two identical instruments (one assigned to output I, the other to output II), each playing up to four notes.

When Pan is used in a performance, you need to make sure that at least two instruments are assigned to different outputs. (It is possible to use Pan on all eight instruments if each is assigned to either output I or II)

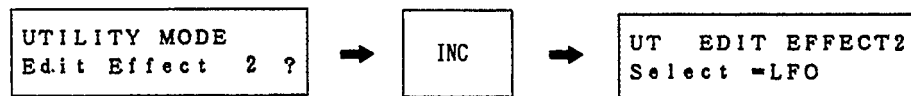

Select (LFO, Velocity, Note) This determines the source of the movement.

LFO: The sound will be panned back and forth at the LFO speed (p.14).

Velocity: Notes with low velocity (softly played) will be panned toward output I, and notes with high velocity (strongly played) will be panned toward output II. (This will be reversed if you select "Direction: II-I".)

Note: Low notes (to the left of the keyboard) will be panned toward output I, and high notes toward output II. (This will be reversed if you select "Direction: II-I".)

Direction (I-II, II-I)

This determines the direction of the panning movement, from output I → II or the reverse.

Range (0-99)

This determines the range of the pan effect. At low settings the sound will barely move, and at high settings the sound will be panned completely to one or the other output.

Edit Effect 3 (Chord)

This effect allows you to produce up to four simultaneous notes for each note you play, You can use it while editing the effect or in a performance (the first active instrument will be used). Press YES, then press PARAMETER to select the Key on note.

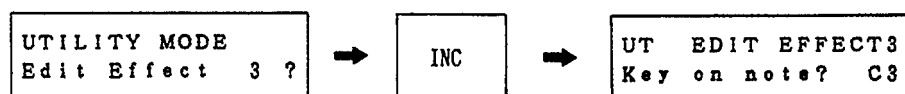

Press YES and the chord notes currently selected for that note will be displayed.

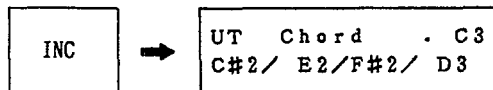

Now press up to four notes on the keyboard. When you release all the notes, the new chord notes will be displayed. If less than four notes are pressed, a "*" fills the empty space. In this way, you can specify up to 12 notes and a four-note chord for each. You can also use DEC/INC to specify the chord notes within a ±2 octave range. The blinking cursor will appear when you press DEC/INC.

Micro Tune?

The TX81Z has 13 microtonal scales (11 preset and 2 user-programmable), one of which can be selected for use in a performance (p.41). This is where you edit the two user-programmable scales. Press YES and use the PARAMETER keys to select the four jobs.

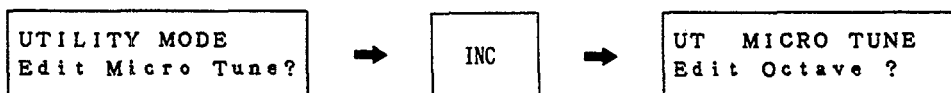

Edit Octave?

Here you can edit the 12 notes of the user-programmable octave. The tuning of each note will be repeated in steps of 1200 cents (one octave) up and down the keyboard. Press YES. Use the PARAMETER keys to select C3-B3 and use DEC/INC to change the tuning for each note. As you change the tuning, the absolute pitch is calculated and displayed in steps of 100/64 cent (about 1.56 cents) ranging from 0 (C#-1+0) to 6143 (C7+32). This covers the entire range of the TX81Z's sound-producing capability.

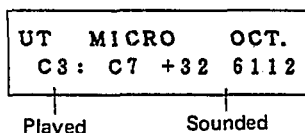

Init Octave?

Here you can initialize the user-programmable octave to one of the 11 preset scales. When creating your own scale, it may be faster to start with one of these preset scales. Press YES and use the PARAMETER keys to select preset scales 1-11. You can play the keyboard to hear the currently selected scale. Press YES again to initialize to the selected scale. (Press NO to escape.) For Pure, Mean Tone and Pythagorean scales, you can also choose the tonic (first note) of the scale. Move the cursor to the "key" area and select C-B using the PARAMETER keys. (No matter what tonic you select, A3 will always be 440Hz.)

- | | |
|-----------------|---------------------|
| 1: Equal | 7: Kirnberger |
| 2: Pure (major) | 8: Vallotti & Young |
| 3: Pure (minor) | 9: 1/4 Shift eql |
| 4: Mean tone | 10: 1/4 Tone |
| 5: Pythagorean | 11: 1/8 Tone |
| 6: Werckmeister | |

For the tuning details of scales 1 to 8, see the data tables on page 49. 1/4 Shifted Equal Temperament (scale 9) is the normal scale shifted up 50 cents. When 1/4 Tone (scale 10) is used, each key produces an interval of 50 cents (ie. play 24 keys to move one octave). When 1/8 Tone (scale 11) is used, each key produces an interval of 25 cents (ie. play 48 keys to move one octave). When 1/4 tone or 1/8 tone are used, the C2 key (key number 48) will produce the pitch of normal C3.

Edit Full Kbd?

Here you can edit the tuning of each note in the scale from C#-1 to C7 (the full range of the TX81Z's sound producing capability. As explained in "Edit Octave", use the PARAMETER keys to select the note and use DEC/INC to change the tuning for each note. You can also select a note by playing it on the keyboard and pressing a PARAMETER key.

Init Full Kbd?

Here you can initialize the user-programmable full scale to one of the 11 preset scales as described in "Init Octave".

Init Voice?

This will set the voice data in the edit buffer to the settings shown below.

```

UTILITY MODE
Init Voice?
  
```

When creating a voice from scratch, it is often useful to start from this "basic setting" rather than having to reset all the parameters by hand. Press YES. The LCD will ask "Are you sure?", press YES again. The edit buffer will be set to the voice data shown below, and you will automatically enter Edit Mode (p.12).

INITIAL VOICE-DATA

ALG	=	1	(Mode)	=	RATIO	Poly Mode	
Feedback	=	0	OSW	=	W1 (sine)	P Bend Range	= 4
Wave	=	triangl	DET	=	0	Full Time Porta	
Speed	=	35	AR	=	31	Porta Time	= 0
Delay	=	0	D1R	=	31	FC Volume	= 40
P Mod Depth	=	0	D1L	=	15	FC Pitch	= 0
A Mod Depth	=	0	D2R	=	0	FC Amplitude	= 0
Sync	=	off	RR	=	15	MW Pitch	= 50
P Mod Sens.	=	6	SHFT	=	off	MW Ampli	= 0
AMS	=	0	OUT	=	90 OP1	BC Pitch	= 0
AME	=	off			0 2	BC Amplitude	= 0
EBS	=	0			0 3	BCP Bias	= 0
KVS	=	0			0 4	BC EG Bias	= 0
(Frequency)	=	1.00	RS	=	0	Middle C	= C3
			LS	=	0	Reverb Rate	= off
						Name	= INIT
							VOICE

Recall Edit?

This recalls the last edited voice into the edit buffer. For example, if you are editing a voice and accidentally select a voice memory, the voice data from memory will be loaded into the edit buffer and your edited settings will be lost. By using this "Recall Edit" function, you can restore the data you were editing.

```

UTILITY MODE
Recall Edit?
  
```

Press YES. The LCD will ask "Are you sure?" so press YES again. The data you were editing will be loaded into the edit buffer, and you will automatically enter Edit Mode (p.12).

PERFORMANCE MODE

In performance mode, you can use the TX81Z as up to eight independent instruments, and preset the maximum number notes, note limit, reception channel, voice number, etc. for each instrument. The TX81Z will remember up to 24 of these "Performances".

Data (voice numbers, performance parameters etc.) for each instrument is shown in the lower line of the LCD. However, the LCD has space to display only four instruments at once, so use the CURSOR keys to move the blinking cursor to instruments 5-8.

PLAY PERFORMANCE

Using the DATA ENTRY keys, select performances 1-24. The upper line of the LCD will show the Performance Name, and the lower line will show the voice numbers for each instrument. (Move the cursor to the right to see the voice numbers for instruments 5-8). If the "Max Notes" setting of an instrument is 0, the voice number will show a "*" indicating an inactive instrument. The PARAMETER keys do not function in PLAY PERFORMANCE mode.

Performance number and name

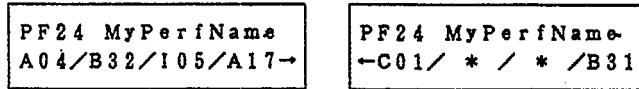

Instruments 1-4

Instruments 5-8



CURSOR

Each Performance Memory (1-24) contains the following data.

Instrument	1	2	3	4	5	6	7	8
Assign Mode	Normal / Alternate							
Max Notes (0-8)								
Voice No. (I01-D32)								
Receive Ch. (1-16, omni)								
Limit/L (C-2-G8)								
Limit/H (C-2-G8)								
Inst Detune (-7 - +7)								
Note Shift (-24 - +24)								
Volume (0-99)								
Out Assign (off, I, II, I II)								
LFO Select (off, 1, 2, vib)								
Micro Tune (select)	off/on	off/on	off/on	off/on	off/on	off/on	off/on	off/on
Effect Select	off / Delay / Pan / Chord							
Performance name								

There is a blank Performance Memory chart on p.63 that you may copy and use as a memo for your own settings.

STORE PERFORMANCE

You can store the currently selected performance (edited or not) in any performance memory 1-24. While in PLAY PERFORMANCE mode, press and hold the STORE key. The LCD will ask

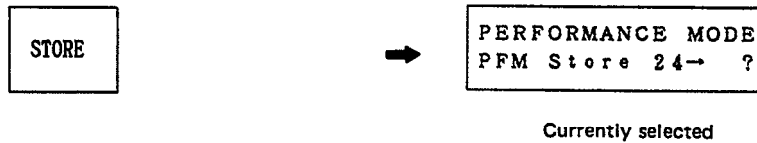

so continue holding STORE and use the DATA ENTRY keys to select the store destination (1-24).

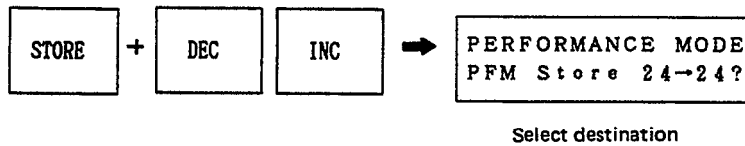

When the LCD shows the destination you want, release STORE and press YES. The performance will be stored into the selected memory. (You can quit without storing by pressing NO.)

Note

When the TX81Z is shipped, performance memories 1-24 contain the data listed on pages 51-62. Before storing your own performances, you may wish to save this data. See Save 24 Performance, p.29.

PERFORMANCE EDIT

In PERFORMANCE mode, press EDIT/COMPARE. The LED will light, and the LCD will show the previously edited parameter. When you first enter Edit Performance mode, the upper left character of the LCD will be a "P", but as soon as you make a change, this will change to "p", indicating that the performance data has been modified.



EDITING PROCEDURE

Use the PARAMETER keys to move through the parameters. Most Performance Parameters have independent settings for instruments 1-8. The LCD has space to show only four instruments at once, so an arrow "→" on the lower line indicates that there is more data to be seen. Move the cursor to set the data for instruments 5-8. (The CURSOR LED will automatically come on when you enter EDIT mode.) Use the DATA ENTRY keys to change the data value at the blinking cursor.

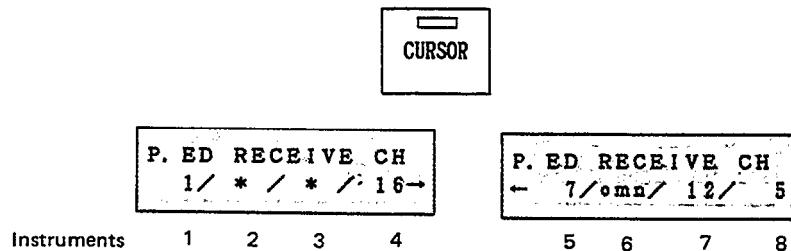

If the Max Notes setting (p.38) of an instrument is 0, that instrument is inactive, and its data will be indicated by a "*". (You can not edit an inactive instrument.) In the example above, instruments 2 and 3 are inactive. Unlike Voice Edit mode, this mode has no Compare (p.13) function.

THE PERFORMANCE EDIT BUFFER

When you select a Performance Memory, the data is loaded into the Performance Edit Buffer, and this data tells the TX81Z how to behave. Changes you make in Edit mode affect this buffer, and are not permanent until Stored into one of the Performance Memories 1-24. (See Store Performance p.36.)

Assign Mode

This sets the key assign mode.

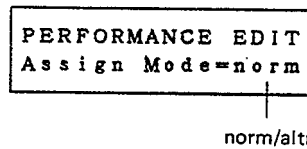

In Normal mode, incoming MIDI Note On messages will play the instrument that has a matching Reception Channel (p.39). Alternate mode is rather special. Only those incoming notes that match the Reception Channel of instrument 1 will be played, and each successive note will be sounded by the next instrument. Thus, every eighth note will be sounded by the same instrument. Setting the 8 instruments to voices that are slightly different can be quite effective.

Max Notes

This sets the maximum number of notes that an instrument can produce.

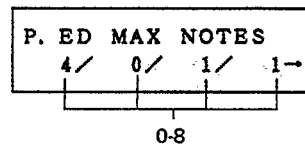

The TX81Z can produce up to 8 notes at once. These 8 notes must be divided among the 8 instruments. ie. the total Max Notes settings of the 8 instruments can not exceed 8. If one instrument is to play chords of up to 8 notes, the Max Notes setting for the other 7 instruments must be 0. Any combination is possible. If Max Notes is set to 0, that instrument will be inactive. When editing other Performance Parameters, a "*" will appear in place of that instrument's data, and you will not be able to edit it.

A Max Notes setting of 1 is not exactly the same as setting the voice to Mono mode. See p.21.

Voice No.

Select the voice number for each instrument.

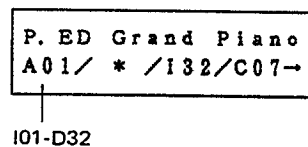

Use the DATA ENTRY keys to select voices I01-D32. The upper line of the LCD will show the Voice Name for the instrument indicated by the blinking cursor.

Receive Ch.

Select the MID I reception channel for each instrument.

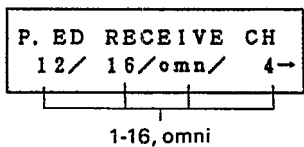

When set to “omni”, messages on any channel (1-16) will be received.

Limit /L

Incoming notes below this limit will be ignored.

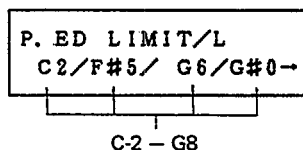

Limit /H

Incoming notes above this limit will be ignored.

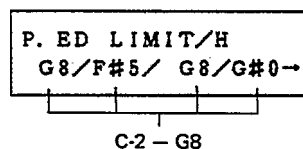

You can use the Low and High note limits to create a “split” effect. One instrument could play notes below C3, and another instrument (set to a different voice) play notes above D#3. It is possible to set the Low limit above the High limit, in which case the instrument would play notes at the ends of the keyboard and not in the middle range.

Detune

Each instrument can be tuned independently.

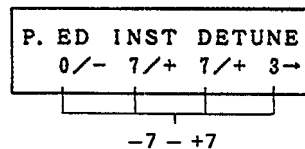

Note Shift

Each instrument can be transposed independently in steps of a semitone. A setting of -24 is two octaves down, and +24 is two octaves up.

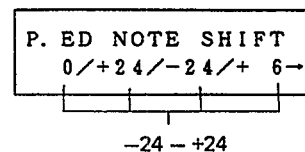

Volume

The volume of each instrument can be set independently. A vertical bar beside each number graphically indicates the volume.

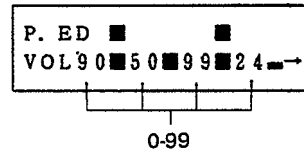
**Note**

When an instrument receives a MIDI Control Change Bn.07.xx (volume), this setting will be defeated, ie. MIDI will set the volume regardless of this setting. If you want to set the volume of an instrument so that MIDI will control the volume within a setting, set the operator output levels of the carriers (p.20) in the voice data.

Out Assign

The output of each instrument can be assigned to either or both of the rear panel outputs.

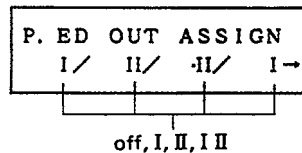

LFO Select

This selects the source of LFO modulation for each instrument.

When "off" is selected, the instrument will use neither Amplitude modulation nor Pitch modulation.

When "vib" is selected, the instrument will use the LFO settings from its own currently selected voice memory, but there will be no Amplitude modulation. (Thus, if you need only Pitch modulation, each instrument can have its own independent LFO.)

If an instrument is to use Amplitude modulation, it must share the LFO of either the first or second instrument in the performance. The display will indicate the instrument number (1-8) who's LFO will be used. If only one instrument is active, "---" will be displayed instead of the second instrument number.

In the display below, instrument 1 is inactive (its Max Notes setting is 0), so instrument 2 is the "first" instrument. Set as shown, instrument 2 will use its own LFO (with Amplitude modulation), instrument 3 will use its own LFO (without Amplitude modulation), and instrument 4 will use the LFO of instrument 3 (with Amplitude modulation).

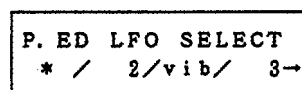

off, (first), (second), vib

Micro Tune

The TX81Z has 13 Micro Tuning Tables (see p.49) in its memory; 11 are preset (see p.31) and the other two (one Octave and one Full) can be edited. You can select one of these 13 tables for use in a performance, and specify whether or not (on/off) each instrument 1-8 will use the selected Microtone Table. When Micro Tune is on, that instrument will produce the pitch indicated by the data in the selected Microtuning Table. When Micro Tune is off, that instrument will play the normal (tempered) scale. In the example below, instruments 2 and 3 will use the preset 1 scale.

Oct. / Full / 1-11 / C-B

```

P. ED MICTUN=1 Eb
off/ on/ on/off-
    
```

on/off

Effect Select

Each performance can use one of the three effects (see p.29). When the Delay or Chord effect is selected, only the first active instrument will be used. Pan will only affect instruments assigned to output I or II (not both).

```

PERFORMANCE EDIT
Effect Sel=off
    
```

off/Delay/Pan/Chord

Performance Name

You can give a Performance Memory a 10-character name. Use the CURSOR keys to move the blinking cursor, and use the DATA ENTRY keys to select the character. A list of the available characters is given on p.23.

```

PERFORMANCE EDIT
Name: MyPerfName
    
```

PERFORMANCE UTILITY

While in PERFORMANCE mode, press UTILITY and use the PARAMETER keys to select the job you want.



Voice Edit

This lets you edit one of the voices in the currently selected performance. You will jump to SINGLE Edit mode (p.12) when you press YES.

```
P. UT VOICE EDIT?
A14/117/C02/C08→
```

Init Perfrm?

This lets you initialize the Performance Buffer to one of the standard settings shown on pages 43-45.

```
P. UTILITY Singl
Init Perfrm?
```

Singl/dual/split/mono 8/poly 4

Press NO to select the initialization setting you want. When the LCD shows the desired setting, press YES. You will be asked "Are you sure?" so press YES again.

PERFORMANCE: Utility

Performance name	SINGLE							
Instrument	1	2	3	4	5	6	7	8
Assign Mode	Normal / Alternate							
Max Notes (0-8)	8	0	0	0	0	0	0	0
Voice No. (I01-D32)	I01	I01	I01	I01	I01	I01	I01	I01
Receive Ch. (1-16, omni)	1	2	3	4	5	6	7	8
Limit /L (C-2 – G8)	C-2	C-2	C-2	C-2	C-2	C-2	C-2	C-2
Limit /H (C-2 – G8)	G8	G8	G8	G8	G8	G8	G8	G8
Detune (-7 – +7)	0	0	0	0	0	0	0	0
Note Shift (-24 – +24)	0	0	0	0	0	0	0	0
Volume (0-99)	99	99	99	99	99	99	99	99
Out Assign (off,I,II,I II)	I II	I II	I II	I II	I II	I II	I II	I II
LFO Select (off,1,2,vib)	1	2	vib	vib	vib	vib	vib	vib
Micro Tune (select) Oct.	off /on	off /on	off /on	off /on	off /on	off /on	off /on	off /on
Effect Select	off / Delay / Pan / Chord							

Performance name	DUAL							
Instrument	1	2	3	4	5	6	7	8
Assign Mode	Normal / Alternate							
Max Notes (0-8)	4	4	0	0	0	0	0	0
Voice No. (I01-D32)	I01	I01	I01	I01	I01	I01	I01	I01
Receive Ch. (1-16, omni)	1	1	3	4	5	6	7	8
Limit /L (C-2 – G8)	C-2	C-2	C-2	C-2	C-2	C-2	C-2	C-2
Limit /H (C-2 – G8)	G8	G8	G8	G8	G8	G8	G8	G8
Detune (-7 – +7)	0	+2	0	0	0	0	0	0
Note Shift (-24 – +24)	0	0	0	0	0	0	0	0
Volume (0-99)	99	99	99	99	99	99	99	99
Out Assign (I,II,I+II)	I II	I II	I II	I II	I II	I II	I II	I II
LFO Select (off,1,2,vib)	1	2	vib	vib	vib	vib	vib	vib
Micro Tune (select) Oct.	off /on	off /on	off /on	off /on	off /on	off /on	off /on	off /on
Effect Select	off / Delay / Pan / Chord							

Performance name	SPLIT							
Instrument	1	2	3	4	5	6	7	8
Assign Mode	Normal / Alternate							
Max Notes (0-8)	4	4	0	0	0	0	0	0
Voice No. (I01-D32)	I01	I01	I01	I01	I01	I01	I01	I01
Receive Ch. (1-16, omni)	1	1	3	4	5	6	7	8
Limit/L (C-2 – G8)	C-3	C-2	C-2	C-2	C-2	C-2	C-2	C-2
Limit /H (C-2 – G8)	G8	B2	G8	G8	G8	G8	G8	G8
Detune (-7 – +7)	0	0	0	0	0	0	0	0
Note Shift (-24 – +24)	0	0	0	0	0	0	0	0
Volume (0-99)	99	99	99	99	99	99	99	99
Out Assign (I,II,I+II)	I II	I II	I II	I II	I II	I II	I II	I II
LFO Select (off,1,2,vib)	1	2	vib	vib	vib	vib	vib	vib
Micro Tune (select)	Oct.	off /on	off /on	off /on	off /on	off /on	off /on	off /on
Effect Select	off / Delay / Pan / Chord							

Performance name	MONO8							
Instrument	1	2	3	4	5	6	7	8
Assign Mode	Normal / Alternate							
Max Notes (0-8)	1	1	1	1	1	1	1	1
Voice No. (I01-D32)	I01	I02	I03	I04	I05	I06	I07	I08
Receive Ch. (1-16, omni)	1	2	3	4	5	6	7	8
Limit /L (C-2 – G8)	C-2	C-2	C-2	C-2	C-2	C-2	C-2	C-2
Limit /H (C-2 – G8)	G8	G8	G8	G8	G8	G8	G8	G8
Detune (-7 – +7)	0	0	0	0	0	0	0	0
Note Shift (-24 – +24)	0	0	0	0	0	0	0	0
Volume (0-99)	99	99	99	99	99	99	99	99
Out Assign (I, II, I+II)	I II	I II	I II	I II	I II	I II	I II	I II
LFO Select (1,2, vib)	1	2	vib	vib	vib	vib	vib	vib
Micro Tune (select)	Oct.	off /on	off /on	off /on	off /on	off /on	off /on	off /on
Effect Select	off / Delay / Pan / Chord							

PERFORMANCE: Utility

Performance name	POLY4							
Instrument	1	2	3	4	5	6	7	8
Assign Mode	(Normal) / Alternate							
Max Notes (0-8)	2	2	2	2	0	0	0	0
Voice No. (I01-D32)	I01	I02	I03	I04	I05	I06	I07	I08
Receive Ch. (1-16, omni)	1	2	3	4	5	6	7	8
Limit /L (C-2 – G8)	C-2	C-2	C-2	C-2	C-2	C-2	C-2	C-2
Limit /H (C-2 – G8)	G8	G8	G8	G8	G8	G8	G8	G8
Detune (-7 – +7)	0	0	0	0	0	0	0	0
Not Shift (-24 – +24)	0	0	0	0	0	0	0	0
Volume (0-99)	99	99	99	99	99	99	99	99
Out Assign (I, II, I+II)	I II	I II	I II	I II	I II	I II	I II	I II
LPO Select (1, 2, vib)	1	2	vib	vib	vib	vib	vib	vib
Micro Tune (select) Oct.	(off) /on	(off) /on	(off) /on	(off) /on	(off) /on	(off) /on	(off) /on	(off) /on
Effect Select	(off) / Delay / Pan / Chord							

Memory Protect

This is the very same function described in SINGLE UTILITY (p.27).

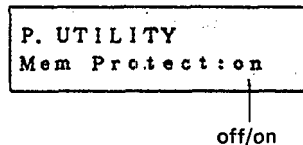

When Memory Protect is on, you will not be able to store a Voice or Performance, and incoming MIDI bulk data will be ignored.

OTHER FUNCTIONS

Greeting Message

When you turn the TX81Z power on, it displays a greeting message, initially set to "<Good morning!!>". You can change this by turning the power on while pressing STORE. Use the CURSOR keys to move the blinking cursor and use DEC/INC to select characters. (The character table is on p.23.) When you are finished, press PARAMETER, EDIT or PLAY to return to normal operation.

The next time you turn the power on, your new message will be displayed.

Minimum Volume

The Master Volume control (p.3) controls the volume of the entire TX81Z. When it is set to 0, there will be no sound, If the Master Volume is less than 30, it will automatically be reset to 30 when the power is turned on.

MIDI Note Indicator

When a MIDI Note On message arrives while in PLAY mode (single or performance), the PLAY LED will blink. This is irrespective of the Receive Channel setting, and the LED will blink even if the note was not actually sounded.

However, if Key Number (p.25) is set to Odd or Even, only corresponding notes will make the LED blink.

Note Range

The TX81Z can produce notes in the range from C#-1 to C7. Incoming notes beyond this range will be "folded back" to the nearest octave.

Battery Backup

The TX81Z internal RAM memory (voice memory bank I, 24 performance memories, effects 1-3, etc.) is backed up by a battery to retain data even when the power is turned off. The life of this battery is approximately 5 years. Have it replaced by an authorized Yamaha technician within 5 years of purchase. (Don't forget to save the internal data to a storage device such as cassette before having the battery changed.)

IDEAS AND SUGGESTIONS

The TX81Z can be used in any number of ways. Here are some ideas.

PERCUSSION

Double the RX rhythm machine sounds with TX sounds.

Most rhythm machines can be set to transmit a specified MIDI note number when a percussive voice is sounded. You can use the TX81Z to produce 8 percussive sounds, and set the High and Low note limits to the same note, so that each TX instrument can be played only by a single note number. For example, a Yamaha RX rhythm machine can send an E2 Note On message when the snare drum sounds. This could play a TX percussive voice, producing a unique blend. (The Fixed Frequency mode is especially useful when programming percussive voices. See p.17.) Or you could simply play the TX81Z percussive voices from a keyboard. Bass Drum on C, Snare on Eb-F (it's easier to play a drum roll when you have several keys), Crash Cymbal on F#, etc.

— Note —

Rhythm machines send a Note Off message quickly after the Note On message. If this interval is too short, the TX may not have time to sound. Try setting the Release Rate to a lower value.

HEAVY MONOPHONIC

If your solo is going to be monophonic, how about playing 8 TX instruments in unison? Set each instrument to receive the same MIDI channel, and assign different voices (and different detunings) to each. Setting a slightly different Portamento Time (or Pitch Bend Range) for each instrument is also effective. This will give you the thickest, richest, most powerful solo sound you ever heard; one that will “out-analog” the analog synthesizers(!).

HUMAN EXPRESSION

In a variation of the above, use several different voices to synthesize a different component of an acoustic instrument sound, in essence using the TX as a single 32-operator FM synthesizer. For example, a saxophone sound consists of many different elements, one of which is the breathy wind-noise. An entire TX instrument could be devoted producing this wind-noise. By appropriate settings of the Voice Functions, each component can be controlled independently by Foot Controller, Breath Controller, Modulation Wheel and Key Velocity.

MICROTONAL DETUNE BY AREA

A microtonal scale can be selected for use with specified instruments in a Performance. Set up the TX81Z as two 4-note polyphonic instruments, and set one of them to use the user-programmable Full Keyboard microtonal scale. Set the microtonal scale so that it is identical to the equal tempered (normal) scale, and detune just the notes where you want the detuned chorus effect.

DX21/27/100 COMPATIBILITY

The TX81Z uses the same 4-operator, 8-algorithm FM synthesis as the DX21, DX27 and DX100, and voice data can be transmitted and received between them. However, the TX81Z has a number of features that the DX21/27/100 does not.

*The Frequency CRS(RATIO) adjustment (p.17) is equivalent to the values programmable in the DX21/27/100. The FIN(RATIO) adjustment is additional precision available in the TX81Z. Also, the DX21/27/100 operators have no FIX mode.

*The DX21/27/100 operators produce only sinewaves. When a TX81Z voice that uses non-sinewave operators (p.18) is loaded into a DX21/27/100, it will not sound the same.

*EG RR. The Envelope Generator Release Rate on the DX21/27/100 can be set to 0, whereas the TX81Z EG-RR minimum setting is 1. When voice data is received from a DX21/27/100, any EG release rates of 0 are set to 1.

*EG-EG Shift is not a parameter on the DX21/27/100, and will be ignored when you load data from the TX81Z.

*Parameters which the TX81Z does not have (PEG, chorus) will be set to Off or 0.

*The TX81Z BC Pitch Bias of -50 to +50 (p.22) corresponds to the DX27/100 BC Pitch Bias of 0-99. However, the curve is different, (Exponential, not linear.)

MICRO TUNING DATA TABLE

KEY (CENT)	Equal	Pure C (major)	Pure A (minor)	Mean Tone C	Pythago- rean C	Werck- meister	Kirnberger	Vallotti & Young
*C	0	0.000	0.000	0.0000	0.000	0.000	0.000	0.000
*C#	100	70.673	70.673	76.0490	113.685	90.225	90.225	94.135
*D	200	203.910	182.404	193.1569	203.910	192.180	193.157	196.090
*D#	300	315.641	315.641	310.2647	294.135	294.135	294.135	298.045
*E	400	386.314	384.314	386.3137	407.820	390.225	386.314	392.180
*F	500	498.045	498.045	503.4216	498.045	498.045	498.045	501.955
*F#	600	568.718	568.718	579.4706	611.730	588.270	590.224	592.180
*G	700	701.955	701.955	696.5784	701.955	696.090	696.578	698.045
*G#	800	772.628	772.628	772.6274	815.640	792.180	792.180	796.090
*A	900	884.359	884.359	889.7353	905.865	888.270	889.735	894.135
*A#	1000	1017.596	1017.596	1006.8432	996.090	996.090	996.090	1000.000
*B	1100	1088.269	1088.269	1082.8921	1109.775	1092.180	1088.269	1090.225
*C	1200	1200.000	1200.000	1200.0000	1200.000	1200.000	1200.000	1200.000
*C-C#	100	70.673	70.673	76.0490	113.685	90.225	90.225	94.135
*C#-D	100	133.237	111.731	117.1079	90.225	101.955	102.932	101.955
*D-D#	100	111.731	133.237	117.1078	90.225	101.955	100.978	101.955
*D#-E	100	70.673	70.673	76.0490	113.685	96.090	92.179	94.135
*E-F	100	111.731	111.731	117.1079	90.225	107.820	111.731	109.775
*F-F#	100	70.673	70.673	76.0490	113.685	90.225	92.179	90.225
*F#-G	100	133.237	133.237	117.1078	90.225	107.820	106.354	105.865
*G-G#	100	70.673	70.673	76.0490	113.685	96.090	95.602	98.045
*G#-A	100	111.731	111.731	117.1079	90.225	96.090	97.555	98.045
*A-A#	100	133.237	133.237	117.1079	90.225	107.820	106.355	105.865
*A#-B	100	70.673	70.673	76.0489	113.685	96.090	92.179	90.225
*B-C	100	111.731	111.731	117.1079	90.225	107.820	111.731	109.775
*C-C	1200	1200.000	1200.000	1200.0000	1200.000	1200.000	1200.000	1200.000

This table shows the theoretical values. Actual data in the TX81Z is in steps of approximately 1.56 cents.

WAVEFORM HARMONIC CONTENT

In addition to sinewaves (pure tones), the TX81Z operators can use 7 more complex waveforms. These waveforms are not modeled after any "real" instrument, but are mathematical transformations of sinewaves. Here is the harmonic content of each waveform. The amplitude (volume) of each harmonic partial is given as a percentage of the fundamental.

W1

Sine wave. Only fundamental.

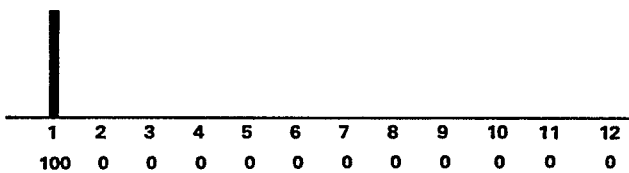

W2

Odd partials somewhat like a square wave

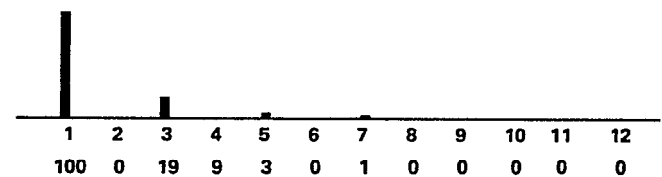

W3

Even partials.



W4

Partials 2, 3, 5, 7,

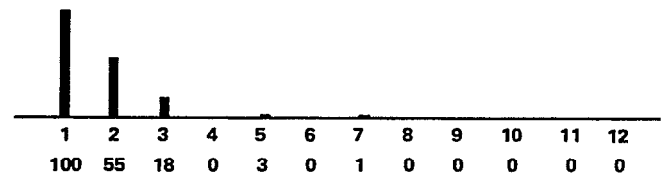

W5

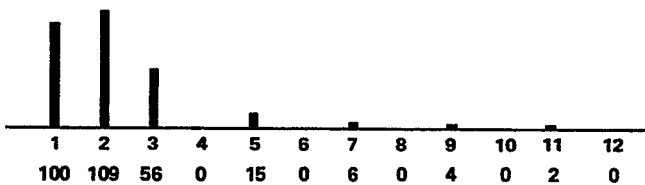
Partials 2, 3, 5, 7, 9 (stronger partials than W4)
Second partial is stronger than fundamental.

W6

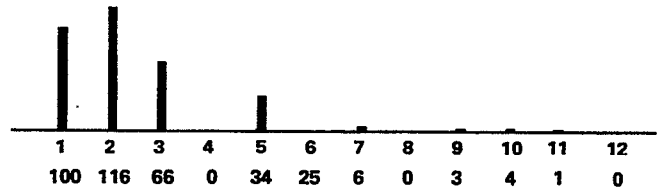
Partials 2, 3, 5, 6, 7, 9, 10, 11, . . . (no 4, 8,)
Second partial is stronger than fundamental.

W7

Partials 3, 4, 5, 7, 8, 9, . . . (no 2, 6, 10, . . .)

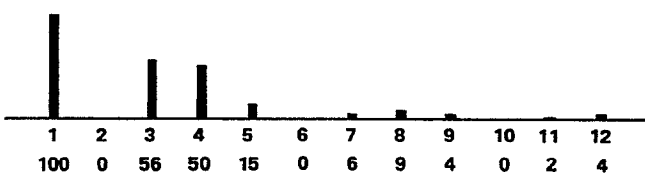

W8

Partials 3, 4, 5, 7, 8, 11, (no 2, 6, 8, 10)

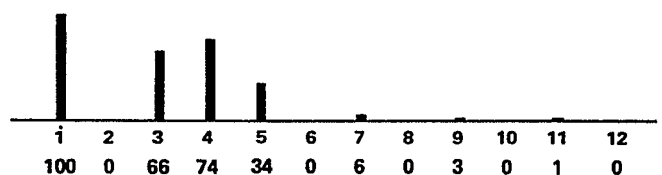

PERFORMANCE DATA

Performance No. 1

Performance name	Acoustic Guitar							
Instrument	1	2	3	4	5	6	7	8
Assign Mode	Alternate							
Max Notes (0-8)	1	1	1	1	1	1	1	1
Voice No. (I01-D32)	C01	C01	C01	C01	C01	C01	C01	C01
Receive Ch. (1-16), omni)	1	1	1	1	1	1	1	1
Limit /L (C-2 – G8)	C-2	C-2	C-2	C-2	C-2	C-2	C-2	C-2
Limit /H (C-2 – G8)	G8	G8	G8	G8	G8	G8	G8	G8
Detune (-7 – +7)	0	-2	+2	-1	+1	-3	+1	-2
Note Shift (-24 – +24)	0	0	0	0	0	0	0	0
Volume (0-99)	99	99	99	99	99	99	99	99
Out Assign (off, I, II, I II)	I, II	I, II	I, II	I, II	I, II	I, II	I, II	I, II
LFO Select (off, 1, 2, vib)	1	1	1	1	1	1	1	1
Micro Tune (select)	off	off	off	off	off	off	off	off
Effect Select	Delay							

Voice Name
 1 Nylon Guit
 2 Nylon Guit
 3 Nylon Guit
 4 Nylon Guit
 5 Nylon Guit
 6 Nylon Guit
 7 Nylon Guit
 8 Nylon Guit

EFFECT 1	DELAY TIME	0.09
Delay	PITCH SHIFT	0
	FEEDBACK	0
	EFFECT LEVEL	73

Performance No. 2

Performance name	Hollo Flute							
Instrument	1	2	3	4	5	6	7	8
Assign Mode	Normal							
Max Notes (0-8)	4	4						
Voice No. (I01-D32)	B31	B12						
Receive Ch. (1-16, omni)	1	1						
Limit /L (C2 – G8)	C-2	C-2						
Limit /H (C2 – G8)	G8	G8						
Detune (-7 – +7)	-4	+4						
Note Shift (-24 – +24)	0	-12						
Volume (0-99)	67	99						
Out Assign (off, I, II, I II)	I	II						
LFO Select (off, 1, 2, vib)	1	2						
Micro Tune (select)								
Effect Select	Delay							

Voice Name
 1 PercFlute
 2 PanFlout
 3
 4
 5
 6
 7
 8

EFFECT 1	DELAY TIME	0.09
Delay	PITCH SHIFT	0
	FEEDBACK	0
	EFFECT LEVEL	73

Performance No. 3

Performance name	Bass/Sax							
Instrument	1	2	3	4	5	6	7	8
Assign Mode	Normal							
Max Notes (0-8)	6	2						
Voice No. (I01-D32)	B10	C14						
Receive Ch. (1-16, omni)	1	1						
Limit /L (C-2 – G8)	C#3	C-2						
Limit /H (C-2 – G8)	G8	C3						
Detune (-7 – +7)	0	0						
Note Shift (-24 – +24)	-24	+12						
Volume (0-99)	90	90						
Out Assign (off, I, II, I II)	I, II	I, II						
LFO Select (off, 1, 2 vib)	1	2						
Micro Tune (select)	off	off						
Effect Select	Delay							

Voice Name

- 1 Rasp Alto
- 2 Jaco Bass
- 3
- 4
- 5
- 6
- 7
- 8

EFFECT 1	DELAY TIME	0.09
Delay	PITCH SHIFT	0
	FEEDBACK	0
	EFFECT LEVEL	73

Performance No. 4

Performance name	Fanfare Brs							
Instrument	1	2	3	4	5	6	7	8
Assign Mode	Normal							
Max Notes (0-8)	4	4						
Voice No. (I01-D32)	B01	B06						
Receive Ch. (1-16, omni)	1	1						
Limit /L (C-2 – G8)	C-2	C-2						
Limit /H (C-2 – G8)	G8	G8						
Detune (-7 – +7)	-1	+2						
Note Shift (-24 – +24)	0	0						
Volume (0-99)	69	99						
Out Assign (off, I, II, I II)	I, II	I, II						
LFO Select (off, 1, 2, vib)	1	2						
Micro Tune (select)								
Effect Select	Chord							

Voice Name

- 1 Trumpet81Z
- 2 AtackBrass
- 3
- 4
- 5
- 6
- 7
- 8

EFFECT 3 Chord	C3	G2, C3, E2	F#3	A#2, C#3, D#3, F#3
	C#3	F2, C#3, G#2, A#2	G3	B2, D3, G3
	D3	G2, B2, D3	G#3	C3, G#3, D#3, F3
	D#3	G2, A#2, D#3	A3	C3, F3, A3
	E3	G2, C3, E3	A#3	D3, G3, A#3, F3
	F3	A2, C3, D3, F3	B3	D3, F3, B3, G3

Performance Data

Performance No. 5

Performance name	Chorus EP							
Instrument	1	2	3	4	5	6	7	8
Assign Mode	Normal							
Max Notes (0-8)	4	4						
Voice No. (I01-D32)	A13	A13						
Receive Ch. (1-16, omni)	1	1						
Limit /L (C-2 – G8)	C-2	C-2						
Limit /H (C-2 – G8)	G8	G8						
Detune (-7 +7)	+3	-3						
Note Shift (-24 – +24)	0	0						
Volume (0-99)	99	99						
Out Assign (off, I, II, I II)	I	II						
LFO Select (off, 1, 2, vib)	1	2						
Micro Tune (select)	off	off						
Effect Select	Pan							

Voice Name
 1 DynomiteEP
 2
 3
 4
 5
 6
 7
 8

EFFECT 2	Select	LFO
Pan	Direction	I→II
	Range	25

Performance No. 6

Performance name	Wind Band							
Instrument	1	2	3	4	5	6	7	8
Assign Mode	Alternate							
Max Notes (0-8)	1	1	1	1	1	1	1	1
Voice No. (I01-D32)	B11	B15	B14	B05	B04	B03	B01	B02
Receive Ch. (1-16, omni)	1	1	1	1	1	1	1	1
Limit /L (C-2 – G8)	C2	C2	C2	C2	C2	C2	C2	C2
Limit /H (C-2 – G8)	G8	G8	G8	G8	G8	G8	G8	G8
Detune (-7 – +7)	0	-2	-1	+1	3	-3	-1	+1
Note Shift (-24 – +24)	-12	0	-12	0	0	0	0	0
Volume (0-99)	94	92	95	99	92	99	84	99
Out Assign (off, I, II, I II)	I	II	I	II	I	II	I	II
LFO Select (off, 1, 2, vib)	1	2	vib	vib	vib	vib	vib	vib
Micro Tune (select)	off	off	off	off	off	off	off	off
Effect Select	Off							

Voice Name
 1 Flute
 2 Clarinet
 3 Oboe
 4 FrenchHorn
 5 ChorusBras
 6 FlugelHorn
 7 Trumpet81Z
 8 FullBrass

Performance No. 7

Performance name	Hi Strings							
Instrument	1	2	3	4	5	6	7	8
Assign Mode	Normal							
Max Notes (0-8)	4	4						
Voice No. (I01-D32)	B30	B30						
Receive Ch. (1-16, omni)	1	1						
Limit /L (C-2 – G8)	C-2	C-2						
Limit /H (C-2 – G8)	G8	G8						
Detune (-7 – +7)	-3	+3						
Note Shift (-24 – +24)								
Volume (0-99)	99	99						
Out Assign (off, I, II, I II)	I	II						
LFO Select (off, 1, 2, vib)	1	2						
Micro Tune (select)	off	off						
Effect Select	Off							

Voice Name

- 1 HiString 2
- 2 HiString 2
- 3
- 4
- 5
- 6
- 7
- 8

Performance No. 8

Performance name	Big Tim Lead							
Instrument	1	2	3	4	5	6	7	8
Assign Mode	Normal							
Max Notes (0-8)	1	1	1	1	1	1	1	1
Voice No. (I01-D32)	C22	C22	C22	C22	C25	C25	C25	C25
Receive Ch. (1-16, omni)	1	1	1	1	1	1	1	1
Limit /L (C-2 – G8)	C-2	C-2	C-2	C-2	C-2	C-2	C-2	C-2
Limit /H (C-2 – G8)	G8	G8	G8	G8	G8	G8	G8	G8
Detune (-7 – +7)	+4	-4	+2	-2	-5	+5	-6	+6
Note Shift (-24 – +24)	-12	0	0	0	-12	0	0	0
Volume (0-99)	77	82	82	82	77	82	82	82
Out Assign (off, I, II, I II)	I	II	I	II	II	I	II	I
LFO Select (off, 1, 2, vib)	1	1	1	1	1	1	1	1
Micro Tune (select)	off	off	off	off	off	off	off	off
Effect Select	Off							

Voice Name

- 1 Sync Lead
- 2 Sync Lead
- 3 Sync Lead
- 4 Sync Lead
- 5 Heavy Lead
- 6 Heavy Lead
- 7 Heavy Lead
- 8 Heavy Lead

Performance Data

Performance No. 9

Performance name	Pluck Delay							
Instrument	1	2	3	4	5	6	7	8
Assign Mode	Normal							
Max Notes (0-8)	4	4						
Voice No. (I01-D32)	B23	B24						
Receive Ch. (1-16, omni)	1	1						
Limit /L (C-2 – G8)	C-2	C-2						
Limit /H (C2 – G8)	G8	G8						
Detune (-7 – +7)	-2	+2						
Note Shift (-24 – +24)	+24	0						
Volume (0-9)	85	91						
Out Assign (off, I, II, I II)	I	II						
LFO Select (off, 1, 2, vib)	1	2						
Micro Tune (select)								
Effect Select	Delay							

Voice Name

- 1 Pizzicato
- 2 Harp
- 3
- 4
- 5
- 6
- 7
- 8

EFFECT1	DELAY TIME	0.09
Delay	PITCH SHIFT	0
	FEEDBACK	0
	EFFECT LEVEL	73

Performance No. 10

Performance name	Elec Choir							
Instrument	1	2	3	4	5	6	7	8
Assign Mode	Normal							
Max Notes (0-8)	2	3	3					
Voice No. (I01-D32)	D01	D03	D04					
Receive Ch. (1-16, omni)	1	1	1					
Limit /L (C-2 – G8)	C-2	C-2	C-2					
Limit /H (C-2 – G8)	G8	G8	G8					
Detune (-7 – +7)	0	-5	7					
Note Shift (-24 – +24)	0	0	0					
Volume (0-99)	99	50	91					
Out Assign (off, I, II, I II)	I II	I II	I II					
LFO Select (off, 1, 2, vib)	1	2	vib					
Micro Tune (select)	on	on	off					
Effect Select	Pan							

Voice Name

- 1 BaadBreath
- 2 KrstChoir
- 3 Voices
- 4
- 5
- 6
- 7
- 8

EFFECT 2	Select	LFO
Pan	Direction	I → II
	Range	25

Performance No. 11

Performance name	Bs → Gtr → Flt							
Instrument	1	2	3	4	5	6	7	8
Assign Mode	Normal							
Max Notes (0-8)	1	5	2					
Voice No. (I01-D32)	C14	C05	C24					
Receive Ch. (1-16, omni)	1	1	1					
Limit /L (C-2 – G8)	C-2	C#3	G4					
Limit /H (C-2 – G8)	C3	F#4	G8					
Detune (-7 – +7)	0	0	0					
Note Shift (-24 – +24)	+12	0	0					
Volume (0-99)	61	99	98					
Out Assign (off, I, II, I II)	I II	I	II					
LFO Select (off, 1, 2, vib)	1	2	vib					
Micro Tune (select)	off	off	off					
Effect Select	Off							

Voice Name
 1 Jaco Bass
 2 AllThatJaz
 3 Jazz Flute
 4
 5
 6
 7
 8

Performance No. 12

Performance name	Honky Grand							
Instrument	1	2	3	4	5	6	7	8
Assign Mode	Alternate							
Max Notes (0-8)	1	1	1	1	1	1	1	1
Voice No. (I01-D32)	A02	A02	A02	A02	A02	A02	A02	A02
Receive Ch. (1-16, omni)	1	1	1	1	1	1	1	1
Limit /L (C-2 – G8)	C-2	C-2	C-2	C-2	C-2	C-2	C-2	C-2
Limit /H (C-2 – G8)	G8	G8	G8	G8	G8	G8	G8	G8
Detune (-7 – +7)	0	+4	-4	+7	-7	+2	-2	+5
Note Shift (-24 – +24)	+12	+12	+12	+12	+12	+12	+12	+12
Volume (0-99)	90	90	90	90	90	90	90	90
Out Assign (off, I, II, I II)	I II	I II	I II	I II	I II	I II	I II	I II
LFO Select (off, 1, 2, vib)	1	1	1	1	1	1	1	1
Micro Tune (select)	off	off	off	off	off	off	off	off
Effect Select	Pan							

Voice Name
 1 Uprt Piano
 2
 3
 4
 5
 6
 7
 8

EFFECT2 Pan	Select	LFO
	Direction	I → II
	Range	25

Performance Data

Performance No. 13

Performance name	Syn Strings							
Instrument	1	2	3	4	5	6	7	8
Assign Mode	Normal							
Max Notes (0-8)	4	4						
Voice No. (I01-D32)	B26	B26						
Receive Ch. (1-16, omni)	1	1						
Limit /L (C-2 – G8)	C-2	C-2						
Limit /H (C-2 – G8)	G8	G8						
Detune (-7 – +7)	-4	+4						
Note Shift (-24 – +24)	0	0						
Volume (0-99)	92	92						
Out Assign (off, I, II, I II)	I	II						
LFO Select (off, 1, 2, vib)	1	2						
Micro Tune (select)	off	off						
Effect Select	Off							

Voice Name
 1 SynString
 2 SynString
 3
 4
 5
 6
 7
 8

Performance No. 14

Performance name	Ice Cream							
Instrument	1	2	3	4	5	6	7	8
Assign Mode	Normal							
Max Notes (0-8)	4	4						
Voice No. (I01-D32)	A30	A31						
Receive Ch. (1-16, omni)	1	1						
Limit /L (C-2 – G8)	C-2	C-2						
Limit /H (C-2 – G8)	G8	G8						
Detune (-7 – +7)	-3	+3						
Note Shift (-24 – +24)	0	0						
Volume (0-99)	90	90						
Out Assign (off, I, II, I II)	I	II						
LFO Select (off, 1, 2, vib)	1	2						
Micro Tune (select)	off	off						
Effect Select	Pan							

Voice Name
 1 Celeste
 2 BriteCelst
 3
 4
 5
 6
 7
 8

EFFECT 2	Select	LFO
Pan	Direction	I → II
	Range	25

Performance No. 15

Performance name	Thin Clav								Voice Name
Instrument	1	2	3	4	5	6	7	8	1 Thin Clav
Assign Mode	Normal								2
Max Notes (0-8)	4	4							3
Voice No. (I01-D32)	A25	A25							4
Receive Ch. (1-16, omni)	1	1							5
Limit /L (C-2 – G8)	C-2	C-2							6
Limit /H (C-2 – G8)	G8	G8							7
Detune (-7 – +7)	-3	+2							8
Note Shift (-24 – +24)	0	0							
Volume (0-99)	88	88							
Out Assign (off, I, II, I II)	I	II							
LFO Select (off, 1, 2, vib)	1	2							
Micro Tune (select)	off	off							
Effect Select	Off								

Performance No. 16

Performance name	Amazon Flt								Voice Name
Instrument	1	2	3	4	5	6	7	8	1 Flute
Assign Mode	Normal								2 BreathOrgn
Max Notes (0-8)	4	4							3
Voice No. (I01-D32)	B11	B32							4
Receive Ch. (1-16, omni)	1	1							5
Limit /L (C-2 – G8)	C-2	C-2							6
Limit /H (C-2 – G8)	G8	G8							7
Detune (-7 – +7)	-2	+3							8
Note Shift (-24 – +24)	-12	0							
Volume (0-99)	99	99							
Out Assign (off, I, II, I II)	I, II	I, II							
LFO Select (off, 1, 2, vib)	1	2							
Micro Tune (select)	on	on							
Effect Select	Delay								

EFFECT 1	DELAY TIME	0.09
Delay	PITCH SHIFT	0
	FEEDBACK	0
	EFFECT LEVEL	73

Performance No. 17

Performance name	Rubber Band								Voice Name
Instrument	1	2	3	4	5	6	7	8	1 PlasticHit
Assign Mode	Normal								2 DynamiteEP
Max Notes (0-8)	4	4							3
Voice No. (I01-D32)	C31	A13							4
Receive Ch. (1-16, omni)	1	1							5
Limit /L (C-2 – G8)	C-2	C-2							6
Limit /H (C-2 – G8)	G8	G8							7
Detune (-7 – +7)	-2	+2							8
Note Shift (-24 – +24)	0	0							
Volume (0-99)	91	99							
Out Assign (off, I, II, I II)	I, II	I, II							
LFO Select (off, 1, 2, vib)	1	2							
Micro Tune (select)	off	off							
Effect Select	Delay								

EFFECT 1	DELAY TIME	0.09
Delay	PITCH SHIFT	0
	FEEDBACK	0
	EFFECTLEVEL	73

Performance No. 18

Performance name	Great Strg								Voice Name
Instrument	1	2	3	4	5	6	7	8	1 BowCello
Assign Mode	Alternate								2 BoxCello
Max Notes (0-8)	1	1	1	1	1	1	1	1	3 DoubleBass
Voice No. (I01-D32)	B18	B19	B17	B18	B19	B17	B18	B19	4 BowCello
Receive Ch. (1-16, omni)	1	1	1	1	1	1	1	1	5 BoxCello
Limit /L (C-2 – G8)	C-2	C-2	C-2	C-2	C-2	C-2	C-2	C-2	6 DoubleBass
Limit /H (C-2 – G8)	G8	G8	G8	G8	G8	G8	G8	G8	7 BowCello
Detune (-7 – +7)	0	-2	+2	-1	+1	-3	+3	-2	8 BoxCello
Note Shift (-24 – +24)	0	0	0	0	0	0	0	0	
Volume (0-99)	97	96	90	94	93	90	91	89	
Out Assign (off, I, II, I II)	I, II	I, II	I, II	I, II	I, II	I, II	I, II	I, II	
LFO Select (off, 1, 2, vib)	1	2	vib	1	2	vib	1	2	
Micro Tune (select)	off	off	off	off	off	off	off	off	
Effect Select	Off								

Performance No. 19

Performance name	Vocal Hit							
Instrument	1	2	3	4	5	6	7	8
Assign Mode	Normal							
Max Notes (0-8)								
Voice No. (I01-D32)	D02	D02	D02	D02				
Receive Ch. (1-16, omni)	1	1	1	1				
Limit /L (C-2 – G8)	C-2	C-2	C-2	C-2				
Limit /H (C-2 – G8)	G8	G8	G8	G8				
Detune (-7 – +7)	+3	-3	+5	-5				
Note Shift (-24 – +24)	0	0	+12	0				
Volume (0-99)	99	99	99	99				
Out Assign (off, I, II, I II)	I, II	I	II	I, II				
LFO Select (off, 1, 2, vib)	1	1	1	1				
Micro Tune (select)	off	off	off	off				
Effect Select	Delay							

Voice Name
 1 Vocal Nuts
 2 Vocal Nuts
 3 Vocal Nuts
 4 Vocal Nuts
 5
 6
 7
 8

EFFECT 1 Delay	DELAY TIME	0.09
	PITCH SHIFT	0
	FEEDBACK	0
	EFFECT LEVEL	73

Performance No. 20

Performance name	Slapn Dyno							
Instrument	1	2	3	4	5	6	7	8
Assign Mode	Normal							
Max Notes (0-8)	1	1	6					
Voice No. (I01-D32)	C09	C09	A13					
Receive Ch. (1-16, omni)	1	1	1					
Limit /L (C-2 – G8)	C-2	C-2	C#3					
Limit /H (C-2 – G8)	C3	C3	G8					
Detune (-7 – +7)	+3	-3	0					
Note Shift (-24 – +24)	+12	+12	0					
Volume (0-99)	99	99	99					
Out Assign (off, I, II, I II)	I	II	I, II					
LFO Select (off, 1, 2, vib)	1	1	vib					
Micro Tune (select)	off	off	off					
Effect Select	Off							

Voice Name
 1 ElecBass 1
 2 ElecBass 1
 3 DynamiteEP
 4
 5
 6
 7
 8

Performance Data

Performance No. 21

Performance name	Voice & Guitar							
Instrument	1	2	3	4	5	6	7	8
Assign Mode	Normal							
Max Notes (0-8)	4	4						
Voice No. (I01-D32)	C02	D01						
Receive Ch. (1-16, omni)	1	1						
Limit /L (C-2 – G8)	C-2	C-2						
Limit /H (C-2 – G8)	G8	G8						
Detune (-7 – +7)	+5	0						
Note Shift (-24 – +24)	0	-12						
Volume (0-99)	82	95						
Out Assign (off, I, II, I II)	I	II						
LFO Select (off, 1, 2, vib)	1	2						
Micro Tune (select)	off	off						
Effect Select	Off							

Voice Name
 1 Guitar #1
 2 BaadBreath
 3
 4
 5
 6
 7
 8

Performance No. 22

Performance name	Chorus Bras							
Instrument	1	2	3	4	5	6	7	8
Assign Mode	Normal							
Max Notes (0-8)	4	4						
Voice No. (I01-D32)	B04	B04						
Receive Ch. (1-16, omni)	1	1						
Limit /L (C-2 – G8)	C-2	C-2						
Limit /H (C-2 – G8)	G8	G8						
Detune (-7 – +7)	-4	+4						
Note Shift (-24 – +24)	0	0						
Volume (0-99)	95	95						
Out Assign (off, I, II, I II)	I	II						
LFO Select (off, 1, 2, vib)	1	2						
Micro Tune (select)	off	off						
Effect Select	Off							

Voice Name
 1 ChorusBras
 2 ChorusBras
 3
 4
 5
 6
 7
 8

Performance No. 23

Performance name	Koto Choir							
Instrument	1	2	3	4	5	6	7	8
Assign Mode	Normal							
Max Notes (0-8)	4	4						
Voice No. (I01-D32)	D08	B27						
Receive Ch. (1-16, omni)	1	1						
Limit /L (C-2 – G8)	C-2	C-2						
Limit /H (C-2 – G8)	G8	G8						
Detune (-7 – +7)	0	0						
Note Shift (-24 – +24)	0	0						
Volume (0-99)	99	99						
Out Assign (off, I, II, I II)	I	II						
LFO Select (off, 1, 2, vib)	1	2						
Micro Tune (select)	off	off						
Effect Select	Delay							

Voice Name

1 Fuzzy Koto

2 Voices

3

4

5

6

7

8

EFFECT 1	DELAY TIME	0.09
Delay	PITCH SHIFT	0
	FEEDBACK	0
	EFFECT LEVEL	73

Performance No. 24

Performance name	Percolator							
Instrument	1	2	3	4	5	6	7	8
Assign Mode	Normal							
Max Notes (0-8)	2	2	2	2				
Voice No. (I01-D32)	D26	D27	D30	D24				
Receive Ch. (1-16, omni)	1	1	1	1				
Limit /L (C-2 – G8)	C-2	C-2	C4	B5				
Limit /H (C-2 – G8)	B1	B3	A#5	C6				
Detune (-7 – +7)	0	0	0	0				
Note Shift (-24 – +24)	+12	0	+5	-24				
Volume (0-99)	79	97	99	97				
Out Assign (off, I, II, I II)	I	II	II	I				
LFO Select (off, 1, 2, vib)	1	2	vib	vib				
Micro Tune (select)	off	off	off	off				
Effect Select	Off							

Voice Name

1 Tube Bells

2 Noise Shot

3 Hand Drum

4 FM Hi-Hats

5

6

7

8

PERFORMANCE MEMO CHART

Performance name								
Instrument	1	2	3	4	5	6	7	8
Assign Mode	Normal / Alternate							
Max Notes (0-8)								
Voice No. (I01-D32)								
Receive Ch. (1-16, omni)								
Limit /L (C-2 – G8)								
Limit /H (C-2 – G8)								
Detune (-7 – +7)								
Note Shift (-24 – +24)								
Volume (0-99)								
Out Assign (off, I, II, I II)								
LFO Select (off, 1, 2, vib)								
Micro Tune (select)	off/on	off/on	off/on	off/on	off/on	off/on	off/on	off/on
Effect Select	off / Delay / Pan / Chord							

Performance name								
Instrument	1	2	3	4	5	6	7	8
Assign Mode	Normal / Alternate							
Max Notes (0-8)								
Voice No. (I01-D32)								
Receive Ch. (1-16, omni)								
Limit /L (C-2 – G8)								
Limit /H (C-2 – G8)								
Detune (-7 – +7)								
Note Shift (-24 – +24)								
Volume (0-99)								
Out Assign (off, I, II, I II)								
LFO Select (off, 1, 2, vib)								
Micro Tune (select)	off/on	off/on	off/on	off/on	off/on	off/on	off/on	off/on
Effect Select	off / Delay / Pan / Chord							

VOICE DATA LIST

VOICE NO./ NAME _____

ALGORITHM				
FEEDBACK				
FREQUENCY				
OSC. WAVE				
DETUNE				
OUT LEVEL				

EG				
AR				
D1R				
D1L				
D2R				
RR				
EG SHIFT	OFF			

SCALING				
RATE				
LEVEL				

SENSITIVITY				
PITCH				
AMPLITUDE (0-3) (ON/OFF)				
EG BIAS				
KEY VELOCITY				

LFO	
WAVE	
SPEED	
DELAY	
P MOD DEPTH	
A MOD DEPTH	
SYNC	

FUNCTION	
MODE	
P BEND RANGE	
PORTAMENTO	
PORTAMENTO TIME	
FC VOLUME	
FC PITCH	
FC AMPLITUDE	
MW PITCH	
MW AMPLITUDE	
BC PITCH	
BC AMPLITUDE	
PC PITCH BIAS	
BC EG BIAS	
MIDDLE C	
REVERB RATE	

MIDI RECEPTION/TRANSMISSION

The TX81Z responds to MIDI messages as shown in the diagram on p.66. For System Exclusive messages see p.67. BCH indicates Basic Rcv. Ch. (p.25) and RCH indicates the receive channel for an individual instrument (p.39). G1-G16 indicates the Global Channel for Controller (p.25) or Pitch Bend (p.26).

*In the case of Control Change "Pan" (Bn.0A.xx), data values of 0 ~ 42 = output I, 43 ~ 85 = output I + II and 86 ~ 127 = output II.

*System Common messages F1h-F7h and System Realtime messages F8h-FDh and FFh are ignored.

*Once an Active Sensing message FEh is received, the TX81Z will expect a continuing stream of MIDI messages. If no messages come for a period of about 300 msec, it clears the MIDI input buffer and turns off any notes that are currently sounding.

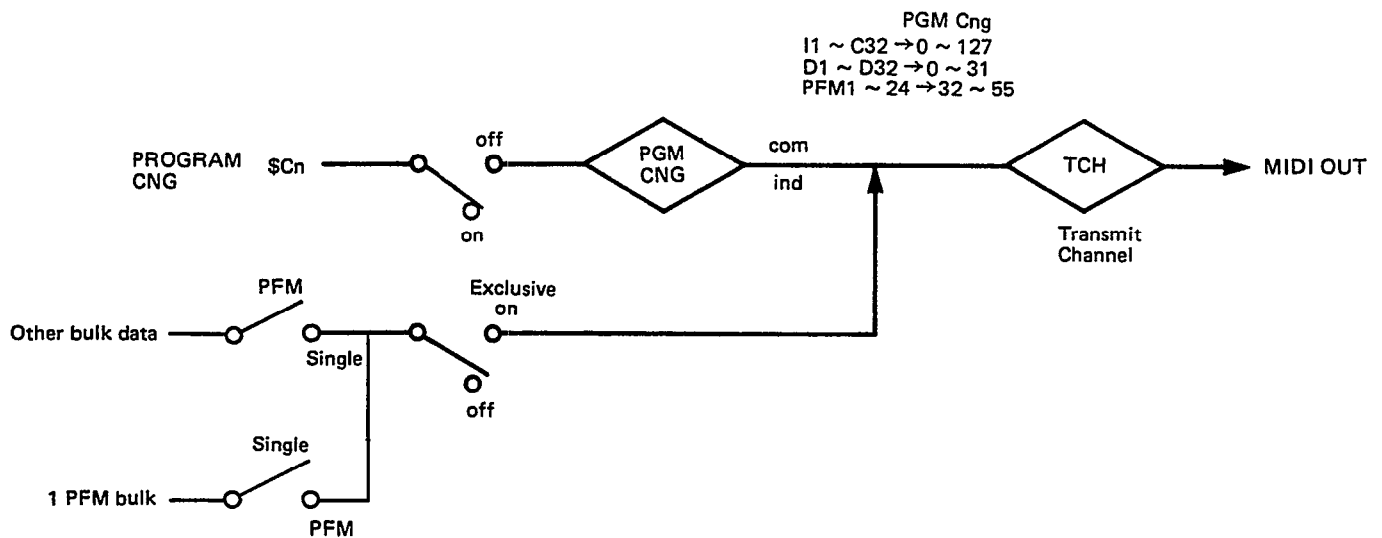

*In PLAY mode when a voice or performance is selected using the front panel keys, the TX81Z will send a program change message. I01-C32 (0-127), D01-D32 (0-31), PF01-PF24 (32-55).

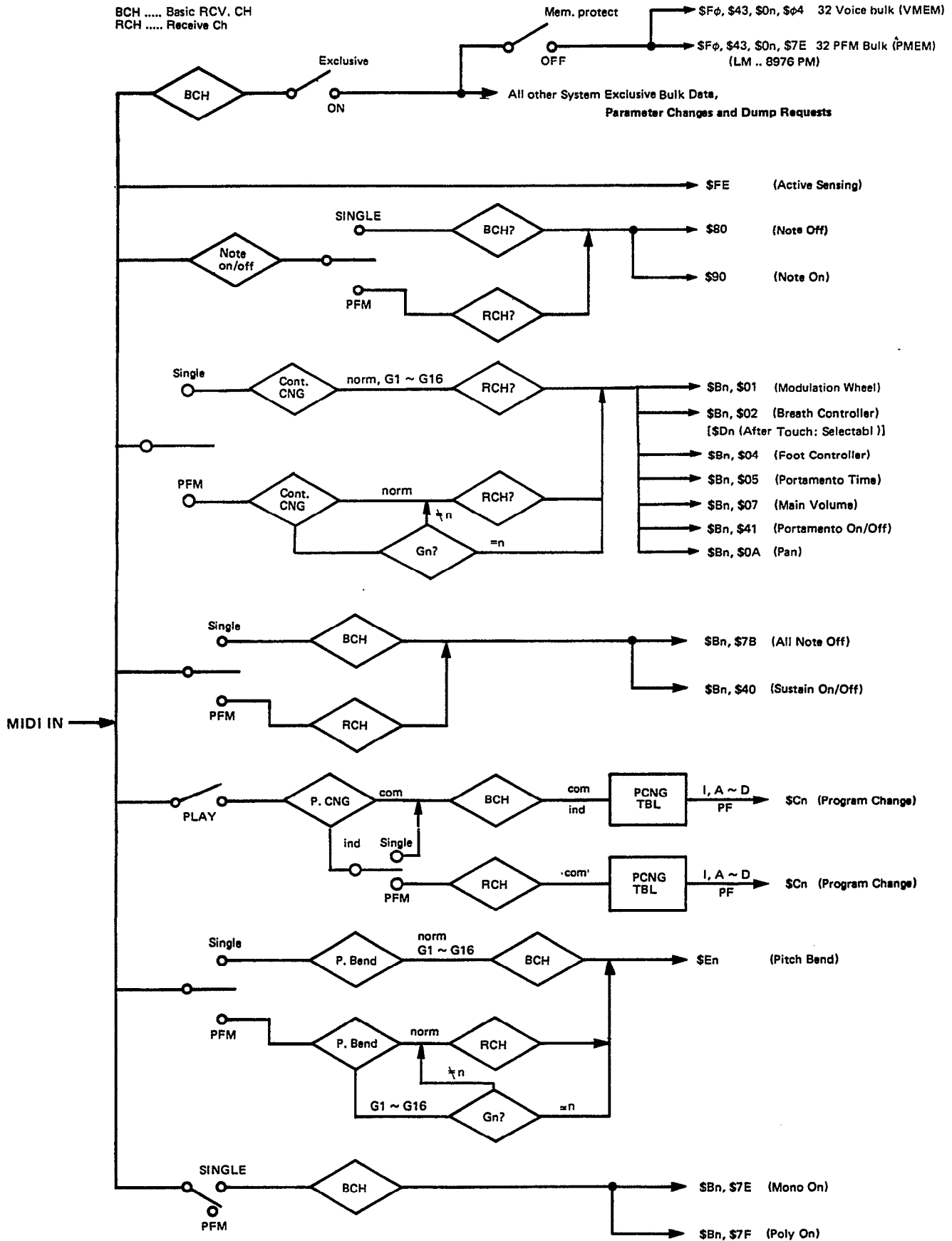

SYSTEM EXCLUSIVE DATA FORMAT

Reading this section will not necessarily help you use the TX81Z. This data is provided to comply with the MIDI Specification, and will be helpful to those who write computer programs to process TX81Z data. The TX81Z has three types of System Exclusive message; Parameter Change messages, Bulk Data messages and Dump Request messages.

PARAMETER CHANGE MESSAGES

These messages change the value of a parameter in TX81Z memory, There are 8 subgroups of Parameter Changes; VCED, ACED, PCED, Remote Switch, Micro Tuning, Program Change, Effect data and System data.

VCED, ACED, PCED and Remote Switch parameter change messages have the following format.

```

11110000 F0h Exclusive
01000011 43h I.D. number (Yamaha)
0001nnnn 1nh Basic receive channel
0ggggghh ggggg = Group number, hh = Subgroup number
0ppppppp ppppppp = Parameter number
0ddddddd ddddddd = Data
11110111 F7h End Of Exclusive

```

*VCED (Voice parameters compatible with DX21/27/100)

ggggg = 00100 (4), hh = 10 (2)

See p.71 for parameter numbers and data.

*ACED (Additional voice parameters for TX81Z)

ggggg = 00100 (4), hh = 11 (3)

See p.73 for parameter numbers and data.

*PCED (Performance parameters)

ggggg = 00100 (4), hh = 11 (3)

See p.74 for parameter numbers and data.

*Remote Switch (The same effect as pressing a switch on the TX81Z front panel, ie. "remote control".)

ggggg = 00100 (4), hh = 11 (3), ddddddd = 0 (off), 7F (on)

See p.75 for switch numbers.

System Parameter Change (basic receive channel settings, etc.) and Effect Parameter Change (data for delay, pan and chord) messages have the following format.

```

11110000 F0h Exclusive
01000011 43h I.D. number (Yamaha)
0001nnnn 1nh Basic receive channel
0ggggghh ggggg = 00100 (4), hh = 00 (0)
0ppppppp ppppppp = 1111011 (123) = System Parameter
                    1111100 (124) = Effect Parameter
0kkkkkkk kkkkkkk = Parameter number

```

```

Oddddddd  ddddddd = data
11110111  F7h  End of Exclusive

```

Micro Tune parameter change messages have the following format.

```

11110000  F0h  Exclusive
d1000011  43h  I.D. number (Yamaha)
0001nnnn  1nh  Basic receive channel
Oggggggh  ggggg = 00100 (4), hh = 00
Oppppppp  pppppp = 1111101 (125) OCT
                    1111110 (126) FULL
Okkkkkkk  kkkkkkk =key number
Ohhhhhhh  hhhhhhh =note C #-1 to C7 (13-108)
Olllllll  lllllll = data fine tuning 0 to +31, -31 to -1 (0-32,33-63)
11110111  F7h End Of Exclusive

```

Program Change Table parameter change messages have the following format. The data is 0-184d, indicating the TX81Z memory to be selected in response to the incoming program change number. 0-31 (I1-I32), 32-63 (A1-A32), 64-95 (B1-B32), 96-127 (C1-C32), 128-160 (D1-D32), 161-184 (PF1-PF24)

```

11110000  F0h  Exclusive
01000011  43h  I.D. number (Yamaha)
0001nnnn  1nh  Basic receive channel
Oggggggh  ggggg = 00100 (4), hh = 00
Oppppppp  pppppp = 1111111 (127)
Okkkkkkk  kkkkkkk = program change number
Ohhhhhhh  hhhhhhh = data (high)
Olllllll  lllllll = data (low)
11110111  F7h End Of Exclusive

```

BULK DATA MESSAGES

The TX81Z receives and transmits 10 types of bulk data message. Each has the format F0 (System Exclusive), 43 (Yamaha ID number), 0n (bulk data on channel n), data size (high), data size (low), data, checksum (twos complement of the lower 7 bits of the sum of all databytes), F7 (EOX). Some bulk data messages have a 10-character ASCII header. These characters are considered to be part of the data.

*Voice (SCED)

Additional voice parameters for the TX81Z. f = 126 (7Eh) "LM .. 8986-AE", data size = 23 + 10 = 33 (0021h)
F0. 43. 0n. 7E. 00. 21. "LM .. 8976AE". (ACED data). checksum. F7

*1 Voice (VCED)

Voice parameters for the TX81Z. f = 4, data size = 93 (005dh), total size = 93 + 8 = 101 (5Dh)
F0. 43. 0n. 03.00.5D. (VCED data). checksum. F7

Note

These two bulk data messages are transmitted when a voice is selected while in PLAY SINGLE mode, or when you "Init Voice" or "Recall Edit". If ACED is received alone, the VCED edit buffer will be unaffected, If VCED is received alone, the ACED edit buffer will be initialized.

*32 Voice (VMEM)

This message includes both ACED and VCED parameters for 32 voices.
f = 4, data size = 128 x 32 = 4096 (1000h), total size = 4096 + 8 = 4104
FO. 43. 0n. 04. 10.00. (VMEM data). checksum. F7

*1 Performance (PCED)

The contents of the performance edit buffer.
f = 126 (7Eh) "LM .. 8976PE", data size = 120 (0078h), total size = 120 + 8 = 128
FO. 43. 0n. 7E. 00. 78. "LM .. 8976PE". (data). checksum. F7

*32 Performance (PMEM)

Data for 24 internal performance memories + 8 initial performances.
f = 126 "LM .. 8976PM". data size = 10 + (76 x 32) = 2442 (098Ah)
total size = 2442 + 8 = 2450
FO. 43. 0n. 7E. 13. 0A. "LM .. 8976PM", (data). checksum. F7

*System (SYS)

TX81Z system data (basic receive channel, etc.)
f = 126 "LM .. 8976S0", data size = 10 + 27 = 37, total size = 37 + 8 = 45
FO. 43. 0n. 7E. 00. 25. "LM .. 8976S0", (data). checksum. F7

*Program Change Table (SYS)

Selected memory numbers I1-PF24 for each incoming program change.
f = 126 "LM .. 8976S1", data size = 10 + 128 x 2 = 266 (010Ah), total size = 266 + 8 = 274
FO. 43. 0n. 7E. 02. 0A. "LM .. 8976S1", (data), checksum. F7

*Effect Data (SYS)

Data for the three effects (delay, pan, chord)
f = 126 "LM .. 8976S2", data size = 10 + 55 = 65 (0041h), total size = 65 + 8 = 73
FO. 43. 0n. 7E. 00. 41. "LM .. 8976S2", (data) checksum. F7

*Micro Tune Octave

Contents of the user octave micro tune memory.
f = 126 "LM .. MCRTE0", data size = 24 + 10 = 34 (0022h), total size = 34 + 8 = 42
FO. 43. 0n. 7E. 00. 22. "LM .. MCRTE0", (data). checksum. F7

*Micro Tune Full Kbd

Contents of the user full keyboard micro tune memory.
f = 126 "LM .. MCRTE1", data size = 256 + 10 = 266 (010Ah), total size = 274
FO. 43. 0n. 7E. 00. 22. "LM .. MCRTE1", (data). checksum. F7

**DUMP REQUEST
MESSAGES**

When the TX81Z receives one of these messages with a channel number “n” that matches its Basic Receive channel, it will transmit the requested data as described above in Bulk Data.

VCED	F0. 43. 2n. 03. F7
VMEM	F0. 43. 2n. 04. F7
ACED + VCED	F0. 43. 2n. 7E. “LM .. 8976AE”. F7
PCED	F0. 43. 2n. 7E. “LM .. 8976PE”. F7
PMEM	F0. 43. 2n. 7E. “LM .. 8976PM”. F7
System Setup	F0. 43. 2n. 7E. “LM .. 8976Sx”. F7 (X = 0, 1, 2)
Micro Tune	F0. 43. 2n. 7E. “LM .. MCRTE _x ”. F7 (X = 0, 1)

Voice Edit Parameters (VCED)

Parameter number	Parameter	LCD	Data
0	Attack Rate	AR	0-31
1	Decay 1 Rate	D1R	0-31
2	Decay 2 Rate	D2R	0-31
3	Release Rate	RR	1-15
4	Decay 1 Level	D1L	0-15
5	Level Scaling	LS	0-99
6	Rate Scaling	RS	0-3 OP. 4
7	EG Bias Sensitivity	EBS	0-7
8	Amplitude Modulation Enable	AME	0-1
9	Key Velocity Sensitivity	KVS	0-7
10	Operator Output Level	OUT	0-99
11	Frequency	CRS	0-63
12	Detune	DET	0-6 (Center = 3)
13 			OP. 3
26 			OP. 2
39 			OP. 1
52	Algorithm	ALG	0-7
53	Feedback	Feedback	0-7
54	LFO Speed	Speed	0-99
55	LFO Delay	Delay	0-99
56	Pitch Modulation Depth	P Mod Depth	0-99
57	Amplitude Modulation Depth	A Mod Depth	0-99
58	LFO Sync	Sync	0-1
59	LFO Wave	Wave	0-3
60	Pitch Modulation Sensitivity	P Mod Sens	0-7
61	Amplitude Modulation Sensitivity	AMS	0-3
62	Transpose	Middle C =	0-48 (Center = 24)
63	Poly/Mono	Poly Mode	0-1
64	Pitch Bend Range	P Bend Range	0-12
65	Portamento Mode	Full Time Porta	0-1
66	Portamento Time	Porta Time	0-99
67	Foot Control Volume	FC Volume	0-99
68	Sustain	—	0-1
69	Portamento	—	0-1
70	Chorus	—	0-1 (Set 0)
71	Modulation Wheel Pitch	MW Pitch	0-99
72	Modulation Wheel Amplitude	MW Amplitude	0-99
73	Breath Control Pitch	BC Pitch	0-99
74	Breath Control Amplitude	BC Amplitude	0-99

Parameter number	Parameter	LCD	Data
75	Breath Control Pitch Bias	BC Pitch Bias	0-99 (Center = 50)
76	Breath Control EG Bias	BC EG Bias	0-99
77	Voice name char 1	—	32-127
78	Voice name char 2	—	32-127
79	Voice name char 3	—	32-127
80	Voice name char 4	—	32-127
81	Voice name char 5	—	32-127
82	Voice name char 6	—	32-127
83	Voice name char 7	—	32-127
84	Voice name char 8	—	32-127
85	Voice name char 9	—	32-127
86	Voice name char 10	—	32-127
(Parameters 87-92 not used in the TX81Z.)			
93	Operator 4-1 On/Off (bits 0-3)		0-15 (OP. on = 1)

Voice Edit Additional Parameters (ACED)

Parameter number	Parameter	LCD	Data
0	Fixed Frequency	FIX	0-1
1	Fixed Frequency Range	Fix Range	1-7 0(250Hz) 7(32kHz)
2	Frequency Range Fine	FIN (RATIO)	0-15 OP. 4
3	Operator Waveform	OSW	0-7
4	EG Shift	SHFT	0-3 0(96dB), 1(48dB), 2(24dB), 3(12dB)
5			OP. 3
10			OP. 2
15			OP. 1
20	Reverb Rate	Reverb Rate	0-7 0(off), 7(fast)
21	Foot Controller Pitch	FC Pitch	0-99
22	Foot Controller Amplitude	FC Amplitude	0-99

Performance Edit Parameters (PCED)

Parameter number	Parameter	LCD	Data
0	Maximum Notes	MAX NOTES	0-8 INST 1
1	Voice Number MSB	—	0-1
2	Voice Number	I01-D32	0-127 } 0-159
3	Receive Channel	RECEIVE CH	0-16 omni = 16
4	Low Note Limit	LIMIT/L	0-127 0(C-2)-127(G8)
5	High Note Limit	LIMIT/H	0-127 0(C-2)-127(G8)
6	Instrument Detune	INST DETUNE	0-14 center = 7
7	Note Shift	NOTE SHIFT	0-48 center = 24
8	Volume	VOL	0-99
9	Output Assign	OUT ASSIGN	0-3 0(off), 1(I), 2(II), 3(I II)
10	LFO Select	LFO SELECT	0-3 0(off), 1 (inst1), 2(inst2), 3(vib)
11	Micro Tune Enable	off/on	0-1
12 			INST 2
24 			INST 3
36 ~			INST 4
48 			INST 5
60 			INST 6
72 			INST 7
84 			INST 8
96	Micro Tune Table	MICTUN	0-12
97	Assign Mode	Assign Mode	0-1 0(norm), 1 (altr)
98	Effect Select	Effect Sel	0-3
99	Key (for Micro Tune)	—	0-11 (C-B)
100	Performance Name Character 1	—	32-127 (ASCII)
101	Performance Name Character 2	—	32-127 (ASCII)
—			
109	Performance Name Character 10	—	32-127 (ASCII)

Remote Switch Parameters

Parameter number	Parameter	Data
64	POWER ON (reset)	0 (switch off), 127 (switch on)
65	STORE	
66	UTILITY	
67	EDIT	
68	PLAY	
69	PARAMETER -1	
70	PARAMETER +1	
71	DATA ENTRY -1	
72	DATA ENTRY +1	
73	MASTER VOLUME -1	
74	MASTER VOLUME +1	
75	CURSOR	

Voice Bulk Data Format (VMEM)

address	b7	b6	b5	b4	b3	b2	b1	b0	data	comment
0	0	0	0	_____	_____	AR	_____	_____	0-31	
1	0	0	0	_____	_____	D1R	_____	_____	0-31	
2	0	0	0	_____	_____	D2R	_____	_____	0-31	
3	0	0	0	0	_____	RR	_____	_____	0-15	
4	0	0	0	0	_____	D1L	_____	_____	0-15	OP.4
5	0	_____	_____	_____	LS	_____	_____	_____	0-99	
6	0	AME	_____	EBS	_____	_____	KVS	_____	0-1, 0-7, 0-7	
7	0	_____	_____	_____	OUT	_____	_____	_____	0-99	
8	0	0	_____	_____	F	_____	_____	_____	0-63	
9	0	0	0	RS	_____	_____	DBT	_____	0-3, 0-6	
10 ~ ~										OP.2
20 ~ ~										OP.3
30 ~ ~										OP.1
40	0	SY	_____	FBL	_____	_____	ALG	_____	0-1, 0-7, 0-7	
41	0	_____	_____	_____	LFS	_____	_____	_____	0-99	
42	0	_____	_____	_____	LFD	_____	_____	_____	0-99	
43	0	_____	_____	_____	PMD	_____	_____	_____	0-99	
44	0	_____	_____	_____	AMD	_____	_____	_____	0-99	
45	0	_____	PMS	_____	AMS	_____	LFW	_____	0-7, 0-3, 0-3	
46	0	0	_____	_____	TRPS	_____	_____	_____	0-48	
47	0	0	0	0	_____	PBR	_____	_____	0-12	
48	0	0	0	CH	MO	SU	PO	PM	0-1, 0-1, 0-1, 0-1, 0-1	
49	0	_____	_____	_____	PORT	_____	_____	_____	0-99	
50	0	_____	_____	_____	FC VOL	_____	_____	_____	0-99	
51	0	_____	_____	_____	MW PITCH	_____	_____	_____	0-99	
52	0	_____	_____	_____	MW AMPLI	_____	_____	_____	0-99	
53	0	_____	_____	_____	BC PITCH	_____	_____	_____	0-99	
54	0	_____	_____	_____	BC AMPLI	_____	_____	_____	0-99	
55	0	_____	_____	_____	BC P BIAS	_____	_____	_____	0-99	
56	0	_____	_____	_____	BC E BIAS	_____	_____	_____	0-99	
57	0	_____	_____	_____	VOICE NAME 1	_____	_____	_____	32-127 (ASCII)	
58	0	_____	_____	_____	VOICE NAME 2	_____	_____	_____		
59	0	_____	_____	_____	VOICE NAME 3	_____	_____	_____		
60	0	_____	_____	_____	VOICE NAME 4	_____	_____	_____		
61	0	_____	_____	_____	VOICE NAME 5	_____	_____	_____		
62	0	_____	_____	_____	VOICE NAME 6	_____	_____	_____		
63	0	_____	_____	_____	VOICE NAME 7	_____	_____	_____		
64	0	_____	_____	_____	VOICE NAME 8	_____	_____	_____		
65	0	_____	_____	_____	VOICE NAME 9	_____	_____	_____		
66	0	_____	_____	_____	VOICE NAME 10	_____	_____	_____	32-127 (ASCII)	
67	0	_____	_____	_____	PR1	_____	_____	_____	0-99 PEG (DX21 only)	
68	0	_____	_____	_____	PR2	_____	_____	_____	0-99 Set 99	
69	0	_____	_____	_____	PR3	_____	_____	_____	0-99	
70	0	_____	_____	_____	PL1	_____	_____	_____	0-99 Set 50	
71	0	_____	_____	_____	PL2	_____	_____	_____	0-99	
72	0	_____	_____	_____	PL3	_____	_____	_____	0-99	

Additional Voice Bulk Data Format

address	b7	b6	b5	b4	b3	b2	b1	b0	data	comment	
0 . .	same as OPM VMEM										
67 .	PEG PR1 (not used)		Set 99								
72 .	PEG PL3		Set 50								
73 74	0 0	0 _____	EGSFT — OPW —	FIX _____	_____	FIXRG — FINE _____				OP . 4	
75 .										OP . 2	
77 .										OP . 3	
79 .										OP . 1	
81	0	0	0	0	0	_____	REV	_____			
82 83	0 0	_____			FC PITCH		_____				
		_____			FC AMPLI		_____				

Effect Bulk Data Format

address	b7	b6	b5	b4	b3	b2	b1	b0	data	comment		
0	0	_____			EF1T		_____			0-127	effect 1 time 0.01s ~ 1.28s	
1	0	0	_____			EF1P		_____			0-48	effect 1 pitch center = 24
2	0	0	0	0	0	_____		EF1F	_____	0-7	effect 1 feedback	
3	0	_____			EF1L		_____			0-99	effect 1 level	
4	0	0	0	0	0	0	0	EF2D	_____	0-1	effect 2 direction 0 (I → II), 1 (II → I)	
5	0	0	0	0	0	0	0	EF2S	_____	0-3	effect 2 select 0 (LFO), 1 (velocity) 2 (note)	
6	0	_____			EF2R		_____			0-99	effect 2 range	
7	0	0	_____			CHORD		_____			0-49	effect 3 chord note center = 25, not used = 49
8 9 10										KEY C3		
11 12 13 14										KEY C3#		
. .												
51 52 53 54										KEY B3		

Performance Bulk Data Format (PMEM)

address	b7	b6	b5	b4	b3	b2	b1	b0	data	comment
0	0	OUT ASGN	MSB	_____	NUM of NOTE	—				INST1
1	0	_____	_____	_____	VOICE NO	_____				
2	0	LFOS	_____	_____	RCV CII	_____				
3	0	_____	_____	_____	LIMIT/L	_____				
4	0	_____	_____	_____	LIMIT/H	_____				
5	0	0	0	0	_____	DETUNE	_____		0 ~ 14 (7 center)	
6	0	MTE	_____	_____	NOTE SHIFT	_____				
7	0	_____	_____	_____	VOLUME	_____				
8	.									INST2
16	.									INST3
24	.									INST4
32	.									INST5
40	.									INST6
48	.									INST7
56	.									INST8
64	0	0	0	0	_____	MTBL	_____			
65	0	_____	KEY	_____	_____	EFSEL	— ASMODE			
66	0	_____	_____	_____	PFM NAME 1	_____				
67	0	_____	_____	_____	PFM NAME 2	_____				
.	.				.					
.	.				.					
75	0	_____	_____	_____	PEM NAME 10	_____				

Micro Tune Octave Bulk Data Format

address	b7	b6	b5	b4	b3	b2	b1	b0	data	comment
0	0	_____ MS BYTE of MCT _____						0	13-108	C
	0	_____ LS BYTE of MCT _____						0-63		
1										C#
2										
.										
11										B

Micro Tune Full Bulk Data Format

address	b7	b6	b5	b4	b3	b2	b1	b0	data	comment
0	0	_____ MS BYTE of MCT _____						0	13-108	C-2 (0)
	0	_____ LS BYTE of MCT _____						0-63		
1										C#-2 (1)
2										
.										
127										G8 (127)

Program Change Table Bulk Data Format

address	b7	b6	b5	b4	b3	b2	b1	b0	data	comment
0	0	0	0	0	0	0	0	MSB	0-1	MSB of number PGM1
	0	_____ NUMBER (without MSB) _____						0-127		
1										PGM2
.										
127										PGM127

(Note)

NUMBER		
0-31	:	I1-132
32-63	:	A1-A32
64-95	:	B1-B32
96-127	:	C1-C32
128-159	:	D1-D32
160-183	:	PFM1-PFM24

System Setup Bulk Data Format (SYS)

address	b7	b6	b5	b4	b3	b2	b1	b0	data	comment		
0	0	_____ TUNE _____							0-172	master tune center = 64		
1	0	0	0	_____ MIDBCH _____					0-16	basic rev ch 16:omni		
2	0	0	0	0	_____ MIDTCH _____					0-15	trans ch	
3	0	0	0	0	0	0	PCINF				0-2	p. cng SW
4	0	0	0	_____ COINF _____					0-17	cont.cng SW 1:norm		
5	0	0	0	_____ PBSW _____					0-17	p. bend SW 1:norm		
6	0	0	0	0	0	0	NOTESW				0-2	note on/off 0:all, 1:odd, 2:even
7	0	0	0	0	0	0	0	SYSAVL	0-1	exclusive on/off		
8	0	0	0	0	0	0	0	MLOCK	0-1	mem.protect		
9	0	0	0	0	0	0	0	CMBIN	0-1	combine		
10	0	0	0	0	0	0	0	AT	0-1	after touch		
11	0	_____ ID1 _____							32-127 ID (ascii)			
12	0	_____ ID2 _____										
13	0	_____ ID3 _____										
.												
.												
26	0	_____ ID16 _____										

SPECIFICATIONS

Switches POWER, STORE/EG COPY, UTILITY, EDIT/COMPARE, PLAY/PERFORM, PARAMETER UP, PARAMETER DOWN, DEC, INC, CURSOR LEFT, CURSOR RIGHT, CURSOR

Display 16 character x 2 row backlit LCD

Terminals CASSETTE, MIDI THRU, MIDI OUT, MIDI IN, OUTPUT I/II, PHONES

Power Requirements
 (US and Canadian model) AC 110-120V, 50/60Hz
 (General model) AC 220-240V, 50/60Hz

Power Consumption 8W

Dimensions 480 x 282 x 45.2 mm (WxDxH) (18-15/16" x 11-1/8" x 1-3/4")

Weight 3.4 kg (7 lbs. 8 oz.)

Model TX81Z MIDI Implementation Chart Version : 1.0

Function ...	Transmitted	Recognized	Remarks
Basic Default	1-16	1 - 16	memorized
Channel Changed	1-16	1 - 16	
Mode Default	x	1, 2, 3, 4	memorized
Mode Messages		POLY, MONO(M=1)	
Mode Altered	XXXXXXXXXXXXXXXX	x	
Note Number : True voice	x XXXXXXXXXXXXXXXX	0 - 127 13 - 108	
Velocity Note ON	x	o v=1-127	
Velocity Note OFF	x	x	
After Touch Key's Ch's	x x	x o	X1 : (Breath control)
Pitch Bender	x	o 0-12 semi	X2 : 7 bit resolution
Control Change	1 : x 2 : x 4 : x 5 : x 7 : 10 : x 64 : x 65 : x	o o o o o o o o	X1 : Modulation wheel X1 : Breath control X1 : Foot control X1 : Portamento time (single mode only) X1 : Volume X1 : Pan(I,I+II,II) (performance mode only) Sustain X1 : Portamento
Prog Change : True #	o 0 - 127 XXXXXXXXXXXXXXXX	X3 : o 0 - 127 0 - 183	if pgm cng sw is on.(assignable)
System Exclusive	o	X4 : o	X4 : Voice parameters
System : Song Pos	x	x	
System : Song Sel	x	x	
Common : Tune	x	x	
System : Clock	x	x	
Real Time : Commands	x	x	
Aux : Local ON/OFF	x	x	
Aux : All Notes OFF	x	o (123,126,127)	
Mes- : Active Sense	x	o	
sages : Reset	x	x	
Notes:	X1 = receive if cont. change switch is on. X2 = receive if pitch bend sw is on. X3 = transmit if program change switch is on and system exclusive switch is off. X4 = transmit/receive if system exclusive switch is on.		
Mode 1 : OMNI ON, POLY	Mode 2 : OMNI ON, MONO	o : Yes	
Mode 3 : OMNI OFF, POLY	Mode 4 : OMNI OFF, MONO	x : No	

WHAT'S MIDI?

Musical Instrument Digital Interface (MIDI) is a way for keyboards, synthesizers, sequencers, rhythm machines, and computers to communicate with each other. Devices that have a MIDI jack can be connected together to send and receive information. Since most musical instrument manufacturers have agreed on MIDI, you can connect devices of various manufacturers.

Each piece of information is called a MIDI MESSAGE. Each MIDI message is made up of 1 to 3 bytes (numbers); a Status Byte and 0, 1 or 2 Data Bytes.

The typical MIDI message is in the following form.

Sn. xx. yy

S = Status (8-E)
 n = Channel number (0-F indicates channel 1-16)
 xx = First data byte (00-7F)
 yy = Second data byte (00-7F)

Let's look at a sample 3-byte MIDI message.

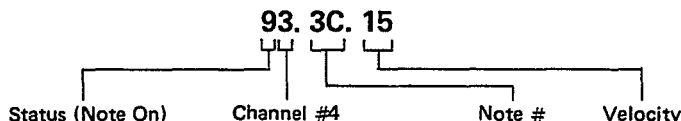

For example, if a DX7 synthesizer receives this message, it does the following.

1. Checks the channel number to see if it is acceptable. If the DX7 has been set to receive that channel, it goes on to the next step. If not, the message is ignored. In the example above, the channel number is 4. (We count 0-F as 1 to 16.)
2. Checks the status. In this case, the status is Note On, so the DX7 knows to expect two more data bytes; note number (what note) and velocity (how hard it was hit).
3. Reads the data bytes and produces the correct note with the correct velocity. (Keep in mind that all this takes a very short time. It takes about 1/1000 of a second to send a MIDI message. To us, it seems as though sound is produced at the same time the key is pressed.)

Some MIDI messages have only two bytes; a status byte and a data byte. For example,

C3. 05

is a Program Change message on channel 4, telling the receiving device to switch to program number 6.

MIDI messages with a status byte from F0 to FF have no channel number. They are called System Messages, and are received by all devices regardless of their channel setting.

For an explanation of each type of message, see the MIDI Format Table on the next page.

MIDI FORMAT TABLE

Binär	Dezimal	Hex.	Binär	Dezimal	Hex.	Binär	Dezimal	Hex.	Binär	Dezimal	Hex.
00000000	0	0	01000000	64	40	10000000	128	80	11000000	192	C0
00000001	1	1	01000001	65	41	10000001	129	81	11000001	193	C1
00000010	2	2	01000010	66	42	10000010	130	82	11000010	194	C2
00000011	3	3	01000011	67	43	10000011	131	83	11000011	195	C3
00000100	4	4	01000100	68	44	10000100	132	84	11000100	196	C4
00000101	5	5	01000101	69	45	10000101	133	85	11000101	197	C5
00000110	6	6	01000110	70	46	10000110	134	86	11000110	198	C6
00000111	7	7	01000111	71	47	10000111	135	87	11000111	199	C7
00001000	8	8	01001000	72	48	10001000	136	88	11001000	200	C8
00001001	9	9	01001001	73	49	10001001	137	89	11001001	201	C9
00001010	10	A	01001010	74	4A	10001010	138	8A	11001010	202	CA
00001011	11	B	01001011	75	4B	10001011	139	8B	11001011	203	CB
00001100	12	C	01001100	76	4C	10001100	140	8C	11001100	204	CC
00001101	13	D	01001101	77	4D	10001101	141	8D	11001101	205	CD
00001110	14	E	01001110	78	4E	10001110	142	8E	11001110	206	CE
00001111	15	F	01001111	79	4F	10001111	143	8F	11001111	207	CF
00010000	16	10	01010000	80	50	10010000	144	90	11010000	208	C0
00010001	17	11	01010001	81	51	10010001	145	91	11010001	209	D1
00010010	18	12	01010010	82	52	10010010	146	92	11010010	210	D2
00010011	19	13	01010011	83	53	10010011	147	93	11010011	211	D3
00010100	20	14	01010100	84	54	10010100	148	94	11010100	212	D4
00010101	21	15	01010101	85	55	10010101	149	95	11010101	213	D5
00010110	22	16	01010110	86	56	10010110	150	96	11010110	214	D6
00010111	23	17	01010111	87	57	10010111	151	97	11010111	215	D7
00011000	24	18	01011000	88	58	10011000	152	98	11011000	216	D8
00011001	25	19	01011001	89	59	10011001	153	99	11011001	217	D9
00011010	26	1A	01011010	90	5A	10011010	154	9A	11011010	218	DA
00011011	27	1B	01011011	91	5B	10011011	155	9B	11011011	219	DB
00011100	28	1C	01011100	92	5C	10011100	156	9C	11011100	220	DC
00011101	29	1D	01011101	93	5D	10011101	157	9D	11011101	221	CD
00011110	30	1E	01011110	94	5E	10011110	158	9E	11011110	222	DE
00011111	31	1F	01011111	95	5F	10011111	159	9F	11011111	223	DF
00100000	32	20	01100000	96	60	10100000	160	A0	11100000	224	E0
00100001	33	21	01100001	97	61	10100001	161	A1	11100001	225	E1
00100010	34	22	01100010	98	62	10100010	162	A2	11100010	226	E2
00100011	35	23	01100011	99	63	10100011	163	A3	11100011	227	E3
00100100	36	24	01100100	100	64	10100100	164	A4	11100100	228	E4
00100101	37	25	01100101	101	65	10100101	165	A5	11100101	229	E5
00100110	38	26	01100110	102	66	10100110	166	A6	11100110	230	E6
00100111	39	27	01100111	103	67	10100111	167	A7	11100111	231	E7
00101000	40	28	01101000	104	68	10101000	168	A8	11101000	232	E8
00101001	41	29	01101001	105	69	10101001	169	A9	11101001	233	E9
00101010	42	2A	01101010	106	6A	10101010	170	AA	11101010	234	EA
00101011	43	2B	01101011	107	6B	10101011	171	AB	11101011	235	EB
00101100	44	2C	01101100	108	6C	10101100	172	AC	11101100	236	EC
00101101	45	2D	01101101	109	6D	10101101	173	AD	11101101	237	ED
00101110	46	2E	01101110	110	6E	10101110	174	AE	11101110	238	EE
00101111	47	2F	01101111	111	6F	10101111	175	AF	11101111	239	EF
00110000	48	30	01110000	112	70	10110000	176	B0	11110000	240	F0
00110001	49	31	01110001	113	71	10110001	177	B1	11110001	241	F1
00110010	50	32	01110010	114	72	10110010	178	B2	11110010	242	F2
00110011	51	33	01110011	115	73	10110011	179	B3	11110011	243	F3
00110100	52	34	01110100	116	74	10110100	180	B4	11110100	244	F4
00110101	53	35	01110101	117	75	10110101	181	B5	11110101	245	F5
00110110	54	36	01110110	118	76	10110110	182	B6	11110110	246	F6
00110111	55	37	01110111	119	77	10110111	183	B7	11110111	247	F7
00111000	56	38	01111000	120	78	10111000	184	B8	11111000	248	F8
00111001	57	39	01111001	121	79	10111001	185	B9	11111001	249	F9
00111010	58	3A	01111010	122	7A	10111010	186	BA	11111010	250	FA
00111011	59	3B	01111011	123	7B	10111011	187	BB	11111011	251	FB
00111100	60	3C	01111100	124	7C	10111100	188	BC	11111100	252	FC
00111101	61	3D	01111101	125	7D	10111101	189	BD	11111101	253	FD
00111110	62	3E	01111110	126	7E	10111110	190	BE	11111110	254	FE
00111111	63	3F	01111111	127	7F	10111111	191	BF	11111111	255	FF

MIDI MESSAGES

<i>8n Note Off:</i>	The note number indicates which key was released, and velocity indicates how quickly it was released. Very few keyboards have Release Velocity Sensitivity.
<i>9n Note On:</i>	The note number indicates which key was pressed, and velocity indicates how hard it was hit. On keyboards which do not have a velocity sensitive keyboard, a medium value of 40 is sent. A Note On message with a velocity of 0 is the same as a Note Off message.
<i>An Polyphonic Aftertouch:</i>	The note number indicates which key is being pressed, and pressure indicates how hard that key is being pressed. (i.e., each key can send independent after-touch messages;)
<i>Bn Control Change:</i>	The control number indicates which controller is being moved, and the data indicates the position of the controller. Continuous controllers (slider or wheel-type controllers) carry data in the range of 00-7F. Switch-type controllers (eg. sustain pedal) carry either 00 (off) or 7F (on). Control changes 7A-7F are called Mode Messages, and usually carry a fixed data byte. They tell the receiving tone generator how to behave. The way in which these message are interpreted will depend on the device. (See the MIDI Implementation Chart for your tone generator or synthesizer.)
<i>Cn Program Change:</i>	This tells the receiving device to switch programs (memories).
<i>Dn Channel Aftertouch:</i>	Also called "Common After-touch", this is found on the DX7. It indicates the strongest pressure on any part of the keyboard, ie, the "common" value.
<i>En Pitch Wheel:</i>	To provide finer resolution, this data is sent in two bytes, first the Least Significant Byte (LSB) and then the Most Significant Byte (MSB). Yamaha tone generators and synthesizers ignore the LSB.
<i>F0 System Exclusive:</i>	After F0 must come an identification number which has been assigned to each manufacturer. Yamaha's number is 43. What comes between this message and F7 (End of Exclusive) is completely up to each manufacturer (but each byte must be from 00 to 7F). Yamaha uses System Exclusive messages to transmit voice data, sequence data, rhythm pattern data, bulk memory data of all kinds, and many other useful things. See the System Exclusive format chart for your device.
<i>F7 End Of Exclusive: (EOX)</i>	This marks the end of a System Exclusive message.
<i>F2,F3,F8,FA,FB,FC,FF:</i>	Song Position Pointer, Song Select, Timing Clock, Start, Stop, Continue, System Reset are all for controlling sequencers and rhythm machines. See the MIDI Implementation Chart for your device.
<i>FE Active Sensing:</i>	If there are no MIDI messages that have to be sent, one of these is sent just to let the receiving devices know that there is still someone out there. If there have not been any MIDI messages for longer that 300 msec, the receiving device assumes that some error has taken place (e.g., a MIDI cable was pulled out by mistake) and will stop all notes.
<i>F1, F4, F5, F9, FD:</i>	These are unused, and reserved for future expansion.

WHAT'S FM?

A complete discussion of FM Synthesis is beyond the scope of this manual. Here we will cover the basic ideas of FM, and briefly explain each TX81Z voice parameter. For a more detailed study, see "FM Theory & Applications: By Musicians for Musicians", by Dr. John Chowning and David Bristow, published 1986 by Yamaha Music Foundation.

FREQUENCY MODULATION

FM stands for Frequency Modulation. In FM, one waveform modulates another waveform, creating a new, complex waveform, as shown below. So, to do FM synthesis, we need two oscillators. The upper one is called the "Modulator" and the lower one (which goes directly to the output of the synthesizer) is called the "Carrier". The complexity or "brightness" of the resulting waveform will depend on the output level of the Modulator.

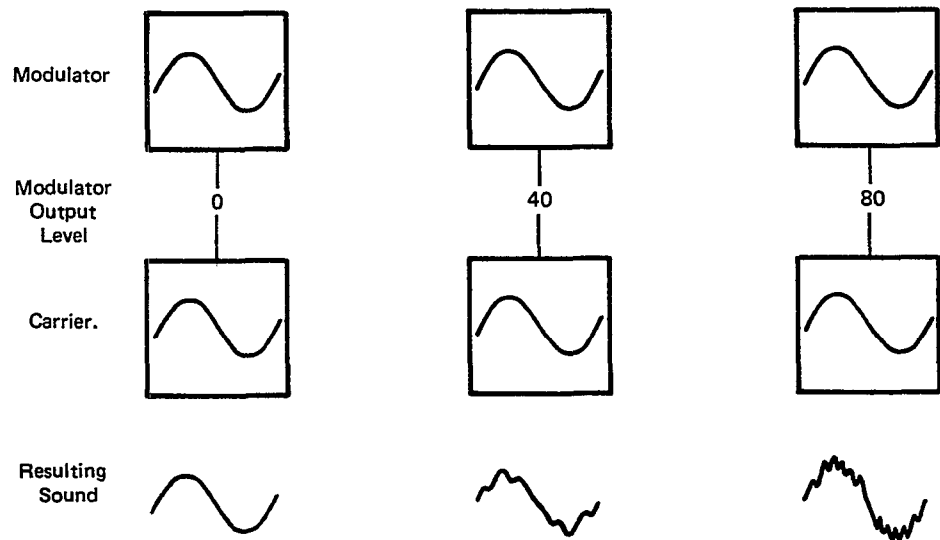

EG (Envelope Generator)

By varying the output level of the modulator, we can produce all kinds of sounds. However, sounds in the real world usually change as time goes by. This "shape in time" is called the Envelope. A synthesizer simulates this using an Envelope Generator to change the output level of each operator. If the output level of the modulator changes, the tone will change. If the output level of the carrier changes, the volume will change.

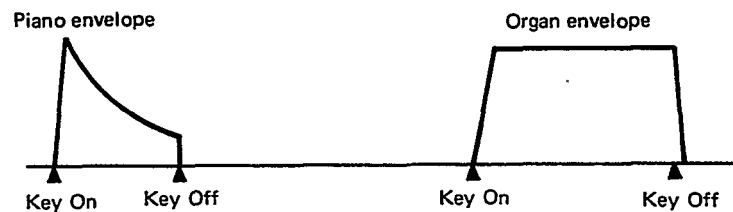

OPERATOR

In Yamaha FM synthesizers, each oscillator has its own Envelope Generator (EG) to vary its output level over time. This "package" of oscillator + EG is called an Operator. An operator can be either a modulator or carrier. The only difference is how it is used.

ALGORITHM

To do simple FM, you need only two operators, but the TX81Z has four, and these four operators can be arranged in 8 different ways. Each arrangement is called an Algorithm. The eight algorithms are shown on the pull-out operation guide under the TX81Z LCD display. Take a look at them. Algorithm 1 has only one carrier. The other three operators are all used as modulators. In algorithm 6, one modulator modulates three carriers. Algorithm 8 has four carriers and no modulators.

FEEDBACK

In the algorithm chart, you will also notice that operator 4 has its output connected to its input. This means that it can modulate itself, a bit like having an additional operator.

RATIO FREQUENCY

The basic frequency of each operator can be set independently. When an operator is in Ratio mode, it will produce a frequency corresponding to the key that was pressed. If the frequency ratio of the carrier:modulator is 1:1, the resulting sound will contain all the harmonic partials. For example, if the fundamental (the "basic pitch") is 100Hz, harmonics of 200Hz, 300Hz, 400Hz ... will be generated. If the frequency ratio is 1:2, the odd-numbered harmonic partials will be generated (100Hz, 300Hz, 500Hz ...), creating a hollow, reedy sound. Irregular ratios (such as 1:1.37) will generate non-harmonic spectra typical of clashing, metallic sounds.

FIXED FREQUENCY

An operator can also be set to Fixed mode, when it will produce the same frequency regardless of what key is pressed. In Fixed mode, the frequency is displayed in Hz (cycles per second) or KHz (1000 cycles per second). If the carrier is in Ratio mode and the modulator is in Fixed, the harmonic structure of the sound will change depending on the key you press, since the carrier:modulator ratio will change note by note.

WAVE

Until the TX81Z, the FM operators in Yamaha's previous synthesizers produced only sine waves (a pure tone). However, the TX81Z operators give you a choice of 8 different waveforms (sine and 7 others) for each operator. FM synthesis with non-sinewave operators is still a relatively unexplored field. It may help you to look through the factory preset voices to see how they use the different waveforms.

LFO

The LFO (Low Frequency Oscillator) produces a slow (about 0.007Hz to 50Hz) vibration that can be used to create vibrato, tremolo or other effects. If the LFO is affecting the output level of a carrier, the result will be Tremolo (rapid variance in volume), and if it is affecting the output level of a modulator, the result will be periodic changes in tone. The LFO can also control the pitch of the entire voice, producing Vibrato (rapid variance in pitch).

SENSITIVITY

Acoustic instruments produce different sounds when played softly or loudly. Not only the loudness, but also the tone changes. A softly played note is usually softer in tone as well. FM synthesis provides an easy way to simulate this. Each operator can be "Velocity Sensitive", and adjust its output level according to how hard a key was struck (key velocity). If a carrier is velocity sensitive, the volume will depend on the key velocity. If a modulator is velocity sensitive, the tone will depend on the key velocity.

What's FM?

DETUNE

The harmonic structure of actual acoustic sounds is usually somewhat "irregular". This makes them sound interesting and lifelike. By slightly Detuning each operator, you can create this type of naturally irregular harmonic structure.

SCALING

The tonal characteristics of an instrument generally change from note to note. For example, high notes on a piano have a simpler harmonic structure than the bass notes. By Scaling the output level of a modulator to decrease as you play up the keyboard, you can simulate this. High notes on many instruments also have a shorter envelope. You can simulate this by using Rate Scaling.

***LEARNING FM
SYNTHESIS***

It is rather time-consuming to create a voice from the initial setting, since you would have to set most (or all) of the 92 parameters that make up each voice. The best way to learn is to get inside the factory preset voices and see how they work. Turn each operator off one by one, and see how each operator affects the sound. Make small changes in operator output level or EG rates. Try starting from a preset voice that is fairly close to what you have in mind, and edit it to your liking.

INDEX

A Mod Sensitivity	16	Full Time Portamento	21	Performance Transmit	26
AMD (LFO)	15	Function	21	Performance Utility	42
Algorithm	13	Greeting Message	46	Pitch Bend	26
Assign Mode	38	Init Full (micro tune)	32	Pitch Bend Range	21
Attack Rate (AR)	19	Init Octave (micro tune)	31	Pitch Shift (effect)	29
BC Amplitude	22	Init Performance	42	Play Performance	35
BC Pitch Bias	22	Init Voice	32	Play Single	11
BC EG Bias	22	Init. Program Cng. Tbl.	26	Poly Mode	21
BC Pitch	22	Inst Detune	39	Portamento Time	21
Cassette Control	28	Key Number Mode	25	Program Change	25
Chord Effect	30	Key Velocity Sensitivity	16	Range (pan effect)	30
Coarse (frequency)	17	LFO	14	Rate Scaling	20
Combine	27	LFO Select	40	Ratio (frequency)	17
Compare	13	Level Scaling	20	Recall Edit	32
Control Change	25	Limit L/H	39	Edit Recall	32
Decay Level (D1L)	19	Load 1 Performance	29	Receive Ch. (performance)	39
Decay Rate (D1R, D2R)	19	Load 1 Voice	29	Receive Channel	25
Delay (LFO)	15	Load 24 Performance	29	Release Rate (RR)	19
Delay Effect	29	Load 32 Voice	28	Reverb Rate	23
Delay Time (effect)	29	Load Setup	29	Save 24 Performance	29
Detune (operator)	18	MIDI Control	25	Save 32 Voice	28
Direction (pan effect)	30	MIDI Note Indicator	46	Save Setup	29
EG Bias Sensitivity	16	MW Amplitude	22	Scaling	20
EG Copy	19	MW Pitch	22	Select (pan effect)	30
EG Shift (EGS)	19	Master Tune	24	Sensitivity	16
Edit Full (micro tune)	32	Master Volume	3	Setup Transmit	26
Edit Octave (micro tune)	31	Max Notes	38	Single Mode	10
Edit Performance	37	Memory Protect	27, 45	Speed (LFO)	15
Edit Program Cng. Tbl.	27	Micro Tune	31	Store Performance	36
Edit single	12	Micro Tune (performance)	41	Store Voice	11
Effect 1 (delay)	29	Middle C	22	Sync (LFO)	15
Effect 2 (pan)	30	Minimum Volume	46	Transmit Channel	25
Effect 3 (chord)	30	Modes (TX81Z)	5	Transpose (voice)	22
Effect Level (delay)	30	Mono Mode	21	Utility (performance)	42
Effect Select	41	Name (performance)	41	Utility (single)	24
Envelope Generator (EG)	18	Name (voice)	23	Verify 24 Performance	29
Exclusive	26	Note Shift	40	Verify 32 Voice	28
FC Amplitude	22	Operator Output Level	20	Verify Setup	29
FC Pitch	22	Oscillator wave	18	Voice Edit	42
FC Volume	21	Out Assign	40	Voice No. (performance)	38
Feedback (voice)	13	P Mod Sensitivity	16	Voice Transmit	26
Feedback (effect)	29	PMD (LFO)	15	Volume (performance)	40
Fine (frequency)	17	Pan Effect	30	Wave (LFO)	15
Fingered Portamento	21	Performance Memory	35		
Fix (frequency)	17	Performance Mode	34		
Frequency	17	Performance Name	41		

SERVICE

The TX81Z is supported by Yamaha's worldwide network of factory trained and qualified dealer service personnel. In the event of a problem, contact your nearest Yamaha dealer.

FCC INFORMATION (for United States Customers Only)

While the following statement is provided to comply with FCC regulations in the United States, the corrective measures listed are applicable worldwide.

“WARNING — This equipment has been certified to comply with the limits for a Class B computing device, pursuant to Subpart J of Part 15 of FCC Rules. Only peripherals (computer input/output devices, terminals, printers, etc.), certified to comply with the Class B limits may be attached to this computer. Operation with non-certified peripherals is likely to result in interference to radio and TV reception.”

The TX81Z and its accessories have been tested and certified to be in compliance with the limits established for this class of equipment pursuant to FCC Rules Part 15, Subpart J. These limits were established to provide a reasonable measure of protection against such interference; however, this does not guarantee that interference will not occur. If the TX81Z equipment is suspected of causing interference with other electronic equipment, verification can be made by turning off the TX81Z.

If the interference continues, then the TX81Z is not the source of the interference. If the TX81Z does appear to be the source of the interference, you should try to correct the situation by one or more of the following measures.

- Relocate either the TX81Z and its accessories or the electronic equipment that is being affected by the interference.
- Utilize power outlets for the TX81Z and the equipment being affected that are on different branch circuits (utilizing different circuit breakers or fuses), or install AC line filters.
- In the case of radio interference, relocate the antenna. If the antenna cable is 300 ohm ribbon lead, have it changed to 75 ohm coaxial cable (utilizing the necessary transformer/adaptors at either end, as required to match the cable).

If these corrective measures do not produce satisfactory results, please contact a Yamaha Retailer authorized to sell this product for suggestions and/or corrective measures. If you cannot locate a Yamaha Retailer authorized to sell this product in your general area, please contact the Yamaha International Corporation. MMC Service Division, 6600 Orangethorpe Avenue, Buena Park, CA 90620, USA.

If for any reason you should need additional information relating to radio and TV interference, you may find a booklet prepared by the Federal Communications Commission helpful: “How to Identify and Resolve Radio/TV Interference Problems.” This booklet, Stock #004-000-00345-4, is available from the U.S. Government Printing Office, Washington D.C. 20402.

YAMAHA[®]

Yamaha Corporation of America
6600 Orangethorpe Avenue, P.O. Box 6600, Buena Park, CA 90622-6600
2/24/98 27895
TX81Z OM



Recyclable



Recycled