

M300

DUAL ENGINE PROCESSOR



USER'S MANUAL

IMPORTANT SAFETY INSTRUCTIONS



The lightning flash with an arrowhead symbol within an equilateral triangle, is intended to alert the user to the presence of uninsulated "dangerous voltage" within the product's enclosure that may be of sufficient magnitude to constitute a risk of electric shock to persons.



The exclamation point within an equilateral triangle is intended to alert the user to the presence of important operating and maintenance (servicing) instructions in the literature accompanying the product.

- 1 Read these instructions.
- 2 Keep these instructions.
- 3 Heed all warnings.
- 4 Follow all instructions.
- 5 Do not use this apparatus near water.
- 6 Clean only with dry cloth.
- 7 Do not block any ventilation openings. Install in accordance with the manufacturer's instructions.
- 8 Do not install near any heat sources such as radiators, heat registers, stoves, or other apparatus (including amplifiers) that produce heat.
- 9 Do not defeat the safety purpose of the polarized or grounding-type plug. A polarized plug has two blades with one wider than the other. A grounding type plug has two blades and a third grounding prong. The wide blade or the third prong are provided for your safety. If the provided plug does not fit into your outlet, consult an electrician for replacement of the obsolete outlet.
- 10 Protect the power cord from being walked on or pinched particularly at plugs, convenience receptacles, and the point where they exit from the apparatus.
- 11 Only use attachments/accessories specified by the manufacturer.
- 12 Unplug this apparatus during lightning storms or when unused for long periods of time.
- 13 Refer all servicing to qualified service personnel. Servicing is required when the apparatus has been damaged in any way, such as power-supply cord or plug is damaged, liquid has been spilled or objects have fallen into the apparatus, the apparatus has been exposed to rain or moisture, does not operate normally, or has been dropped.

Warning!

- To reduce the risk of fire or electric shock, do not expose this apparatus to rain or moisture.
- This apparatus must be earthed.
- Use a three wire grounding type line cord like the one supplied with the product.
- Be advised that different operating voltages require the use of different types of line cord and attachment plugs.
- Check the voltage in your area and use the correct type. See table below:

Voltage	Line plug according to standard
110-125V	UL817 and CSA C22.2 no 42.
220-230V	CEE 7 page VII, SR section 107-2-D1/IEC 83 page C4.
240V	BS 1363 of 1984. Specification for 13A fused plugs and switched and unswitched socket outlets.

- This equipment should be installed near the socket outlet and disconnection of the device should be easily accessible.
- Do not install in a confined space.
- Do not open the unit - risk of electric shock inside.

Caution:

You are cautioned that any change or modifications not expressly approved in this manual could void your authority to operate this equipment.

Service

- There are no user-serviceable parts inside.
- All service must be performed by qualified personnel.

IMPORTANT SAFETY INSTRUCTIONS

EMC / EMI.

This equipment has been tested and found to comply with the limits for a Class B Digital device, pursuant to part 15 of the FCC rules. These limits are designed to provide reasonable protection against harmful interference in residential installations. This equipment generates, uses and can radiate radio frequency energy and, if not installed and used in accordance with the instructions, may cause harmful interference to radio communications. However, there is no guarantee that interference will not occur in a particular installation. If this equipment does cause harmful interference to radio or television reception, which can be determined by turning the equipment off and on. The user is encouraged to try to correct the interference by one or more of the following measures:

- Reorient or relocate the receiving antenna.
- Increase the separation between the equipment and receiver.
- Connect the equipment into an outlet on a circuit different from that to which the receiver is connected.
- Consult the dealer or an experienced radio/TV technician for help.

For the customers in Canada:

This Class B digital apparatus complies with Canadian ICES-003.
Cet appareil numérique de la classe B est conforme à la norme NMB-003 du Canada.

Certificate Of Conformity

TC Electronic A/S, Sindalsvej 34, 8240 Risskov, Denmark, hereby declares on own responsibility that following products:

M300 - Dual Engine Processor

- that is covered by this certificate and marked with CE-label conforms with following standards:

EN 60065 (IEC 60065)	Safety requirements for mains operated electronic and related apparatus for household and similar general use
EN 55103-1	Product family standard for audio, video, audio-visual and entertainment lighting control apparatus for professional use. Part 1: Emission.
EN 55103-2	Product family standard for audio, video, audio-visual and entertainment lighting control apparatus for professional use. Part 2: Immunity.

With reference to regulations in following directives:
73/23/EEC, 89/336/EEC

Issued in Risskov, March 2002
Anders Fauerskov
Chief Executive Officer

TABLE OF CONTENTS

INTRODUCTION

<i>Table of Contents</i>	3
<i>Introduction</i>	5
<i>Front Panel Overview</i>	6
<i>Rear Panel Overview</i>	8
<i>Signal Flow Diagram</i>	9
<i>Typical M300 Setups</i>	10

APPENDIX

<i>MIDI Implementation Chart</i>	30
<i>MIDI Continuous Controllers</i>	31
<i>Reset Procedure</i>	31
<i>MIDI Bulk Dump</i>	31
<i>Technical Specifications</i>	32

BASIC OPERATION

<i>How To Operate the M300</i>	
<i>Input/Output Section</i>	16
<i>The Multi-effects Engine</i>	18
<i>The Reverb Engine</i>	20
<i>Store</i>	21
<i>Recall</i>	21
<i>The Display</i>	21
<i>Miscellaneous</i>	
<i>Factory Presets</i>	22
<i>MIDI channel</i>	22
<i>Sysex ID</i>	22
<i>M300 software</i>	22
<i>Routings</i>	23

EFFECTS

<i>Multi-effects</i>	
<i>Dynamic Delay</i>	24
<i>Tape Delay</i>	24
<i>Studio Delay</i>	25
<i>Delay</i>	25
<i>PingPong Delay</i>	25
<i>SlapBack Delay</i>	25
<i>Phaser</i>	25
<i>Tremolo</i>	25
<i>Chorus</i>	26
<i>Compressor</i>	26
<i>De-Esser</i>	27
<i>Reverbs</i>	
<i>Reverb types</i>	28

QUICK START - IF YOU JUST CAN'T WAIT

If you just can't wait to hear the great effects waiting for you in your new M300 Dual Effects processor, follow the few steps in this quick setup guide:

- Unpack the M300 and check for possible damages that could have been caused by transport.
- Read the safety instructions.
- Take a few minutes to register online via: www.tcelectronic.com or send in the registration card. Customers registered online will be notified directly via E-Mail about new tips&tricks and manual updates.

Consider the M300 as two effects processors in one box. We call these two processors "Engines". The Multi-Effect Engine creates one of the following effects: Delay, Chorus, Flanger, Phaser, Tremolo, De-Ess or Compression. The Reverb Engine creates Reverb. These two Engines can be used separately or in conjunction.

Connections & Routing:

The M300 has two routing options that require two different ways of connecting. The Routing mode is set on the M300 rear panel and should correspond to your current setup.

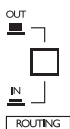

Serial mode

Dual Send/Return mode

Serial Routing (switch in **OUT** position)

- utilizing both effect Engines in serial.

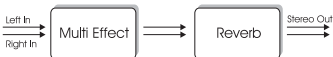

Dual Send/Return (switch in **IN** position)

- ideal if you need to send signal from two different AUX sends on your mixer and return on a stereo Aux or two other channels.

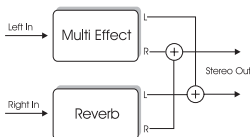

For detailed explanations on Routings and connections please read page 22.

- When all audio connections are made connect power.
- Set the M300 in Preset Off mode using the PRESET ON/OFF key:

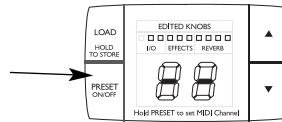

The M300 is in Preset Off mode when the display reads as illustrated above.

- **Set all controls in 12 o'clock position to hear factory settings.**
(For Dual Send/Return mode set MIX to 100%)
- Select an Effect from the Multi-effects section
- Select a Reverb type from the Reverb Section.
- Start playing music through the M300.
- Adjust Input level to a level just below the point where the two INPUT PPMs turn red.
- Set the desired Mix between the Dry and Wet signal of the entire M300 using the MIX control.
- Set the desired balance between the Multi-Effects section and the Reverb section using the EFFECT BALANCE knob.
- Now tweak the controls for the two sections until you have the effects intended.
(When using the Dual Send/Return mode always set MIX to 100%)

For any questions left unanswered by this manual feel free to visit our online support center; **TC Support Interactive**, which can be accessed via: www.tcelectronic.com



Latest manual revision can always be downloaded from www.tcelectronic.com

INTRODUCTION

Congratulations on the purchase of your TC Electronic M300 Dual Engine processor.

The M300 is a Dual Engine effects processor that is extremely easy to use. Making no compromises when it comes to quality we proudly present the M300 in the affordable price range. With top quality effects and the intuitive user-interface we are convinced that you will enjoy the M300 now and in the future. The M300 is so easy to use that this manual may seem nearly redundant to the front panel itself.

However, read on for explanations of basic setups and routing-options to achieve maximum performance from your new M300.

The Dual Engine Structure lets you combine various effects with high quality Reverbs.

Engine 1

- Dynamic Delay
- Studio Delay
- Tape Delay
- Delay
- PingPong Delay
- SlapBack Delay
- Vintage Phaser
- Phaser
- Hard Tremolo
- Soft Tremolo
- Flanger 1 & 2
- Chorus
- Compressor
- De-Esser
- Off

Engine 2

- Concert Hall
- Living Room
- Club
- Plate I
- Plate II
- Spring
- "Live" Reverb
- Ambience
- TC Classic Hall
- Vocal Studio
- Vocal Room
- Vocal Hall
- Drum Box
- Drum Room
- Large Cathedral
- Off

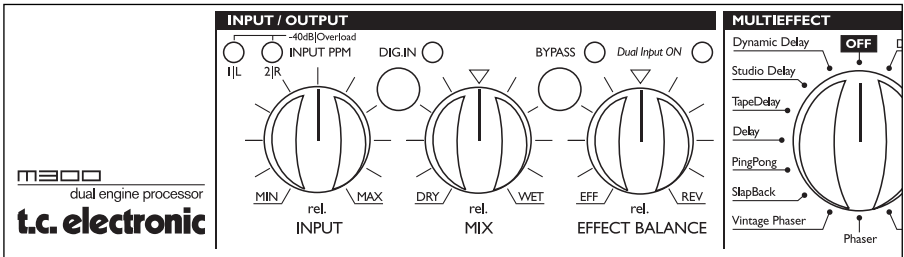

FRONT PANEL OVERVIEW

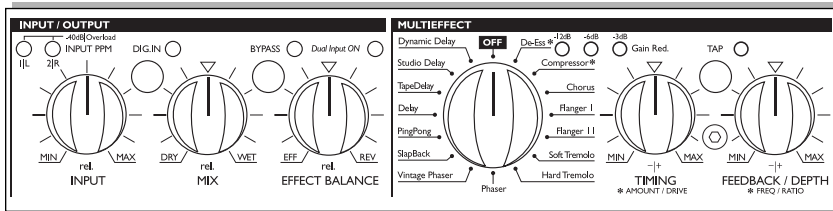

INPUT knob

Adjusts the Input level.

1/L and 2/R LEDs

3 color LEDs indicating Input level on Left and Right Inputs.

Green : -40dB
Yellow : -6dB
Red : -1dB

MIX knob

Adjusts the mix between the wet and the dry signal. 100% "Wet" is achieved at fully clockwise position.

EFFECTS BALANCE knob

Adjusts the balance between the Effects Engine and the Reverb Engine. Maximum effect from both Engines is achieved at 12 o'clock position.

DIGI IN button and LED

LED Off

Digital Input is set to Off. The M300 processes only the signal present on the Analog Inputs.

LED Green

The M300 is locked correctly to the Digital Input signal.

LED Flashing

Digital In is selected but no digital signal is received or the signal is corrupt. The M300 automatically returns to internal clock and Analog operation.

BYPASS knob and LED

Bypass function varies depending on the selected Routing (set on the rear panel):

Dual Send Return routing:

Bypass operates as "mute".

Serial routing:

Bypass routes the Input signal to Output.

MULTI-EFFECT selector

Selects between the 15 effects & Off in the Multi-effects Engine.

TIMING knob & TAP key

Tap the global tempo using the TAP key by tapping quarter notes. Now use the timing knob to multiply the tapped tempo.

The range varies from 0.5 to 2.

Example:

- Tap quarter notes at Tempo 120 BPM. This equals 500 milliseconds.
- The range of the TIMING knob is 0.5 to 2 giving you a Delay time varying from: 250ms to 1000ms. Note that the Slapback Delay type has a shorter range as the Slapback Delay type by nature is a short Delay.

TIMING knob as

AMOUNT/DRIVE control

For the Compressor and De-Ess algorithms (marked with an "*"*) this knob has different functions:

De-Ess : Amount
Compressor : Drive

FEEDBACK/DEPTH knob

Controls the Feedback or Depth parameter depending of the selected effect.

Delay : Feedback
Phasor : Depth
Tremolo : Depth
Flange : Depth
Chorus : Depth

FEEDBACK/DEPTH knob as

FREQ/RATIO control

For the Compressor and De-Ess algorithms (marked with an "*"*) this knob has different functions:

De-Ess : Frequency
Compressor : Ratio

-3, -6, -12 LEDs

These LEDs indicate the applied gain-reduction when Compressor or De-Ess algorithms are selected. It is worth noticing that the Compressor uses Automatic Make-up Gain to naturally compensate for the decreased gain.

FRONT PANEL OVERVIEW

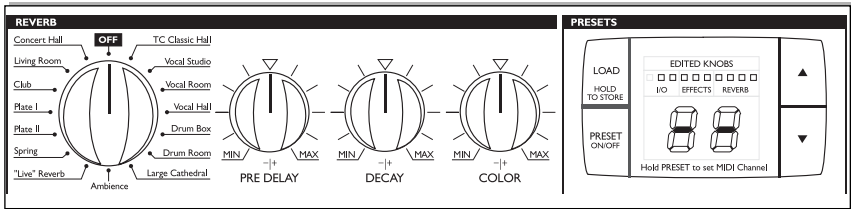

REVERB Type selector

Selects between 15 different Reverb types or sets the Reverb Engine to "Off".

PRE DELAY knob

Controls the relative Pre Delay of the selected Reverb.

DECAY knob

Controls the relative Decay of the selected Reverb.

COLOR knob

Controls the relative Color of the selected Reverb.

LOAD/HOLD TO STORE key

This key has two functions.

- Press once to load the preset selected via the CURSOR UP/DOWN keys.
- Press and hold to store the current preset.

PRESET ON/OFF key

The M300 has two preset modes.

Preset "Off" mode:

The display reads as illustrated above - no numbers.

In this mode the M300 will play effects according to the front panel controls.

When going from Preset "On" to Preset "Off" mode the effects will always be updated according to the positions of the front controls.

Preset "On" mode:

The display reads a specific preset number.

In this mode you can recall various user presets by using the UP/DOWN arrows followed by LOAD.

(Note that the M300 holds no stored factory presets apart from the default settings in the various effects).

Toggling between the Preset On/ Preset Off modes generates two situations:

From "On" to "Off":

Preset is updated according to the positions of the front controls.

From "Off" to "On":

The display starts to blink the previously recalled preset number while still processing according to the front controls. To actually load the preset press LOAD.

Set MIDI channel

Press and hold the PRESET ON/OFF key approx. 2.5 sec. Now set the desired MIDI channel 1 to 16 or "o" for OMNI (receives on all channels) or OF for Off, using the ARROW UP/DOWN keys. Via this menu a Bulk Dump can also be performed. (see page 31). Press PRESET ON/OFF key once to exit the MIDI channels set mode.

EDITED KNOBS LEDs

The LEDs are relevant in Preset "On" mode only. They indicate when the front controls do not match the settings in the actually recalled preset.

ARROW UP/DOWN keys

Scroll between presets when in Preset "On" mode.

REAR PANEL

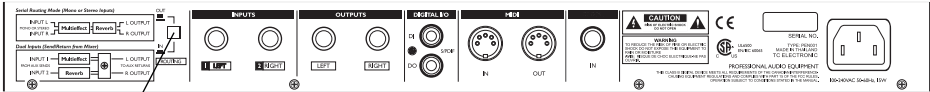

Routing Switch

Balanced Jack
Analog Inputs

Balanced Jack
Analog Outputs

Digital S/PDIF
Input/Output

MIDI In/Out

Pedal Input

Power Input
100 - 240V

ROUTING switch

Switches between Dual Send/Return and Serial Input modes.

Dual Send/Return mode:

Switch is In, and Green LED on front is On.

Serial mode:

Switch is Out and Green LED on front is Off.

Read much more about these Routing options on pages 22/23. See also the suggested setups on pages 10-15.

Analog Input

Analog Input on 1/4 inch connectors.

Use Left Input for connecting a mono signal.



If you connect to Left Input only and use Dual Send Return mode the Input signal is fed to both the Multi-effects Engine and the Reverb Engine, and you can then use the M300 as two independent effect units with a common Output.

Analog Output

Analog Output is a Stereo Output on two 1/4" Jack connectors.

Pedal Input

The Pedal Input gives you the possibility to Bypass and "tap" the Global Tempo via momentary switches. The Global tempo can be used to set Delay time.

The connection is a 1/4" Stereo Jack with Bypass on tip and Tap Tempo on ring.

SIGNAL FLOW

M-300

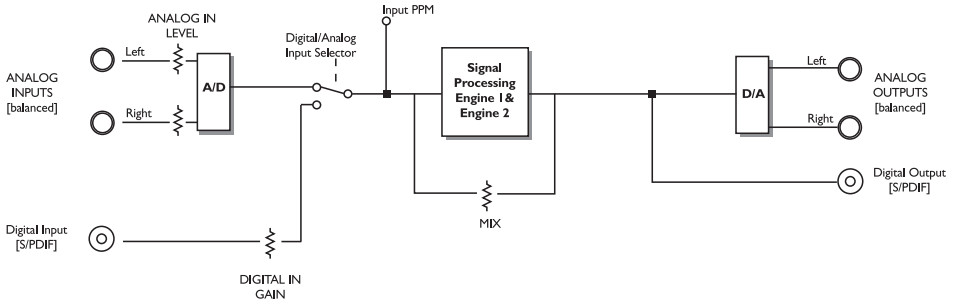

MIDI Cable

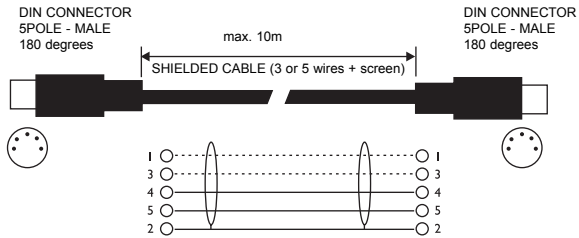

Jack Cable Mono to Mono

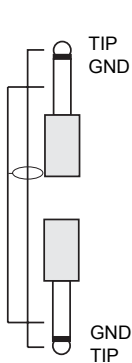

Jack Cable Stereo

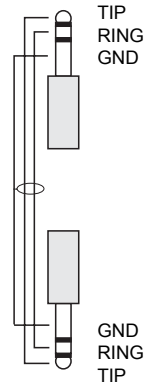

TYPICAL SETUPS

Connecting and Setting up the M300

Setting up the M300 is very easy. It is, however, important to connect and setup the M300 correctly according to your application. Setting up basically means: connecting, selecting one of the two routing options via the switch on the rear panel and finally setting the MIX control on the front panel. Find the setup you are about to create or similar on the following two pages - and follow the instructions.

Setup

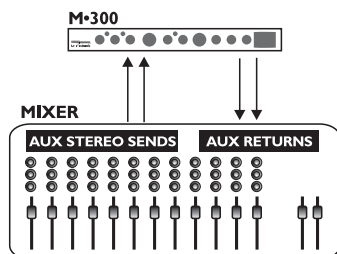

M300 Routing Schematic

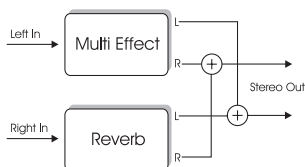

Dual Send/Return

This setup applies to a mixer with two (or more) AUX sends. It utilizes the two effect sections in the M300 as two separate effects with a common Output.

- On the rear panel select DUAL S/R routing by leaving the switch in the "IN" position.
- Connect AUX 1 send to the M300 Left Input.
- Connect AUX 2 send to the M300 Right Input.
- Connect the M300 Left and Right Outputs to the Stereo AUX L/R returns of either AUX 1 or AUX 2.
- Set MIX to 100% wet, as you in this setup do not want the direct signal to pass the M300.
- Set Input level to 12 o'clock position.
- Set BALANCE to 12 o'clock position.
- Select Reverb type and Multi-effect type using the selectors on the front panel.
- Set the AUX Return level on the mixer to approx. 50%.
- Now slowly turn up the AUX Sends 1 and 2 on the mixer for the channels you wish to add effect to.
- Adjust/fine-tune the M300 Input level so the Input LED on the front panel often is Orange but only rarely peaks at Red color.

TYPICAL SETUPS

Setup

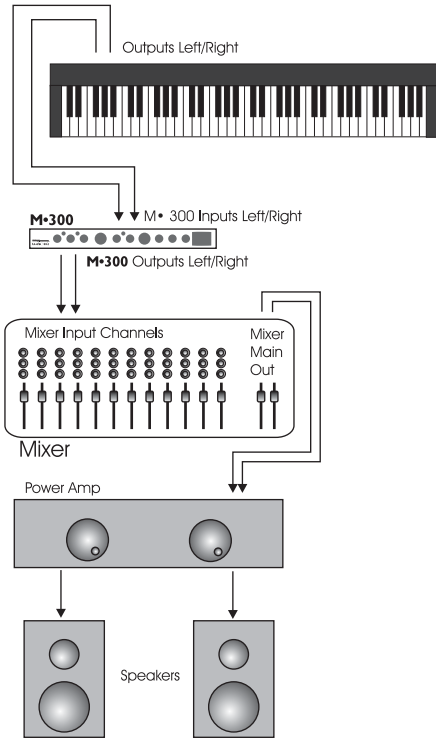

Serial Setup

This setup utilizes the M300 as a Multi-effects processor connected in serial to a Reverb. It is ideal when you wish to add Reverb to a signal already processed by one of the Multi-effects. The illustrated setup is a typical live instrument setup.

- On the rear panel select SERIAL routing by leaving the switch in "OUT" position.
- Connect Line signal directly from your instrument or from a DI-box to the M300 Inputs. (use Left Input for mono signals).
- Connect the M300's Left and Right Outputs to mixer or amplification.
- Set Input level to 12 o'clock position.
- Set MIX level to 12 o'clock position.
- Set BALANCE to 12 o'clock position.
- Adjust/fine-tune the M300 Input level so the Input LED on the front panel often is Orange but only rarely peaks at Red color.
- Select Reverb type and Multi-effect type using the selectors on the front panel.
- Now fine-tune:
 - MIX between wet and dry signal
 - BALANCE between the two effect Engines.

M300 Routing Schematic



TYPICAL SETUPS

Setup

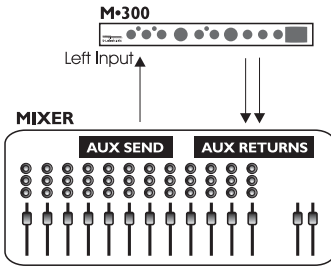

Routing Schematic

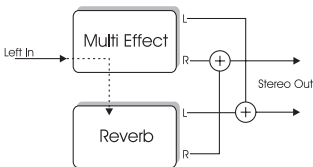

“Parallel Setup” (analog Input only)

This setup utilizes the M300 as a Dual processor on a mono signal with a common stereo Output.

- On the rear panel select Dual S/R routing by leaving the ROUTING switch in the “IN “ position.
- Connect AUX1 (or any) to Left Input. NO connections to Right Input. The Left Input signal is automatically fed to the Right Input internally in the M300.
- Connect the M300 Left and Right Outputs to the Stereo AUX L/R returns of either AUX 1 or AUX 2.
- Set MIX to 100% wet, as you in this setup do not want the direct signal to pass through the M300.
- Set Input level to 12 o'clock position.
- Set BALANCE to 12 o'clock position.
- Select Reverb type and Multi-effect type using the selectors on the front panel.
- Set the AUX Return level on the mixer to approx. 50%.
- Now slowly turn up the AUX Sends
- Adjust/fine-tune the M300 Input level so the Input LED on the front panel often is Orange but only rarely peaks at Red color.

Controlling M300 via MIDI

Various functions in the M300, such as preset recall and Tap Tempo, can be controlled via an external MIDI device.

This example shows how to control the M300 with a TC Electronic G•Minor* footcontroller. A complete list of CC values can be found on page 31.

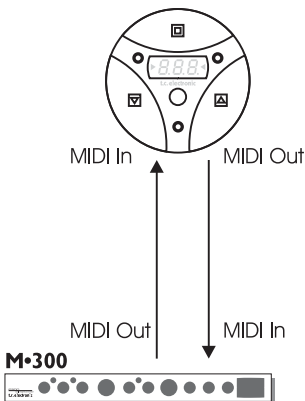

- Connect MIDI Out on the G•Minor to MIDI In on the M300.
- Connect MIDI Out on the M300 to MIDI In on the G•Minor.

You are now able to recall the stored presets in the M300 using the UP/DOWN switches on the G•Minor. You can also tap the Global Tempo using the HOLD switch.

* Detailed information on the G•Minor can be found in the G•Minor manual. Feel free to download from www.tcelectronic.com

TYPICAL SETUPS

Setup

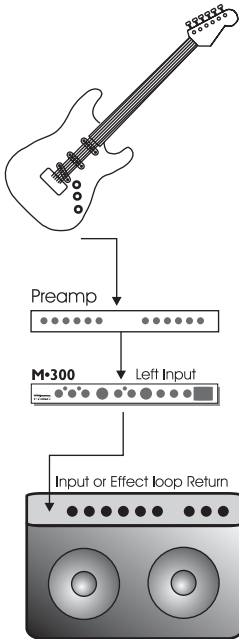

Guitar Setups

This setup utilizes the M300 as a Multi-effects processor connected in serial to a Reverb. It is ideal when you wish to add Reverb to a signal already processed by one of the Multi-effects.

This is a typical guitar setup.

- On the rear panel select SERIAL routing by leaving the switch in the "OUT" position.
- Connect guitar to preamp Input.
- Connect preamp Output to M300 Left Input.
- Connect M300 Left Output to Input on your amp. Use the regular Input or the Return on an effect loop if you use Combos or Heads. If you are using a regular Power-amp and speakers simply use the Inputs.
- Set Input level to 12 o'clock position.
- Set MIX level to 12 o'clock position.
- Set BALANCE to 12 o'clock position.
- Adjust/fine-tune the M300 Input level so the Input LED on the front panel often is Orange but only rarely peaks at Red color.
- Select Reverb type and Multi-effect type using the selectors on the front panel.
- Now fine-tune:
 - MIX between wet and dry signal
 - BALANCE between the two effect Engines.

Setup

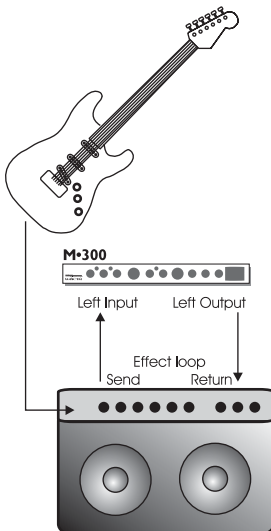

M300 in an effects loop

- On the rear panel select SERIAL routing by leaving the switch in "OUT" position.
- Connect guitar to amp Input.
- Connect effect-loop send to M300 Left Input.
- Connect M300 Left Output to Effect-loop Return.
- Set Input level to 12 o'clock position.
- If the effects loop is serial type (see owners manual for the amp) set MIX level to 12 o'clock position. If the effects-loop is parallel type set MIX to 100% (fully clockwise position).
- Set BALANCE to 12 o'clock position.
- Adjust/fine-tune the M300 Input level so the Input LED on the front panel often is Orange but only rarely peaks at Red color.
- Select Reverb type and Multi-effect type using the selectors on the front panel.
- Now fine-tune:
 - BALANCE between the two effect Engines.

TYPICAL SETUPS

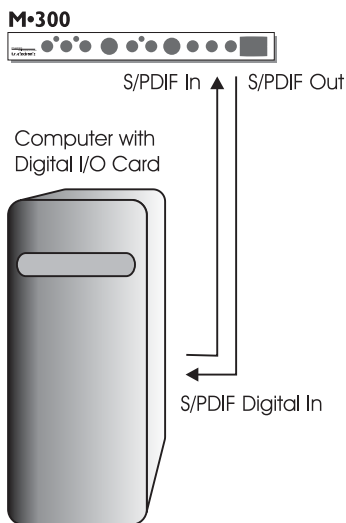

Digital Setup - M300 as Insert

This setup is ideal if you are using the M300 as a digital insert effect on your harddisk recording system.

This setup requires that you are using an I/O card with S/PDIF In/Out.

- Select Serial Routing by leaving the ROUTING switch on the rear panel in Out position.
- Connect the M300 S/PDIF digital Out to the Digital Input on your soundcard.
- Connect the Digital Out on your soundcard to the Digital In on the M300.
- Set your Soundcard to act as Master clock. There can be different names for this setting but "Internal Clock", "Internal Sync" or "Master" are commonly used phrases. (This is probably setup via your harddisk recording program. Please refer to owners manual)
- Press the DIGI IN button on the M300.
- If the DIGI IN LED is green, the M300 is locked correctly on the Digital Input signal.
- If the LED is flashing Digital In is selected but no digital signal is received within 5 seconds or the signal is corrupt. The M300 automatically returns to internal clock and analog operation but will continue to look for digital signal and the DIG IN LED on the front panel will keep blinking. Check cables and make sure that your Soundcard is set as Master.
- Once setup you can use the M300 as a plugin on your harddisk recording mixer.

TYPICAL SETUPS

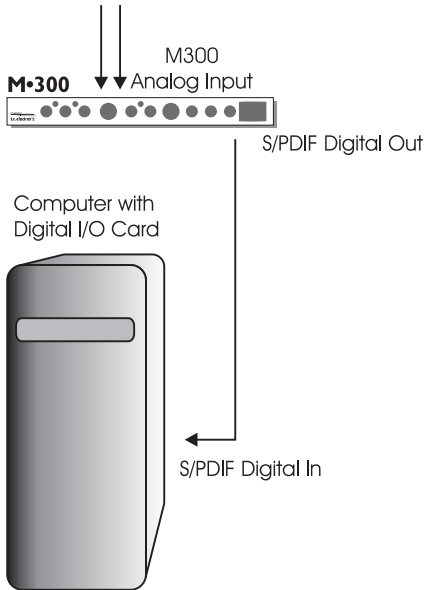

Digital Setup

- M300 as A to D converter

The analog to digital converters in the M300 are superior to most converters used on soundcards in the affordable price range. You can therefore most likely benefit from using the M300 as an A to D converter when doing harddisk recordings.

Feed the M300 with an analog Input e.g. from your mixer or Instrument line signal, and you are feeding a high quality digital signal to the harddisk.

If you wish you can of course add effects to the tracks while recording but the essence of this setup is to get best possible A to D conversion by skipping the A to D converters on your soundcard.

- Select Serial or Dual S/R Routing via the ROUTING switch on the rear panel. Note that if you do not add effects to the tracks while recording and uses Bypass mode you must use Serial routing.
- Feed any analog signal to the analog Input on the M300.
- Connect the M300 S/PDIF digital Out to the Digital Input on your soundcard.
- The M300 must act as Master clock in this setup and you must therefore set your Soundcard to act as Slave. There can be different names for this setting but "External Clock", "External Sync" or "Slave" are commonly used phrases. (This is probably setup via your harddisk recording program. Please refer to owners manual).
- For pure A to D conversion with no effects added, both Effect Type Selectors should be set to Off.
- Adjust Input level gain using the INPUT level knob.

OPERATING - INPUT/OUTPUT SECTION

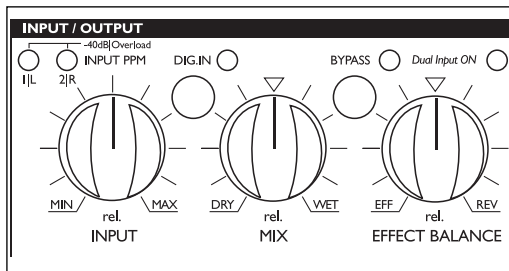

INPUT

This knob controls the Input level for both the Analog and Digital Input options. For optimal performance of the M300 a well-adjusted Input level is essential.

Analog Input Range

Counter Clockwise : -10dB
Center : 0dB
Clockwise : +14dB

Digital Input Range

Counter Clockwise : -18dB
Center : 0dB
Clockwise : +6dB

1/L - 2/R INPUT LEDs

These LEDs signal with three colors.

Green : Indicating that you are "well on the safe side"
Yellow : Reaching optimal performance.
Red : Should only occasionally blink at absolute peaks in the material you feeding the M300 with.

The Input knob adjusts the level for both Left and Right Input channels. If there is a significant difference between the Input of the Left and Right channels you should adjust the Output of the device feeding the M300.

DIG. IN

The M300 has analog as well as digital Input options. The digital Input is the S/PDIF type connected via RCA phono cables. To select/deselect the Digital Input press the DIG IN button once.

The green LED next to the DIG IN button will indicate various situations.

LED Off

Digital Input is set to Off. The M300 processes only the signal present on the Analog Inputs. This is done on an internal Sample Rate of 44.1kHz.

LED Green

The M300 is locked correctly on the Digital Input signal. With the digital signal a clock is supplied. The M300 can lock on either a 44.1 or a 48kHz Sample Rate frequency which are the most commonly used Sample Rate frequencies. E.g. a regular CD is 44.1kHz.

Flashing LED

If Digital In is selected but no digital signal is received or the signal is corrupt the M300 automatically returns to internal clock and Analog operation. However, the M300 will continue to look for digital signal on the S/PDIF Input and this is indicated by the flashing LED. If you wish to stay in analog mode press DIG IN once and the LED will stop flashing.

Dual S/R On - LED

When this LED is lit (green) it is indicated that the Dual Send/Return Routing is selected via the switch located on the rear panel. Read more about the Dual Send/Return mode on page 22-23.

OPERATING - INPUT/OUTPUT SECTION

MIX

Sets the mix between dry and wet signal. The Mix parameter operates differently depending on the selected routing:

In "Dual S/R" Routing, "Mix" controls the overall wet/dry mix of both the Multi-effect and the Reverb section.

In "Serial" Routing, "Mix" functionality in the "Effects" section depends on the selected effect.

BYPASS

The Bypass function operates differently depending on the selected routing.

Dual Send/Return routing:

Bypass key operates as a Mute function.

Serial routing:

Here the Bypass function simply passes the source signal unprocessed to Output.

EFFECTS BAL.

Sets the balance between the two Engines.

Both Engines have maximum Output in 12 o'clock position.

Fully clockwise or counter-clockwise settings can be considered as 100% bypass of one of the Engines.

THE MULTI-EFFECTS ENGINE

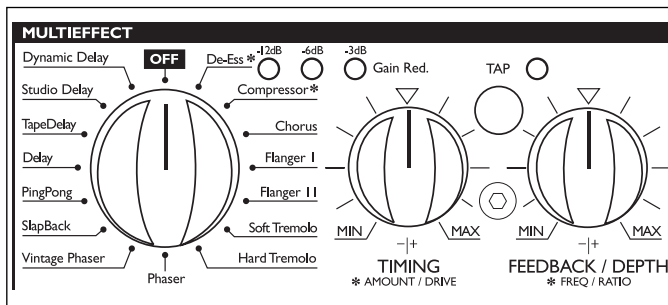

Multi-Effects Engine

Effect Selector

With the EFFECT selector you select between one of the following effects and Off.

- Dynamic Delay
- Studio Delay
- Tape Delay
- Delay
- Ping Pong
- SlapBack
- Vintage Phaser
- Phaser
- De-Esser
- Compressor
- Chorus
- Flanger 1
- Flanger 2
- Soft Tremolo
- Hard Tremolo
- Off

-12dB, -6dB, -3dB Gain Reduction LEDs

These LEDs indicate the applied Gain reduction in the Compressor and De-Esser algorithms.

TAP key and TIMING knob

Delay Effects:

The tempo of the Delay effects is set using both the TAP key and the TIMING knob.

By tapping the TAP key you set a "global tempo" that you can increase/decrease using the TIMING knob that operates as a multiplier in the Delay algorithms.

The range of the TIMING knob is 0.5 to 2.

Example

Let us say that you tap quarter notes in tempo 120BPM using the TAP key. With the TIMING knob in 12 o'clock position you now have a Delay time off 500ms*.

If you turn the TIMING knob fully counter-clockwise the actual Delay time will be
 $0.5 \text{ times } 500\text{ms} = 250\text{ms}$

If you turn the TIMING knob fully clockwise the tempo will be:
 $2 \text{ times } 500\text{ms} = 1000\text{ms} \text{ (1 second)}$

When powering up the M300 the default Tempo is 120BPM, but as explained above the position of the TIMING knob defines the actual tempo.

*The nature of a Slapback Delay is very short Delay times and the range of this Delay type is therefore much shorter.

THE MULTI-EFFECTS ENGINE

TIMING knob - De-Ess and Compression:

For the De-Ess algorithm the TIMING knob controls the Amount parameter.

For the Compressor algorithm the TIMING knob controls the Drive parameter.

TIMING knob - Chorus, Flanger, Phaser and Tremolo:

Increases/decreases the Tempo.

Remember that the default setting suggested by TC Electronic is achieved by setting the knob in 12 o'clock.

FEEDBACK/DEPTH

- FREQUENCY/RATIO knob

This knob changes functionality with the selected algorithms.

The knob controls the Feedback parameter in:

All Delays

The knob controls the Depth parameter in:

Chorus

Flanger

Phaser

Tremolo

The knob controls the Frequency parameter in:

De-Ess

The knob controls the Ratio parameter in:

Compressor

For further details on these parameters please read the Multi-effects chapter on pages 24-27.

THE REVERB ENGINE

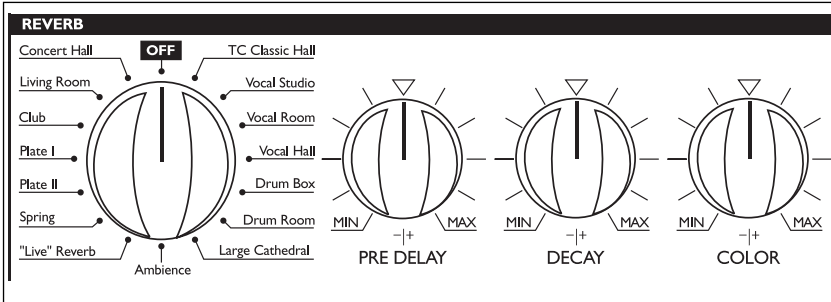

Reverb Engine

Reverb Selector

Select between the following Reverb types or "Off".

- Concert Hall
- Living Room
- Club
- Plate I
- Plate II
- Spring
- "Live" Reverb
- Ambience
- Classic Hall
- Vocal Studio
- Vocal Room
- Vocal Hall
- Drum Box
- Drum Room
- Large Cathedral
- Off

To hear the carefully designed default settings for each of the Reverb types set PRE DELAY, DECAY and COLOR knobs in "12 o'clock" position (neutral). Then adjust and fine-tune to the given application.

It is worth noticing that the range of each of these parameters will vary from algorithm to algorithm.

As an example it is possible to set a much longer Decay time for a Classic or Concert Hall Reverb than for a Drum Box.

Pre Delay

A short Delay placed between the direct signal and the Reverb Diffuse Field. By using Pre Delay the source material is kept clear and undisturbed by the more diffuse Reverb Field arriving shortly after.

Decay

The Decay parameter determines the length of the Reverb Diffuse Field. The length is defined as the time it takes for the Reverb to decay approximately 60dB.

Color

Varies the "color" of the Reverb. From dark to crisp and bright the Color parameter can really change the characteristics and style of the Reverb.

STORE - RECALL & M300 THE DISPLAY

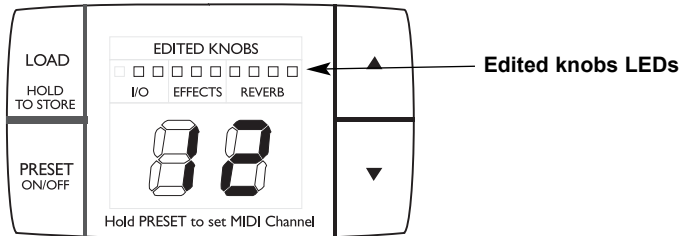

Preset Modes

The M300 holds two significantly different modes. To toggle between these modes press the PRESET ON/OFF key.

“Preset On” mode

In this mode it is possible to load any of the previously stored presets.

The “Preset On” mode is active when the display shows location numbers from 1 to 99.

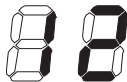

If you try to load a preset from a location where no preset is stored - no action will take place.

“Preset Off” mode

In Preset Off mode the M300 will process the signal according to the position of the front controls. A “what you see is what you hear” - setting.

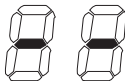

Once you have accessed the Preset Off mode and return to the Preset On mode the preset number will blink indicating that you must press LOAD to recall the settings stored with that particular preset.

Display

Edited knobs LEDs

(relevant only in Preset ON mode)

These LEDs refer to the 10 front panel controls. See illustration above.

They indicate when the front controls do not match the current settings of the active preset.

When you turn any of the knobs and pass the position physically matching the current parameter value, the parameter is “grabbed”, the LED goes off and you can adjust the parameter.

Load/Store Presets

Load User Preset

- Enter “Preset On” mode using the PRESET ON/OFF key. The M300 is in Preset On mode when the display shows location-numbers 1 to 99.
Use the UP/DOWN arrows to select desired preset (1-99).
- The digits are now blinking to indicate that you are previewing the preset and it has not yet been recalled.
- Press LOAD to recall the preset and the digits are now steady.

Store User Preset

- Enter “Preset On” mode using the PRESET ON/OFF key. The M300 is in Preset On mode when the display shows location-numbers 1 to 99.
- Use the UP/DOWN arrows to select desired preset location where you intend to store the preset (1-99).
- The digits are now blinking to indicate that you have not yet stored the preset.
- Press the LOAD (HOLD TO STORE) key for approx. 2.5 seconds until the digits turn steady.

MISCELLANEOUS

Factory Presets

The M300 holds no conventional factory presets. When all the controllers are in 12 o'clock position the M300 is in "neutral", meaning that all parameters are set as suggested by TC Electronic. Combining the 16 positions of both the Multi-effect and Reverb selectors you actually have 256 "factory" presets.

MIDI CH.

Via an external MIDI device it is possible to recall presets and control parameters in the M300. For the external device to communicate with the M300 it is essential that they communicate on the same MIDI Channel. The M300 can be set to receive on all MIDI channels, none or all.

- Press and hold PRESET ON/OFF. The current selected MIDI channel is displayed.

Assuming the M300 is "right out of the box" or that you have performed a Reset procedure as described on page 31, the display now shows:

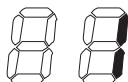

- indicating that channel 1 is selected and the M300 can receive MIDI information on channel 1.

- Use the UP/DOWN arrows to select MIDI channels 1 to 16.
- "O" indicates Omni which means that the M300 can receive MIDI information on all channels.
- "OF" indicates that the M300 will ignore any incoming MIDI messages.
- Press LOAD to verify and exit menu.

SysEx ID

The M300 SysEx ID is always identical with the set MIDI Channel.

Application Software version

This number indicates the current loaded application software and is relevant only for servicing purposes.

- Press and hold PRESET ON/OFF and use the UP/DOWN arrows to select "AP" as displayed below.



The display will flash between "AP" (for application) and the current loaded application software.

Front Software version

This number indicates the current loaded front software and is relevant only for servicing purposes.

- Press and hold PRESET ON/OFF and use the UP/DOWN arrows to select "Fr" as displayed below.

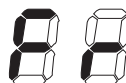

The display will flash between "Fr" (for front-software) and the current loaded front software number.

ROUTINGS

It is essential that you have selected the correct routing according to your setup:

Serial Routing

With this routing the two Engines are used as a line of two effects where the signal first passes the Multi-effects Engine and thereafter the Reverb Engine.

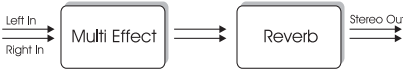

This is the Routing to select when you want to add reverb to a signal after the signal is processed by the Multi-Effects Engine. On the rear panel you select Serial Routing and you should connect the M300 according to this illustration:

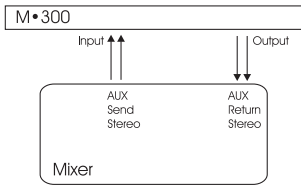

Dual Send/Return

By routing two different signals to the two effect Engines you can utilize the M300 as two separate effect units with a common Output.

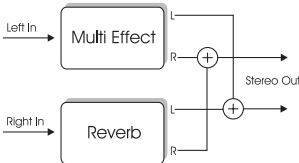

Use this if you e.g. wish to use the M300 to add Delay to a guitar on one channel and Reverb to a vocal on another channel.

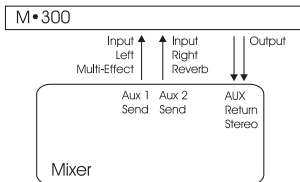

Parallel Routing (analog Input only)

This routing gives you the opportunity to have two effects in parallel on a single mono signal.

- Select Dual Inputs Routing by leaving the ROUTING switch on the rear panel in "In" position.
- Connect a mono signal to Left Input.

The Input signal is now split and fed to both the Multi-effects Engine and the Reverb Engine. Both Engines then uses Left and right Outputs as common Outputs.

Signal Flow:

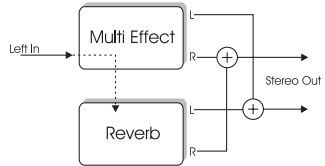

Connect the M300 according to this illustration:

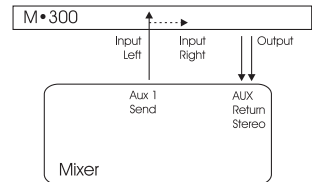

Also see Setup examples on pages 10 to 15.

MULTI-EFFECTS

This manual section explains the function of the front panel controls as well as the algorithm parameters in the Multi-effects section.

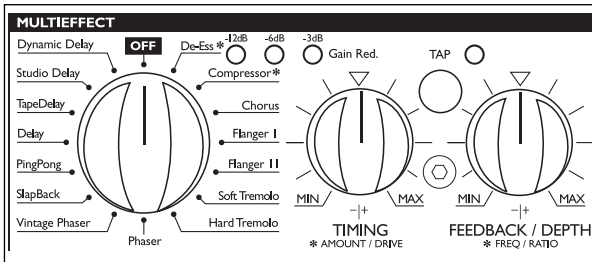

Delay - controls

TIMING knob

Both the TIMING and the TAP keys are used to specify the desired tempo of the repeats.

A tempo is tapped on the TAP key and with the TIMING knob you multiply this tempo. The range of the TIMING knob is 0.5 to 2. See example below

FEEDBACK knob

The FEEDBACK knob sets the number of Delay repeats. Leaving the knob in 12 o'clock position gives you the starting point suggested by TC Electronic.



When powering up the M300 the default Tempo is 120BPM, but as explained the position of the TIMING knob defines the actual tempo.

You should also note that the range varies depending on the selected Delay type. E.g. - as a short Delay time is what defines a Slapback Delay, the range is considerably lower than in any other Delay algorithm.



When using the M300 in a Dual Send/Return setup the MIX knob should be set to 100% wet.

Example - TIMING knob

Let us just explore the Tap Tempo and Timing functions a bit further:

With a Studio Delay algorithm selected you tap quarter notes in tempo 120BPM using the TAP key. With the TIMING knob in 12 o'clock position you now have a Delay time of 500ms.

If you turn the TIMING knob fully counter-clockwise the actual Delay time will be:
 $0.5 \text{ times } 500\text{ms} = 250\text{ms}$

If you turn the TIMING knob fully clockwise the tempo will be:
 $2 \text{ times } 500\text{ms} = 1000\text{ms} \text{ (1 second)}$

Delay Types

Dynamic Delay

The Dynamic Delay initially introduced in the well-recognized TC 2290, is a function that allows the Delay Output level to be actively altered by the dynamics of the Input level. The basic idea is to have a lower level of the Delay repeats while the instruments are played (or vocals are sung) and an increased level of Delay when no Input is present.

A function that leaves the source material clear and undisturbed while played and delicately accompanied by the Delay between phrases. With the correct settings you will be amazed how you can use Delay effects on material where you previously never considered this an option.

MULTI-EFFECTS

Tape Delay

This algorithm emulates the old style Tape Delays. Before the Digital era Delays were created using a Tape Recording device with a tape-loop and recording/playback heads. As you probably know analog tape-recorders has a tendency to deteriorate/change the recorded material. Wow and flutter combined with a significant loss of high-end frequencies, and to some extent also low-end frequencies, are all elements commonly associated with tape recordings. However, these features are at times quite useful and sought-after as they in some situations blend with and compliments the source material in a highly musical manner. Among other things the M300 Tape Delay uses a HiCut with a rather low Cross-over frequency to emulate the loss of highs found on conventional Tape delays.

Compare this to the clean Studio Delay algorithm, which has a considerably higher HiCut frequency to see what fits your application.

Studio Delay

As opposed to the Tape Delay algorithm described above the Studio Delay algorithm will give you a clearer reproduction of the material fed to the M300. To soften the Delay as it is commonly done in studio productions the Studio Delay uses a subtle yet significant HiCut at a relatively High crossover frequency.

Delay

Standard Delay. The M300 processing power and excellent 24 bit converters will process a precise high quality Delay with no deterioration of the sound.

PingPong Delay

The PingPong Delay basically pans the Delay repeats from left to right and back while keeping the Input signal at its original position. This gives a very wide spread special effect.

Slapback Delay

Slapback Delay is a very short Delay with only a single or a few repeats. The effect is commonly used as a "doubling-effect" making the processed material seem more massive. Short Slapback Delays are also often used on funky rhythm guitars, - a bit longer on Rockabilly guitar or vocals.

Phaser

Phaser and Vintage Phaser

The Vintage Phaser utilizes four all-pass filters. These filters create comb-looking characteristics. When the filtered sound is mixed with the direct sound the "phasing sound" occurs.

The Standard Phaser utilizes twelve all-pass filters. Due to the higher number of filters in the Smooth Phaser, compared to the Vintage Phaser, the Standard Phaser simply sounds smoother than the Vintage type.

Phaser - controls

TIMING knob

In the Phaser algorithm the TIMING knob sets the Speed of the Phaser.

FEEDBACK/DEPTH knob

In the Phaser algorithm the FEEDBACK/DEPTH knob sets the Depth of the Phasing effect.

Hard Tremolo/Soft Tremolo

A Tremolo is basically a repeated level change controlled by an LFO. The M300 offers a Hard Tremolo that used a "square" wave-shape and Soft Tremolo that use a "triangular" wave shape. Please see the illustration below. The difference is quite obvious. Listen and enjoy!

Hard Tremolo - Square shape



Soft Tremolo - Triangular shape



Tremolo - controls

TIMING knob

In the Tremolo algorithm the TIMING knob sets the Speed of the Tremolo.

FEEDBACK/DEPTH knob

In the Tremolo algorithm the FEEDBACK/DEPTH knob sets the Depth of the Tremolo effect.

Chorus and Flanger

A Chorus/Flanger is basically a short Delay that is modulated by an LFO (Low Frequency Oscillator). The difference between Chorus and Flanging is the applied Delay time and the Feedback parameter in the Flanger.

The modulation of the short Delay gives very small variations in pitch. These pitch changes blended with the direct sound gives you the Chorus/Flanger sound.

A Chorus effect is typically used as a smoothing effect where the Flanger is more in the genre of "special effects".

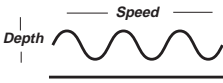

Flanger 1 and Flanger 2

The difference lies in a few fixed settings. Flange 2 is more intense due to a higher Feedback setting, a lower HiCut setting and a higher Delay setting.

Chorus/Flanger - controls

TIMING knob

In the Chorus/Flanger algorithms the TIMING knob sets the Speed of the effect.

FEEDBACK/DEPTH knob

In the Chorus/Flanger algorithm the FEEDBACK/DEPTH knob sets the Depth of the effect.

Compressor

Before explaining how the M300 Compressor operates a little background information on compression in general could be useful.

Background

A Compressor is basically used to reduce the dynamic content of a signal. When the signal is above the set Threshold the Compressor starts to reduce the Output level according to the set Ratio. With a reduced dynamic range a signal is much easier to further control and will have a more precise and "fixed" appearance in any audio production.

Illustration:

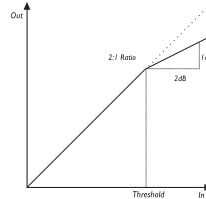

Compression is a powerful tool. Correct amount of compression applied on specific instruments will create a homogen well-defined result. Too much compressing applied will generally give an un-dynamic, less musical and flat result.

Parameters associated with Compression

Threshold

As soon as the Input signal is above the set Threshold point the Output level of the Compressor will be reduced by the specified Ratio.

Ratio

Specifies how aggressive the gain reduction of the signal should be. With a ratio setting of e.g. 4:1- for every 4dB that is above the Threshold point only 1 is passed to the Output.

Attack

Specifies how fast the gain reduction specified by the Ratio parameter should be applied. The Attack parameter in the M300 Compressor is fixed.

MULTI-EFFECTS

Auto Make-up gain

Since the Output of the signal above the set Threshold point is reduced the entire signal will appear to be at a lower volume. In many Compressors and also in the Compressor type used in the M300, Auto Make-up gain will compensate for this loss of gain. This way the Output level is kept and only the dynamic range is changed.

The M300 Compressor

For optimal “ease of use” we have simplified and reduced the conventional Compression controls into the following controls:

Drive (TIMING KNOB)

The higher the Drive setting is, - the lower the Threshold point is set and the harder you will “hit” the Compressor. In other words: The higher Drive setting, the more compression is added.

Ratio (FEEDBACK/DEPTH KNOB)

This parameter sets the amount of gain reduction of signal above the “Threshold” - see Drive parameter.

De-Esser

A De-Esser is a compressor type used to reduce only specific sibilant frequencies. Typically the “s” sounds can be far too dominant in a vocal track and the track would therefore often benefit from being processed by a De-Esser.

De-Esser Controls

Amount (TIMING KNOB)

Sets the amount of gain reduction around the Frequency specified by the Frequency knob.

Frequency (FEEDBACK/DEPTH KNOB)

Sets the Frequency around which you would like to reduce frequencies.

REVERBS

The M300 holds the following Reverb types:

- Concert Hall
- Living Room
- Club
- Plate I
- Plate II
- Spring
- “Live” Reverb
- Ambience
- Classic Hall
- Vocal Studio
- Vocal Room
- Vocal Hall
- Drum Box
- Large Cathedral

Each of these Reverb types are created and fine tuned by the highly experienced staff at TC Electronic and utilizes the vast experience we have accumulated over the past years of producing high quality Reverbs. Though the M300 is a very compact effects unit in the affordable price range there is no compromise when it comes the Reverb quality.



To get best starting points for your application set the three controls in the Reverb section in 12 o'clock position and “take a trip” round the different Reverb types.

By leaving the controls in 12 o'clock position you will hear our suggested settings for each Reverb type. Once you have the Reverb type closest to your goal start twisting the controls.

Pre Delay

A short Delay placed between the direct signal and the Reverb Diffuse field. By using Pre Delay the source material is kept clear and undisturbed by the more diffuse Reverb Diffuse Field arriving shortly after.

Decay

The Decay parameter determines the length of the Reverb Diffuse Field. The length is defined as the time it takes for the Diffuse Field to decay approximately 60dB.

Color

Varies the “color” of the Reverb. From dark to crisp and bright the Color parameter can really change the characteristics and style of the Reverb. Try it!

Perception of Reverb types may vary from person to person. It is a rather subjective issue to discuss, describe or even define. However, over the years a general perception of basic Reverb types has evolved. From these definitions the experienced sound-engineer chooses and is given good starting points for various applications. We choose to briefly describe the Reverb types found in the M300 like this:

TC Classic Hall

The TC Classic Hall simulates a rather large Hall and preserves the natural characteristics of the source material.

This is excellent for many studio applications requiring medium to long Decay times and especially on vocal material.

Concert Hall

Compared to the TC Classic Hall the Concert Hall is a more diffuse Reverb type. This type of Reverb is often used on drums and other percussive material. We are still talking a simulation of a rather big facility.

Vocal Room - Vocal Studio - Vocal Hall

The three types all simulates typical vocal recording facilities. The Vocal Studio and Vocal Room types are medium sized locations. They give the soft type of reflections usually associated with wooden surfaces.

The Vocal Hall is a larger location than the above but still with the soft characteristics of wooden surfaces.

Drum Box - Drum Room

Reverbs especially designed to emulate the typical recording rooms used for drums.

The Drum Box is a 80's style ambient room with only very short reflections.

The Drum Room emulates the reflections in a medium sized drum room with a high ceiling - giving longer but natural sounding reflections compared to the Drum Box.

Large Cathedral

Where the TC Classic Hall, and to some extent also the Concert Hall, are Reverbs with smooth diffuse fields, the Large Cathedral has a much more uneven diffused field. Emphasis on the reflections deriving from many hard surfaces and the high amount of Lo Color naturally occurring in this type of rooms, gives excellent simulation of the Large Cathedral.

REVERBS

Living Room

Directly opposite the Large Cathedral the Living Room type simulates a relatively small room well furnished. In such a room many reflections are absorbed by soft material and source material is reflected and sustained only from walls (with wallpaper) and windows and maybe a table etc.

Club

Did you ever discover the great difference of a soundcheck and the actual concert. The Club Reverb emulates a typical empty medium sized club. Try this on vocals or guitar as an effect that will put emphasis on these instruments.

Plate I and II

Before the digital era either reverberating springs or large metallic plates was used to create Reverb. The characteristics of Plate Reverbs are diffuse and bright and are still successfully used on many percussive instruments.

Spring

The Spring algorithm is designed to reproduce the sound of the old spring Reverbs, such as the ones used in vintage guitar amps.

Live

For live purposes a rather grainy and bright Reverb is needed to cut through the typical background noise at live locations. The Live Reverb is optimal when used with medium to long Decay times and will work excellent on both vocals and instruments requiring a clear and obvious Reverb.

Ambience

With focus on the Early Reflections that defines the perception of a room size, the Ambience Reverb type is typically used on dry recordings or dry drum samples to emulate a feeling of environment. Ambience and Room definition are the keywords here.

APPENDIX - MIDI IMPLEMENTATION CHART

DUAL ENGINE PROCESSOR M300 - APRIL 2002

Function		Transmitted	Recognized	Remarks
Basic Channel	Default	1	1	
	Changed	1-16	OMNI-1-16	
Mode	Default			
	Messages	X	X	
	Altered			
Note Number		X	X	
	True Voice	X	X	
Velocity	Note ON	X	X	
	Note OFF	X	X	
After Touch	Key's	X	X	
	Channel	X	X	
Pitch Bend		X	X	
Control Change		O	O	See CC list on page 31 for details. All Controllers are Single Byte type scaled to parameter range.
Prog Change		O	O	
SysEx		O	O	
Common	Song Pos	X	X	
	Song Sel	X	X	
	Tune			
System real time	Clock	X	O	MIDI TimeClock can be used to set Delay tempo.
Aux Messages	Commands	X	X	
	Local ON/OFF	X	X	
	All Notes OFF	X	X	
	Active Sense	X	X	
	Reset	X	X	

O: YES Mode 1: OMNI ON, POLY Mode 2: OMNI ON, MONO
X: NO Mode 3: OMNI OFF, POLY Mode 4: OMNI OFF, MONO

APPENDIX - MIDI CC & RESET & BULK DUMP

Via an external MIDI device sending MIDI Control Changes you are able to control the parameters listed below.

Parameter	Control Change number:
In Level	12
Mix	13
Effect Bal.	14
Digi. In	15
Bypass	81
MultiEff. Type	50
MultiEff. Off	82
Timing	16
Tap	80
Feedback	17
Rev. Type	51
Rev. Off	83
PreDelay	18
Decay	19
Color	20

MIDI Bulk Dump

By performing a MIDI bulk dump you are able to dump all presets to an external MIDI device such as a sequencer for backup.

- Press and hold the PRESET ON/OFF key approx. 2.5 sec.
- Use the ARROW UP/DOWN keys to select Bulk Dump mode.

The display will show:

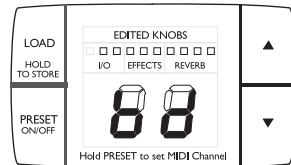

- Set the receiving device in MIDI bulk receive mode. A standard MIDI sequencer program should typically be set to record a MIDI track. (Please refer to the user manual of the receiving device).
- Now press LOAD once, and the MIDI Bulk Dump is performed.



The M300 is always ready to receive a MIDI bulk dump unless the receive MIDI channel is set to off "OF"

Reset Procedure

If you would like to do a complete reset of the M300 and return to factory settings follow this procedure:

- Power down by disconnecting the power cord.
- Press and hold TAP while reconnecting power. The display will show a flashing "R".
- Press Load to reset.
- Power off - power on.

The unit is now reset.



Be aware that all User presets will be lost when performing a factory reset!

APPENDIX - TECHNICAL SPECIFICATIONS

Digital Input and Output

Connector:	RCA Phono (S/PDIF)
Formats:	S/PDIF (24 bit), EIAJ CP-340, IEC 958
Sample Rates:	44.1 kHz. (48 kHz only @ Digital Input)
Processing Delay:	0.08 ms @ 48 kHz
Frequency Response DIO:	DC to 23.9 kHz \pm 0.01 dB @ 48 kHz

Analog Inputs

Connectors:	1/4" phone jack balanced, mono sense
Impedance, Bal / Unbal:	21 kOhm / 13 kOhm
Max. / Min. Input Level @ 0 dBFS:	+24 dBu / 0 dBu
Sensitivity Range @ 12 dB headroom:	-12 dBu to +12 dBu
A to D Conversion:	24 bit, 128 x oversampling bitstream
A to D Delay:	0.70 ms / 0.65 ms @ 44.1 kHz / 48 kHz
Dynamic Range:	typ < -92 dB, 22 Hz to 22 kHz
THD:	typ < -90 dB (0.0032 %) @ 1 kHz, -1 dBFS
Frequency Response:	+0/-0.1 dB, 20 Hz to 20 kHz
Crosstalk:	typ < -100 dB, 20 Hz to 20 kHz

Analog Outputs

Connectors:	1/4" phone jack balanced
Impedance Bal / Unbal:	40 Ohm / 20 Ohm
Max. Output Level:	+14 dBu
D to A Conversion:	24 bit, 128 x oversampling bitstream
D to A Delay:	0.68 ms / 0.63 ms @ 44.1 kHz / 48 kHz
Dynamic Range:	typ < -105 dB typ, 22 Hz to 22 kHz
THD:	typ < -97 dB (0.0014 %) @ 1 kHz, +13 dBu
Frequency Response:	+0/-0.5 dB, 20 Hz to 20 kHz
Crosstalk:	typ < -100 dB, 20 Hz to 20 kHz

EMC

Complies with:	EN 55103-1 and EN 55103-2 FCC part 15, Class B, CISPR 22, Class B
----------------	--

Safety

Certified to:	IEC 65, EN 60065, UL6500 and CSA E60065 CSA FILE #LR108093
---------------	---

Environment

Operating Temperature:	32° F to 122° F (0° C to 50° C)
Storage Temperature:	-22° F to 167° F (-30° C to 70° C)
Humidity:	Max. 90 % non-condensing

Control Interface

MIDI:	In/Out: 5 Pin DIN
Pedal:	1/4" phone jack

General

Finish:	Anodized aluminum front Plated and painted steel chassis
Display:	2 x 7 segment + LED's
Dimensions:	19" x 1.75" x 4.2" (483 x 44 x 105.6 mm)
Weight:	3.3 lb. (1.5 kg)
Mains Voltage:	100 to 240 VAC, 50 to 60 Hz (auto-select)
Power Consumption:	<15 W
Warranty Parts and labor:	1 year

Due to continuous development these specifications are subject to change without notice.