

450 Dual Zone Priority Mixer



450

User's Guide

Table of Contents

<i>Chapter 1</i>	Introduction	1
<i>Chapter 2</i>	Operator Safety Summary	2
<i>Chapter 3</i>	Fast Setup	3
<i>Chapter 4</i>	Mic/Line Inputs	4
<i>Chapter 5</i>	Stereo Line Inputs	6
<i>Chapter 6</i>	Output Zone Master	7
<i>Chapter 7</i>	Priority Override Muting	9
<i>Chapter 8</i>	Applications	10
<i>Chapter 9</i>	Troubleshooting	12
<i>Chapter 10</i>	Specifications	13
<i>Chapter 11</i>	Warranty & Service	14
<i>Appendix A</i>	Input/Output Connections	16
<i>Appendix B</i>	Declaration of Conformity	17

Rev C.00, 6 July, 1999

Symetrix part number 53450-0C00

Subject to change without notice.

©1999, Symetrix, Inc. All right reserved.

Symetrix is a registered trademark of Symetrix, Inc.

Mention of third-party products is for informational purposes only and constitutes neither an endorsement nor a recommendation. Symetrix assumes no responsibility with regard to the performance or use of these products.

Under copyright laws, no part of this manual may be reproduced or transmitted in any form or by any means, electronic or mechanical, including photocopying, scanning, recording or by any information storage and retrieval system, without permission, in writing, from Symetrix, Inc.

 **Symetrix**
14926 35th Ave. West
Lynnwood, WA 98037 USA
Tel (425) 787-3222
Fax (425) 787-3211
Email symetrix@symetrixaudio.com

450

The 450 Dual Zone Priority Mixer is designed for paging and music sound systems in clubs, restaurants, hotels, conference facilities, houses of worship or anywhere multiple audio inputs must be combined and distributed. There are two mono mic/line inputs (with phantom power and low frequency filters) and four stereo line inputs. Each input may be assigned to a stereo output zone, a mono output zone or both.

Our unique hierarchical Priority Override structure permits the two mic/line inputs and the first stereo line input to mute the other (lower priority) inputs assigned to the same zone. For example, in a typical configuration, a paging microphone assigned to the stereo zone will have priority over a background music source (connected to line input 5-6) in that zone. A jukebox (connected to line input 3-4) in the same zone will have priority over the background music, but the paging signal will retain ultimate priority and force muting of both the jukebox and the background music whenever the page mic is used.

The 450's flexibility and simplicity make it the perfect choice for a wide variety of systems. By accepting audio inputs from virtually any type of audio source and selectively routing to either the mono or stereo output zone the 450 can save you time and money in the design and installation of your next project.

Of course we recommend you read this manual cover-to-cover. You'll find the answer to most of your questions inside. If you have technical questions beyond the scope of this manual contact our Customer Service Department at:

Phone: (425)787-3222
 Fax: (425)787-3211
 Email: symetrix@symetrixaudio.com

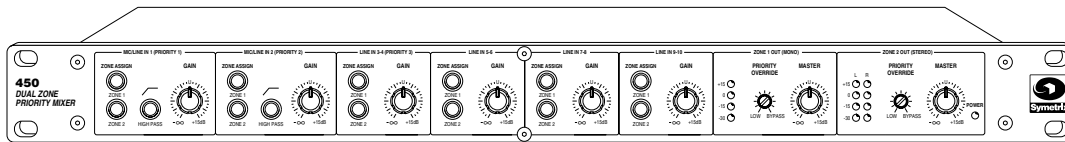

Front panel

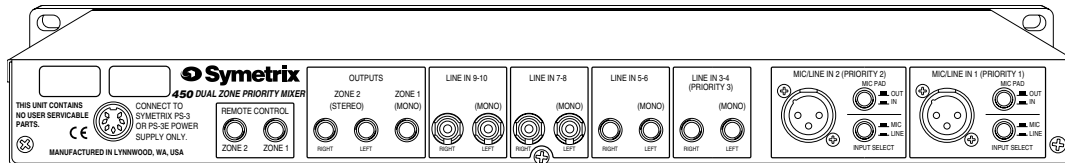

Rear panel

450

Equipment Markings

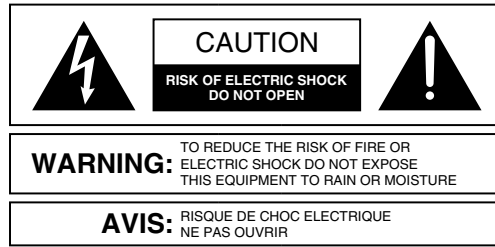

SEE OWNERS MANUAL. VOIR CAHIER D'INSTRUCTIONS.
 No user serviceable parts inside. Refer servicing to qualified service personnel.
 Il ne se trouve a l'interieur aucune piece pouvant etre reparaee l'usager.
 S'adresser a un reparateur competent.

The lightning flash with arrowhead symbol within an equilateral triangle is intended to alert the user of the presence of uninsulated “dangerous voltage” within the product’s enclosure that may be of sufficient magnitude to constitute a risk of electric shock to persons. The exclamation point within an equilateral triangle is intended to alert the user of the presence of important operating and maintenance (servicing) instructions in the literature accompanying the product (i.e. this manual).

Caution *To prevent electric shock, do not use the polarized plug supplied with the unit with any extension cord, receptacle, or other outlet unless the blades can be fully inserted.*

Terms

Several notational conventions are used in this manual. Some paragraphs may use **Note**, **Caution**, or **Warning** as a heading. Certain typefaces and capitalization are used to identify certain words. These are:

- Note** Identifies information that needs extra emphasis. A **Note** generally supplies extra information to help you to better use the 450.
- Caution** *Identifies information that, if not heeded, may cause damage to the 450 or other equipment in your system.*
- Warning** **Identifies information that, if ignored, may be hazardous to your health or that of others.**
- CAPITALS** Controls, switches or other markings on the 450’s chassis.
- Boldface** Strong emphasis.

Important Safety Instructions

Please read and keep these instructions. Heed and follow all warnings and instructions. Install in accordance with the manufacturer’s instructions.

Power Source This product is intended to operate from a power source that does not apply more than 250V rms between the power supply conductors or between either power supply conductor and ground. A protective ground

connection, by way of the grounding conductor in the power cord, is essential for safe operation.

Grounding The chassis of this product is grounded through the grounding conductor of the power cord. To avoid electric shock, plug the power cord into a properly wired receptacle before making any connections to the product. A protective ground connection, by way of the grounding conductor in the power cord, is essential for safe operation. **Do not defeat the safety purpose of the grounding plug.** The grounding plug has two blades and a third grounding prong. The third prong is provided for your safety. When the provided plug does not fit your outlet, consult an electrician for replacement of the obsolete outlet.

Danger from Loss of Ground If the protective ground connection is lost, all accessible conductive parts, including knobs and controls that may appear to be insulated, can render an electric shock.

Proper Power Cord Use only the power cord and connector specified for the product and your operating locale. Use only a cord that is in good condition. **Protect the power cord** from being walked on or pinched, particularly at plugs, convenience receptacles, and the point where they exit from the apparatus.

Operating Location Do not operate this equipment under any of the following conditions:

explosive atmospheres, in wet locations, in inclement weather, improper or unknown AC mains voltage, or if improperly fused. Do not install near any heat source such as radiators, heat registers, stoves, or other apparatus (including amplifiers) that produce heat. Unplug this apparatus during lightning storms or when unused for long periods of time.

Stay Out of the Box To avoid personal injury (or worse), do not remove the product covers or panels. Do not operate the product without the covers and panels properly installed. Only use accessories specified by the manufacturer. Clean only with a damp cloth.

User-serviceable parts There are no user serviceable parts inside the 450. In case of failure, refer all servicing to the factory. Servicing is required when the 450 has been damaged in any way, such as when a power supply cord or plug is damaged, liquid has been spilled or objects have fallen into the apparatus, the apparatus has been exposed to rain or moisture, does not operate normally, or has been dropped.

450

If you're in a hurry to get the 450 into your sound system and don't have time to thoroughly read this manual, the following steps will probably be enough to get you started:

- 1 Turn all front panel gain controls down.
- 2 Make sure all Zone Assign buttons are OUT.
- 3 Connect the 450 to AC power.
- 4 Set all back panel switches in correct position. Take extra care to set the Mic/Line switch (found on Inputs 1 and 2 only) in the appropriate position.
- 5 Connect all the audio inputs and outputs you need.
- 6 Set BOTH Priority Override adjustments to BYPASS. To use this feature, see Priority Override Muting in the Operations section of this manual.
- 7 Assign the inputs to appropriate zones, set the Zone Out Master to 12:00 (unity gain), and turn up each input until the sound source is at the desired loudness.
- 8 Now read the rest of this manual.

450

Front Panel

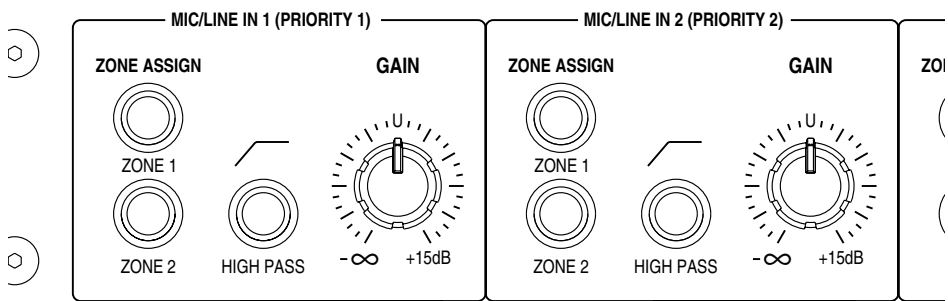

Zone Assign - Any input can be assigned to either the mono or stereo output zone, or both, or neither. When either Mic/Line input is assigned to the stereo output zone, both left and right will be driven by the same signal. For the best signal to noise performance, leave the input unassigned if not in use.

Highpass Filter - 12dB/Oct LF rolloff. 3dB down at 115 hz. Use this to eliminate excessive “p-popping” or room rumble from paging/announce mics. Even if you don’t notice a problem, try pushing this switch anyway. It increases the efficiency of systems using ceiling mounted speakers of the 70V variety, because it removes low frequency material that the speakers probably can’t reproduce anyway. It will help your amplifier to run cooler, draw less power, and just maybe it will help to extend the life of the speaker.

Channel Gain Control - Gain range is $-\infty$ to +15dB. Unity gain (indicated by the “u” symbol on the front panel) at 12:00 position. This is no ordinary volume control. Well, actually it is.

450

Rear Panel

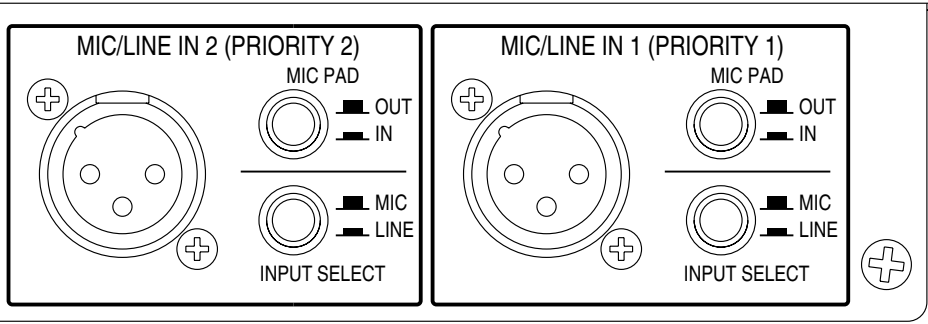

XLR Input Jack - In order to fit all the inputs and outputs onto the 450's rear panel, we combined the Mic/Line Input jacks into one balanced XLR connector that can handle both. This jack is wired as follows:

Pin 1 = (ground, shield)

Pin 2 = (high, +)

Pin 3 = (low, -)

Most low impedance, balanced microphones (and many line level sources) can plug directly into these jacks, but some sources will require adapters. See the chart in Appendix A for examples.

Caution *Do not attempt to connect a high impedance, unbalanced microphone (these usually, but not always, have a 1/4" phone jack attached to them) to either Mic/Line input unless you first disconnect the phantom power.*

INPUT SELECT Switch - Push this switch in to accommodate line level sources such as PBX paging outputs, mixing consoles, automated emergency announce systems, etc. This bypasses the mic preamp circuit and disconnects phantom power from the XLR connector.

Note Make sure the Mic/Line input is not assigned to either Zone Output when you push the Mic/Line switch because the phantom power may cause a slight pop.

In the mic (out) position, the input signal is routed through the mic preamp and the phantom power is engaged. The preamp stage delivers approximately 40 dB of gain.

Warning **Do not put this switch into the Mic position when feeding a line level signal into this input** (unless you enjoy re-coning speakers).

MIC PAD Switch - This decreases the gain of the mic preamp by 20 dB. Engage this switch if the mic level signal source tends to overload the input preamp stage, or you notice that the incoming signal is so hot that you have to run the Channel Gain knob really low. Typically, this happens when using high output condenser mics, or handheld, close-talked mics. As the name Mic Pad suggests, this switch does not affect the input gain when the channel is operating in Line mode.

Phantom Power - Phantom power is applied to the Mic/Line input only when the mic/line switch is in the mic (in) position. If you want to completely disconnect the phantom power, please contact Symetrix Customer Service.

450

Front Panel

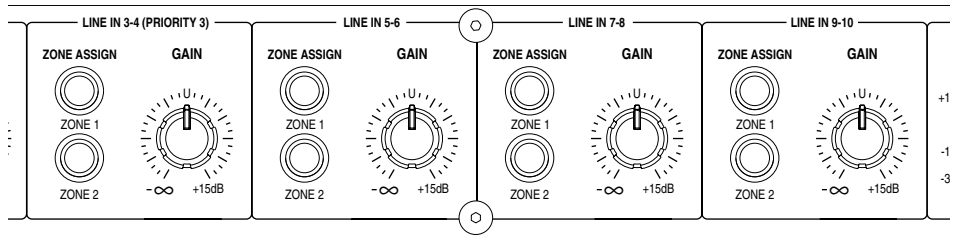

Zone Assign - As you might expect, the Left and Right input signals are summed when fed to the Zone 1 (mono) output. This is done independently of the Zone 2 (Stereo) feed, which keeps the signals separate. As with the Mic/Line inputs, maximize the unit's signal-to-noise ratio by leaving all unused inputs unassigned.

Channel Gain - The wide gain range of this control ($-\infty$ to +15dB) accommodates the variety of input levels generically known as "line level", including tape decks, CD players, console feeds, etc. Unity gain is indicated by the "u" symbol on the front panel.

Rear Panel

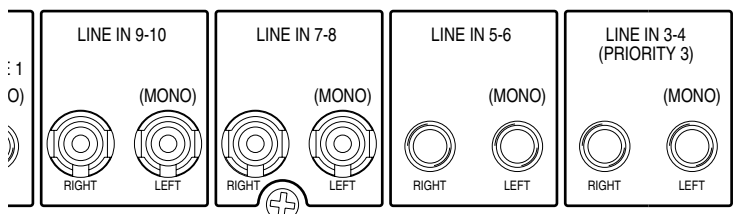

Input Jacks - Line inputs 3-6 are equipped with 1/4", TRS (tip-ring-sleeve), balanced, phone jacks. They are wired as follows:

- Tip = (high, +)
- Ring = (low, -)
- Sleeve = (ground, shield)

Line inputs 7-10 are unbalanced RCA-phono type jacks. They are wired as follows:

- Tip = (high, +)
- Sleeve = (ground, shield)

Though you'll be able to plug most line level outputs directly into the 450, some sources may need adapters. See Appendix A for proper wiring.

Mono/Stereo Operation - Line Inputs 3-10 are arranged in stereo pairs; each pair is assigned to a single gain control on the front panel. If you want to use one of these inputs with a mono source, just insert a single plug into the jack labeled Left (mono) and leave the Right jack unconnected. The left jack will automatically feed both the left and right channels of the Zone 2 (stereo) output.

450

Front Panel

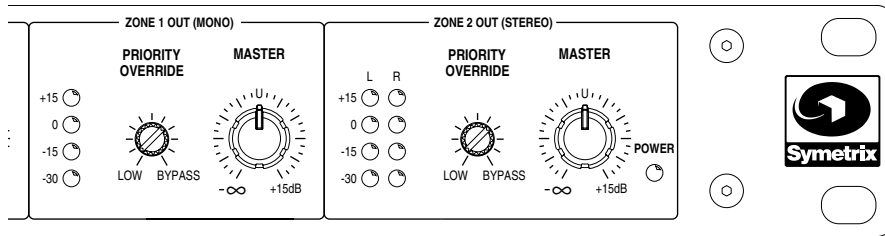

Output Jacks - The 450's outputs are electronically balanced, low-impedance, and capable of driving a balanced input to +22dBu. The output connectors are 1/4" Tip-Ring-Sleeve and you can find wiring and adapter examples in Appendix A.

Master Gain Controls These controls have the same gain range as the input channel gain controls -∞ to +15dB. The "u" symbol at the knob's 12:00 position indicates unity gain when the 450's output is driving a balanced input. The 450 uses a differential output driver that drops the output level by 6db when connected to an unbalanced input. This does not adversely affect the audio quality whatsoever and is easily fixed by increasing the output gain knob setting by 6dB.

Rear Panel

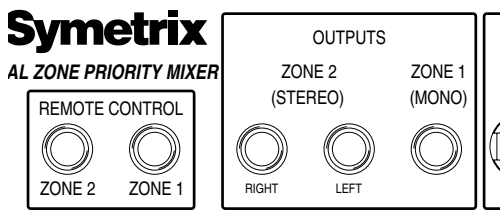

Remote Control - There are two ways to externally control the volume of the 450's Zone Outputs. Both options render the front panel master gain control inactive.

Option #1 - The easiest method is the old volume-knob-in-a-wall-plate. Use a 50k linear potentiometer and wire it as follows on the next page in diagrams 1 or 2.

The remote control cable is not carrying any audio signal, just DC control voltage. This means that you can use a very long cable (up to 1000') without degrading the 450's performance whatsoever. To achieve this, you must use 20-22 gauge, three conductor plus ground cable and wire it according to diagram 2.

Option #2 - If you're using a programmable remote control system that has the ability to supply an external voltage to the 450, no problemo. Wire it as seen in Diagrams 3 or 4 on the following page.

The dB/Voltage gain scale is 5dB/V, Unity gain = 11.5V. Note that the +15V control voltage supplied by the 450 (on the tip of the TRS connector) is not used in this configuration. This is okay, it won't hurt anything. In fact, you can save a little money on your remote cable by using one conductor plus ground for short cable runs (see diagram 3) or two conductor plus ground for long runs (see diagram 4).

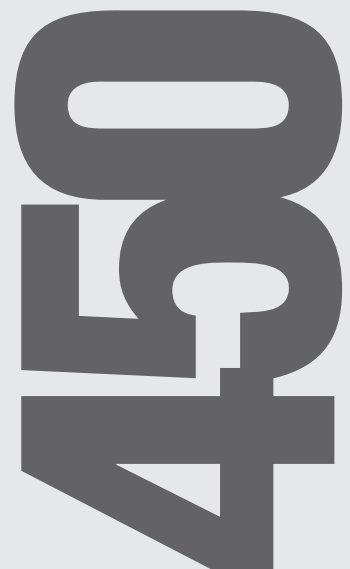

Remote Control Wiring

Diagram 1

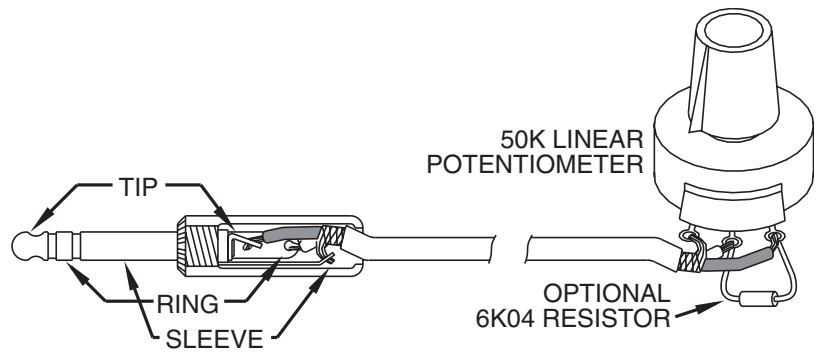

Diagram 2

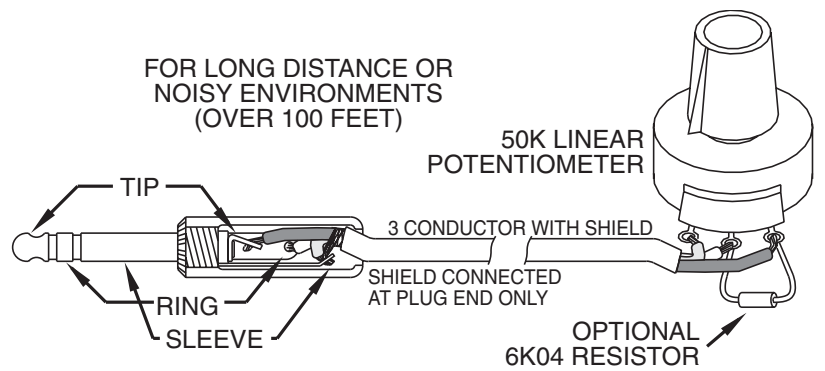

Diagram 3

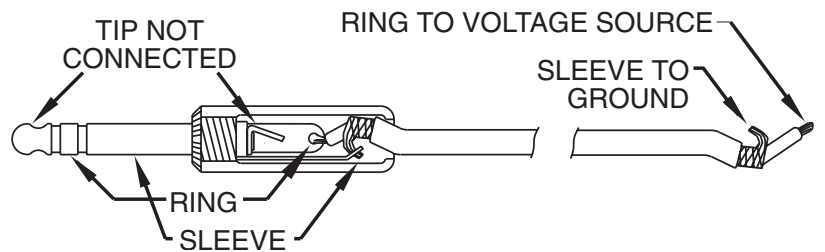
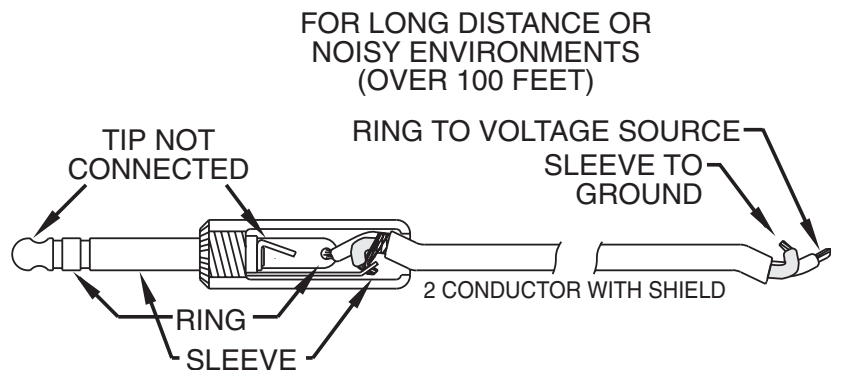

Diagram 4



450

Priority Levels - The term “priority override” refers to the 450’s ability to selectively mute it’s “low priority” inputs when audio signal is present on it’s “high priority” inputs. There are actually four different levels of priority, assigned as follows:

Input	Priority Level
Mic/Line In 1	Priority One (highest)
Mic/Line In 2	Priority Two (not so high)
Line In 3-4	Priority Three (even lower)
Line In 5-6, 7-8, 9-10	No priority

When audio is detected on a Priority input, all inputs with a lower Priority Level will mute until audio is no longer detected on the higher Priority Level input (see the diagram below). It’s important to note that the Priority Override Muting function is directly linked to an input’s zone assignment.

Priority Override Adjustment - This control is the trim adjustment found next to each Zone Out Master level control on the 450’s front panel (see the front panel drawing on page 7). It varies the trigger threshold of the Priority Override muting function. i.e. The muting function activates when the audio level on a Priority channel exceeds this setting. To disable the Override function for either Zone Out, set the trim control to the Bypass position.

Note We recommend that you set the trigger threshold as low as possible if you are using one music source to mute another. An example of this is a restaurant/bar system that uses a CD jukebox to automatically mute the TV/video feed. A low threshold will prevent the “low priority input” from un-muting during quiet musical passages.

Note In a paging system with a live (i.e. no on/off switches) paging mic, you may want to set the trigger threshold higher to prevent background noise from activating the muting function.

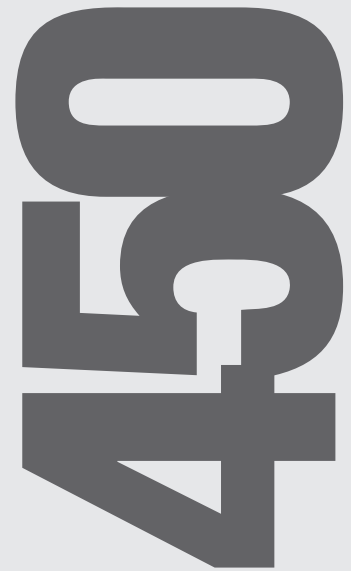
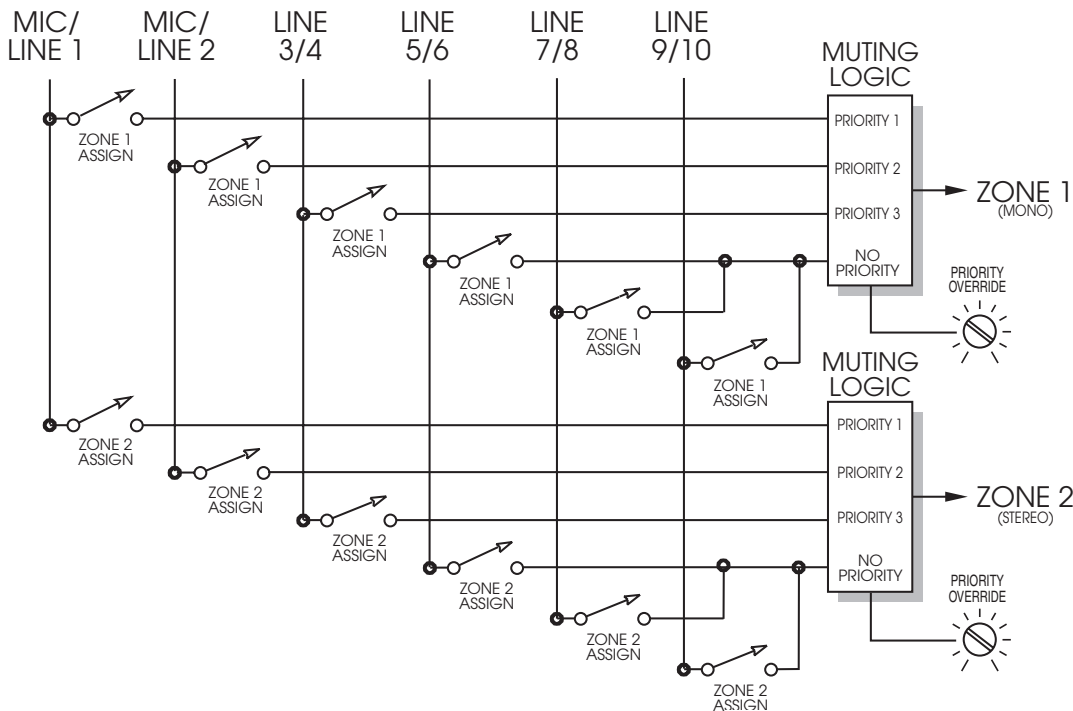

Two Zone Foreground Music with Paging

The following is a layout of a typical restaurant/bar combination system. When someone makes an announcement, the announce audio goes only to Zone 2 which we have drawn as a stereo sound system in the bar area. The 450 mutes only the foreground music's feed to that zone, leaving the Zone 1 (the dining room) music feed live. It's like having two separate mixers in one chassis.

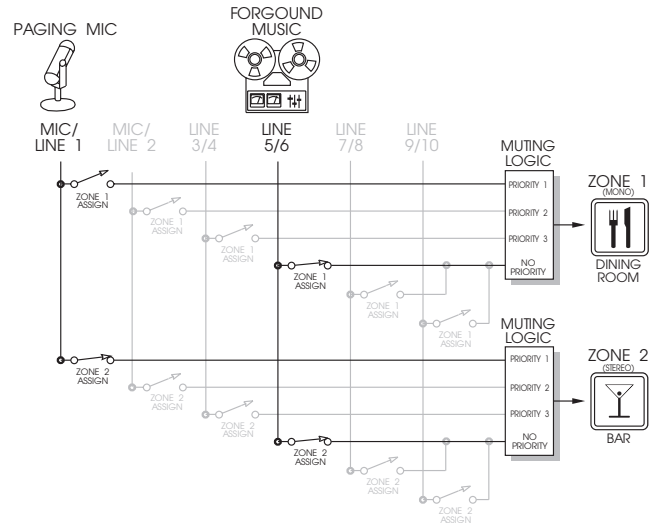

Mic and PBX Paging with Emergency Override

The reason that we included two mic/line inputs as the two top priority levels is to accommodate the needs of industrial paging systems. The following diagram shows how the Priority Override Muting system handles multiple paging sources. The paging mic overrides PBX pages. Both of these, however, are muted by the fire alarm/evacuation announce system.

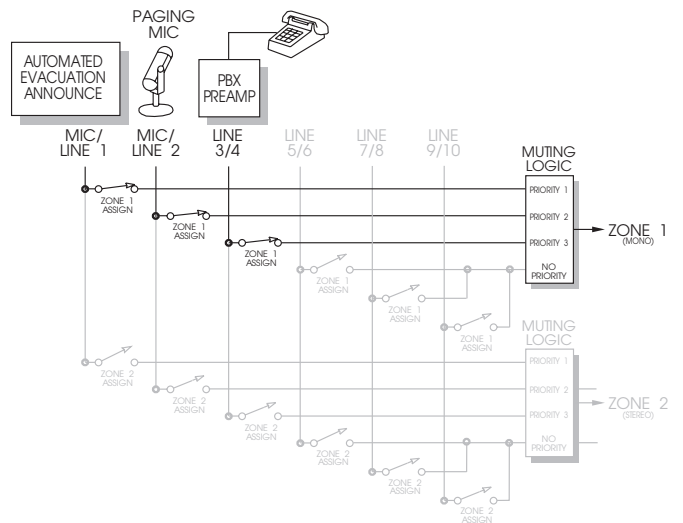

450

Meeting/Presentation Rooms with Remote Control

In meeting rooms, the 450 is flexible enough to handle both speech reinforcement and audio playback at the same time, even if you're using two separate speaker systems. In the diagram below, note that the remote control jacks allow the user to adjust the music and mic volume separately from within the meeting room.

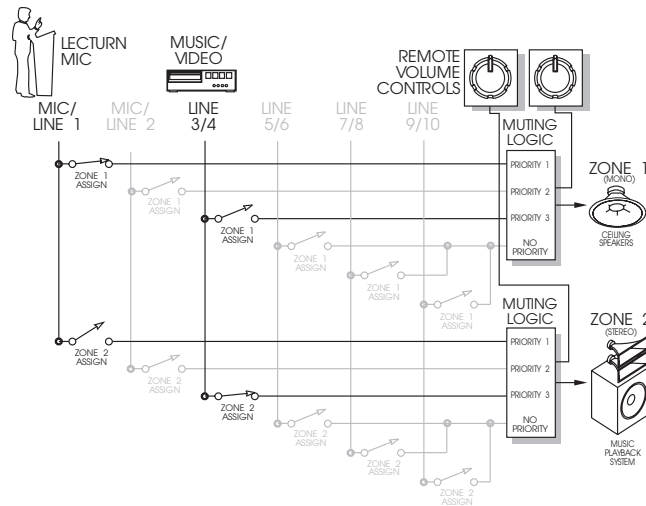

Subgrouping with Remote Control

In the following diagram, we present an idea that you will find useful in hotels and convention centers. The music sources (inputs 5-10) are assigned only to the zone 1 output. A patch cord connects this output to Line Input 3, which is assigned **only** (this is important) to Zone 2. The Zone 2 output is then fed to the amplifier's that drive the speakers. A remote control, conveniently located near the paging mic, is connected to the Zone 1 output. This configuration gives the staff convenient control over the music volume but leaves the paging volume untouched. This can be especially useful in systems where the staff wants control over the background music volume, but the automated emergency announce system must always be heard.

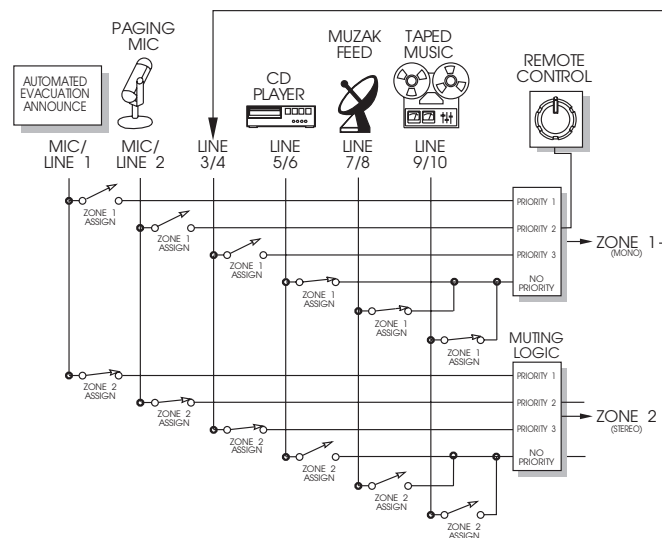

450

There is no output signal:

Check the AC power connections to the 450.

Check input and output cables and connections.

Determine that there really is a signal coming from the source and that it is getting to the 450.

Make sure that the input signal is assigned to Zone 1 or Zone 2 or both.

Distortion in the output signal:

Check the input signal. Is it overdriving the 450's input? If so, reduce the incoming signal level or, in the case of microphone signals, use the 450's microphone pad.

Is the incoming signal already distorted? Listen "up stream" from the 450 to determine that you are feeding it a clean signal(s).

Buzz in the output:

Check input and output connector wiring.

Check for ground loops between interconnected system equipment.

Are all system components on the *same* AC ground?

Noise (hiss):

Check input signal levels and input level control settings. The input may be too low in level. If so, boost the incoming signal if possible. If the incoming signal is Mic level, make sure that the Mic/Line Switch for that input is set to "Mic".

Is the input signal already noisy? Listen "up stream" from the 450 to determine that you are feeding it a clean signal(s).

The 450 doesn't power up or doesn't respond properly:

Consult a qualified service technician or the Symetrix factory.

450

Architects and Engineers Specifications

The audio microphone and line mixer shall be a high performance unit occupying a single rack space (1U).

The unit shall have two low impedance, balanced microphone/line inputs with connection via female XLR. Each microphone/line input shall have a rear panel pushbutton which shall bypass the mic preamp circuitry. Each input shall also have a switch to reduce the gain of the mic input by 20dB. Associated with each microphone input shall also be a front panel level control potentiometer whose purpose is to establish the level of the microphone channel as it is mixed to either a mono output zone, a stereo output zone, or both simultaneously. Each microphone input shall also have a first order low cut filter with a 115Hz rolloff frequency.

The mic/line mixer shall have four stereo, line level inputs. Each input shall be assignable to either a monaural output zone, a stereo output zone, or both. Associated with each line input shall be a level control potentiometer whose purpose is to establish the level of the line level output signal as it is mixed to either a mono output zone, a stereo output zone, or both simultaneously.

The 450 shall incorporate a four level priority muting system as follows. High priority inputs shall mute or duck all lower priority inputs that are assigned to the same output zone when audio is present at the higher priority input. There shall be a threshold control in each zone master section which determines the minimum level of audio that will trigger the muting/ducking function. Priority shall be assigned as follows: Mic/Line In 1 – Priority 1, Mic/Line In 2 – Priority 2, Line In 3-4 – Priority 3, Line In 5-6, 7-8, 9-10 – No Priority.

Independent master output level controls shall be provided for both the monaural output zone and the stereo output zone. LED peak meters shall indicate the actual output level regardless of the nature of the load.

Independent means shall be provided to remotely control the output level of the mono output zone and the stereo output zone. Rear panel jacks shall be provided to accept connections from standard 50K linear potentiometers for this purpose. When wired for remote control, the front panel output zone level controls shall be disabled.

The mic/line mixer shall be a Symetrix, Inc. model 450 Dual Zone Priority Mixer.

Specifications

Audio

Microphone Inputs	Two, Low Impedance, Balanced
Mic Common Mode Rejection @ 1 kHz, 1V RMS	>85 dB
Phantom Power	+48V (10ma per input max)
Line Inputs	Four, Stereo
Line Input Impedance	>10k Ohms, Balanced
Line Input Common Mode Rejection @ 1 kHz, 1V RMS	>40 dB
Maximum Line Input Level	+24 dBu Balanced, +18 dBu Unbalanced
Frequency Response, Any Input to Any Output	±1 dB, 20 Hz to 20 kHz

Connections

Microphone Inputs	XLR Female (pin 2 high)
Line Inputs	¼" TRS (tip is high), RCA-phono (Unbalanced)
Line Outputs	¼" TRS (tip is high)
Remote Volume Control Inputs	¼" TRS

Physical

Size (hwd)	1.72 x 19 x 6.5 inches, 4.37 x 48.26 x 16.51 centimeters
Weight	8 lbs (3.64kg) net

Electrical

Power requirements	117V nominal, 95 to 130V AC, 50 to 60 Hz, 15 watts
	230V nominal, 165 to 255V AC, 50 Hz, 15 watts

Note: The maximum operating ambient temperature is 25 degrees C.

Specifications subject to change without notice.

450

450 Limited Warranty

Symetrix, Inc. expressly warrants that the product will be free from defects in material and workmanship for one (1) year. Symetrix's obligations under this warranty will be limited to repairing or replacing, at Symetrix's option, the part or parts of the product which prove defective in material or workmanship within one (1) year from date of purchase, provided that the Buyer gives Symetrix prompt notice of any defect or failure and satisfactory proof thereof. Products may be returned by Buyer only after a Return Authorization number (RA) has been obtained from Symetrix. Buyer will prepay all freight charges to return the product to the Symetrix factory. Symetrix reserves the right to inspect any products which may be the subject of any warranty claim before repair or replacement is carried out. Symetrix may, at its option, require proof of the original date of purchase (dated copy of original retail dealer's invoice). Final determination of warranty coverage lies solely with Symetrix. Products repaired under warranty will be returned freight prepaid by Symetrix via United Parcel Service (surface), to any location within the Continental United States. At Buyer's request the shipment may be returned via airfreight at Buyer's expense. Outside the Continental United States, products will be returned freight collect.

The foregoing warranties are in lieu of all other warranties, whether oral, written, express, implied or statutory. Symetrix, Inc. expressly disclaims any IMPLIED warranties, including fitness for a particular purpose or merchantability. Symetrix's warranty obligation and buyer's remedies hereunder are SOLELY and exclusively as stated herein.

This Symetrix product is designed and manufactured for use in professional and studio audio systems and is not intended for other usage. With respect to products purchased by consumers for personal, family, or household use, Symetrix **expressly disclaims all implied warranties, including but not limited to warranties of merchantability and fitness for a particular purpose.**

This limited warranty, with all terms, conditions and disclaimers set forth herein, shall extend to the original purchaser and anyone who purchases the product within the specified warranty period.

Warranty Registration must be completed and mailed to Symetrix within thirty (30) days of the date of purchase.

Symetrix does not authorize any third party, including any dealer or sales representative, to assume any liability or make any additional warranties or representation regarding this product information on behalf of Symetrix.

This limited warranty gives the buyer certain rights. You may have additional rights provided by applicable law.

Limitation of Liability

The total liability of Symetrix on any claim, whether in contract, tort (including negligence) or otherwise arising out of, connected with, or resulting from the manufacture, sale, delivery, resale, repair, replacement or use of any product will not exceed the price allocable to the product or any part thereof which gives rise to the claim. In no event will Symetrix be liable for any incidental or consequential damages including but not limited to damage for loss of revenue, cost of capital, claims of customers for service interruptions or failure to supply, and costs and expenses incurred in connection with labor, overhead, transportation, installation or removal of products or substitute facilities or supply houses.

450

Servicing the 450

If you have determined that your 450 requires repair services and you live *outside* of the United States please contact your local Symetrix dealer or distributor for instructions on how to obtain service. If you reside in the U.S. then proceed as follows:

At the Symetrix factory, Symetrix will perform in-warranty or out-of-warranty service on any product it has manufactured for a period of five years from date of manufacture.

Before sending anything to Symetrix, contact our Customer Service Department for a return authorization (RA) number. The telephone number is (425) 787-3222, Monday through Friday, 8AM (800 hours) though 4:30 PM (1630 hours), Pacific Time.

In-warranty Repairs

To get your 450 repaired under the terms of the warranty:

1. Call us for an RA number.
2. Pack the unit in its original packaging materials.
3. Include your name, address, daytime telephone number, and a brief statement of the problem.
4. Write the RA number on the outside of the box.
5. Ship the unit to Symetrix, freight prepaid.

We do *not* accept freight collect shipments.

Just do these five things, and repairs made in-warranty will cost you only one-way freight charges. We'll prepay the return (surface) freight.

If you choose to send us your product in some sort of flimsy packaging, we'll have to charge you for proper shipping materials. If you don't have the factory packaging materials, then do yourself a favor by using an oversize carton, wrap the unit in a plastic bag, and surround it with bubble-wrap. Pack the box full of Styrofoam peanuts. Be sure there is enough clearance in the carton to protect the rack ears (you wouldn't believe how many units are returned with bent ears). We won't return the unit in anything but Symetrix packaging for which we will have to charge you. Of course, if the problem turns out to be operator inflicted, you'll have to pay for both parts and labor. In any event, if there are charges for the repair costs, you will pay for the return freight. All charges will be COD unless you have made other arrangements (prepaid, Visa or Mastercard).

Out-of-warranty Repairs

If the warranty period has passed, you'll be billed for all necessary parts, labor, packaging materials, and freight charges. Please remember, you must call for an RA number before sending the unit to Symetrix.

450

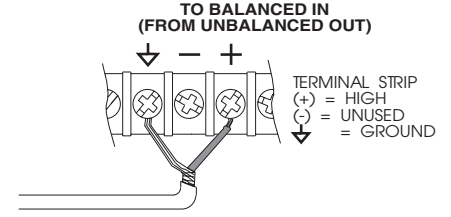
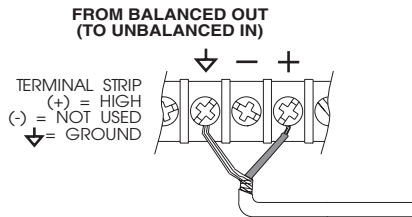
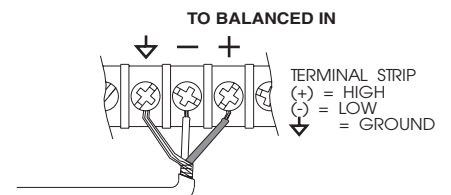
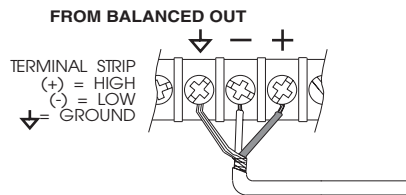
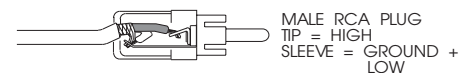
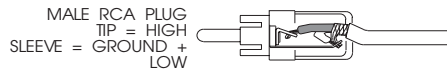
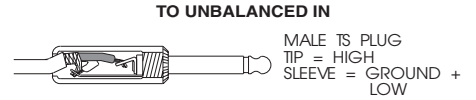
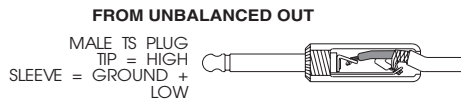
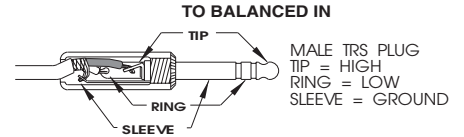
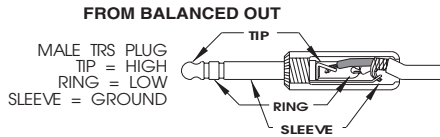
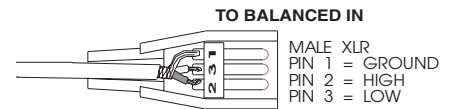
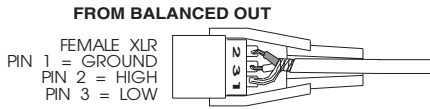

**FROM ELECTRONIC, NON-TRANSFORMER
BALANCED OUTPUT (TYPICAL OF SYMETRIX PRODUCTS)
TO UNBALANCED INPUTS**

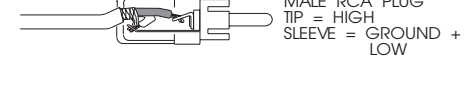
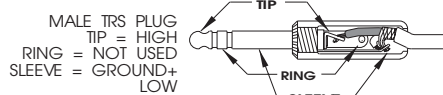
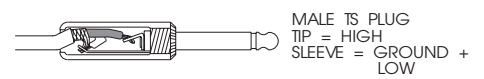
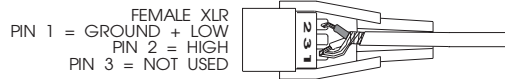

450

Declaration of Conformity

We, **Symetrix Incorporated**, 14926 35th Ave. West, Lynnwood, Washington, USA,
declare under our sole responsibility that the product:

450 Dual Zone Priority Mixer

to which this declaration relates, is in conformity with the following standards:

EN 60065
Safety requirements for mains operated electronic and related
apparatus for household and similar general use.

EN 50081-1
Electromagnetic compatibility - Generic emission standard
Part 1: Residential, commercial, and light industry.

EN 50082-1
Electromagnetic compatibility - Generic immunity standard
Part 1: Residential, commercial, and light industry.

The technical construction file is maintained at:

Symetrix, Inc.
14926 35th Ave. West
Lynnwood, WA, 98037-2303
USA

The authorized representative located within the European Community is:

World Marketing Associates
P.O. Box 100
St. Austell, Cornwall, PL26 6YU, U.K.

Date of issue: 1 November 1995

Place of issue: Lynnwood, Washington, USA

Authorized signature: _____

Dane Butcher, President, **Symetrix Incorporated**.

450

450

 **Symetrix**



Symetrix, Inc.

14926 35th Ave. West
Lynnwood, WA, 98037-2303
USA

Tel: (425) 787-3222

Fax: (425) 787-3211

Website: <http://www.symetrixaudio.com>

Email: symetrix@symetrixaudio.com