

**SONY®**

DIGITAL AUDIO MIXING CONSOLE

**OXF-R3**

OPERATION MANUAL English

1st Edition (Revised 4)

Software Version 3.0 and Later

## CAUTION

Installation has to be done by a SONY authorized technician.

## WARNING

To prevent fire or shock hazard, do not expose the unit to rain or moisture.

To avoid electrical shock, do not open the cabinet. Refer servicing to qualified personnel only.

## VORSICHT

Um Feuergefahr und die Gefahr eines elektrischen Schlages zu vermeiden, darf das Gerät weder Regen noch Feuchtigkeit ausgesetzt werden.

Um einen elektrischen Schlag zu vermeiden, darf das Gehäuse nicht geöffnet werden. Überlassen Sie Wartungsarbeiten stets nur einem Fachmann.

## For customers in the U.S.A

### WARNING

This equipment has been tested and found to comply with the limits for a Class A digital device, pursuant to Part 15 of the FCC Rules. These limits are designed to provide reasonable protection against harmful interference when the equipment is operated in a commercial environment. This equipment generates, uses, and can radiate radio frequency energy and, if not installed and used in accordance with the instruction manual, may cause harmful interference to radio communications. Operation of this equipment in a residential area is likely to cause harmful interference in which case the user will be required to correct the interference at his own expense.

You are cautioned that any changes or modifications not expressly approved in this manual could void your authority to operate this equipment.

The shielded interface cable recommended in this manual must be used with this equipment in order to comply with the limits for a digital device pursuant to Subpart B of Part 15 of FCC rules.



This symbol is intended to alert the user to the presence of important operating and maintenance (servicing) instructions in the literature accompanying the appliance.

## For customers in Europe

This product with CE marking complies with both the EMC Directive (89/336/EEC) and the Low Voltage Directive (73/23/EEC) issued by the Commission of the European Community.

Compliance with these directives implies conformity to the following European standards:

- EN60950 : Product Safety
- EN55103-1: Electromagnetic Interference (Emission)
- EN55103-2: Electromagnetic Susceptibility (Immunity)

This product is intended for use in the following Electromagnetic Environment(s)  
E4 (controlled EMC environment, ex. TV studio)

## Pour les clients européens

Ce produit portant la marque CE est conforme à la fois à la Directive sur la compatibilité électromagnétique (EMC) (89/336/CEE) et à la Directive sur les basses tensions (73/23/CEE) émises par la Commission de la Communauté européenne.

La conformité à ces directives implique la conformité aux normes européennes suivantes:

- EN60950 : Sécurité des produits
- EN55103-1 : Interférence électromagnétiques (émission)
- EN55103-2 : Sensibilité électromagnétique (immunité)

Ce produit est prévu pour être utilisé dans les environnements électromagnétiques suivants:

E4 (environnement EMC contrôlé ex. studio de télévision).

## Für Kunden in Europa

Dieses Product besitzt die CE-Kennzeichnung und erfüllt sowohl die EMV-Directive (89/336/EEC) als auch die Directive Niederspannung (73/23/CEE) der EG-Kommission.

Die Erfüllung dieser Directiven bedeutet Konformität für die folgenden Europäischen Normen:

- EN60950 : Produktsicherheit
- EN55103-1 : Electromagnetische Interferenz (Emission)
- EN55103-2 : Electromagnetische Empfindlichkeit (Immunität)

Dies Produkt ist für den Einsatz unter folgenden elektromagnetischen Bedingungen ausgelegt:  
E4 (kontrollierter EMV-Bereich, z.B. Fernsehstudio)

## Peak Inrush Current

### OXF-CP3048PS

- (1) Power ON, current probe method:  
**50A (100V)**  
**110A (240V)**
- (2) Hot switching inrush current, measured in accordance with European standard EN55103-1:  
**40A (230V)**

### OXF-SP3000

- (1) Power ON, current probe method:  
**40A (100V)**  
**80A (240V)**
- (2) Hot switching inrush current, measured in accordance with European standard EN55103-1:  
**80A (230V)**

### OXF-IO3000

- (1) Power ON, current probe method:  
**20A (100V)**  
**70A (240V)**
- (2) Hot switching inrush current, measured in accordance with European standard EN55103-1:  
**30A (230V)**

## Appel de Courant de Crête

### OXF-CP3048PS

- (1) Mise sous tension (ON), méthode de sondage du courant:  
**50A (100V)**  
**110A (240V)**
- (2) Mesuré conformément à la norme européenne EN55103-1:  
**40A (230V)**

### OXF-SP3000

- (1) Mise sous tension (ON), méthode de sondage du courant:  
**40A (100V)**  
**80A (240V)**
- (2) Mesuré conformément à la norme européenne EN55103-1:  
**80A (230V)**

### OXF-IO3000

- (1) Mise sous tension (ON), méthode de sondage du courant:  
**20A (100)**  
**70A (240V)**
- (2) Mesuré conformément à la norme européenne EN55103-1:  
**30A (230V)**

## Spitzenstrom

### OXF-CP3048PS

- (1) Einschaltstrom, Stromsonde:  
**50A (100V)**  
**110A (240V)**
- (2) Gemessen in EN55103-1:  
**40A (230V)**

### OXF-SP3000

- (1) Einschaltstrom, Stromsonde:  
**40A (100V)**  
**80A (240V)**
- (2) Gemessen in EN55103-1:  
**80A (230V)**

### OXF-IO3000

- (1) Einschaltstrom, Stromsonde:  
**20A (100V)**  
**70A (240V)**
- (2) Gemessen in EN55103-1:  
**30A (230V)**

## **OXF-CP3048PS only**

### **WARNING**

This unit has no power switch.

When installing the unit, incorporate a readily accessible disconnect device in the fixed wiring, or connect the power cord to a socket-outlet which must be provided near the unit and easily accessible.

If a fault should occur during operation of the unit, operate the disconnect device to switch the power supply off, or disconnect the power cord.

### **WARNUNG**

Dieses Gerät hat keinen Netzschalter.

Beim Einbau des Geräts ist daher im Festkabel ein leicht zugänglicher Unterbrecher einzufügen, oder das Netzkabel muß mit einer in der Nähe des Geräts befindlichen, leicht zugänglichen Wandsteckdose verbunden werden.

Wenn während des Betriebs eine Funktionsstörung auftritt, ist der Unterbrecher zu betätigen bzw, das Netzkabel abzuziehen, damit die Stromversorgung zum Gerät unterbrochen wird.

### **WARNING: THIS WARNING IS APPLICABLE FOR USA ONLY.**

If used in USA, use the UL LISTED power cord specified below.

**DO NOT USE ANY OTHER POWER CORD.**

Plug Cap	Parallel blade with ground pin (NEMA 5-15P Configuration)
Cord	Type SJT, three 16 or 18 AWG wires
Length	Less than 2.5 m (8 ft 3 in)
Rating	Minimum 10 A, 125 V

Using this unit at a voltage other than 120V may require the use of a different line cord or attachment plug, or both.

To reduce the risk of fire or electric shock, refer servicing to qualified service personnel.



# Table of Contents

	<b>About This Manual.....</b>	<b>5</b>
<b>Chapter 1</b>		
<b>Overview</b>	<b>1-1 Overview .....</b>	<b>1-2</b>
	<b>1-2 Data Flow.....</b>	<b>1-4</b>
	<b>1-3 Signal Flow.....</b>	<b>1-6</b>
<b>Chapter 2</b>		
<b>Powering The OXF-R3</b>	<b>2-1 OXF-R3 Start-Up.....</b>	<b>2-2</b>
	2-1-1 Start-Up Procedure.....	2-2
	<b>2-2 OXF-R3 Shutdown.....</b>	<b>2-4</b>
	2-2-1 Shutdown Procedure .....	2-4
<b>Chapter 3</b>		
<b>Getting Started</b>	<b>3-1 The Control Surface.....</b>	<b>3-2</b>
	<b>3-2 Fader Paging.....</b>	<b>3-8</b>
	<b>3-3 Assignable Channel Processing.....</b>	<b>3-9</b>
	<b>3-4 Input Channel, Equaliser and Filters.....</b>	<b>3-10</b>
	<b>3-5 Free Assign Area and Dynamics.....</b>	<b>3-11</b>
	<b>3-6 Multitrack, Routing for Multitrack, Super Send Groups and Multi-Format.....</b>	<b>3-12</b>
	<b>3-7 Sends.....</b>	<b>3-13</b>
	<b>3-8 Select To Faders.....</b>	<b>3-14</b>
	<b>3-9 Select To Pans.....</b>	<b>3-17</b>
	<b>3-10 Basic Console Operations.....</b>	<b>3-18</b>
	3-10-1 To Route a Mic or Line Input to the Main Output Bus ...	3-19
	3-10-2 To Set Up a Super Send Group from Channel Inputs .....	3-20
	3-10-3 To Send Signals to Tracks on Tape .....	3-21
	3-10-4 To Monitor Signals to and from Tape.....	3-22
	3-10-5 To Set Up a Stereo Headphone Mix for Foldback 1 O/P	3-23
	3-10-6 To Equalise Signal Feeding the Multitrack .....	3-24
	3-10-7 To Equalise Monitor Signal Post Multitrack .....	3-25
	3-10-8 To Insert Dynamics Pre Multitrack Send.....	3-26
	3-10-9 To Insert Dynamics Post Multitrack Return .....	3-27
	3-10-10 To Bounce Tracks .....	3-28
	3-10-11 To Set Up Super Send Groups from Multitrack .....	3-29
	3-10-12 To Set Up a De-Esser Using Dynamics Side-Chain EQ..	3-30
	3-10-13 To Link Compressor Side-Chains in a Group .....	3-31
	3-10-14 To Link Compressor Side-Chains so that One Channel Controls a Second Channel .....	3-32

# Table of Contents

## Chapter 4 Signal Paths

<b>4-1 The Basic (Default) Signal Path.....</b>	<b>4-2</b>
<b>4-2 Mix-Down Signal Path with Processing Inserted.....</b>	<b>4-4</b>
<b>4-3 Mix-Down with Post Channel Fader Insert.....</b>	<b>4-6</b>
<b>4-4 Recording to a Multitrack.....</b>	<b>4-7</b>
<b>4-5 In-Line Channel Multitrack Recording Set-up.....</b>	<b>4-8</b>
<b>4-6 In-Line Channel with Insert Post Channel Fader (Monitor Function).....</b>	<b>4-9</b>
<b>4-7 SEND 1 Pre Fader Headphones Feed.....</b>	<b>4-10</b>
<b>4-8 SEND 1 Post Fader Headphones Feed.....</b>	<b>4-11</b>
<b>4-9 Broadcast Mode.....</b>	<b>4-12</b>
<b>4-10 Channel Metering.....</b>	<b>4-15</b>
4-10-1 Channel Meter Default.....	4-15
4-10-2 Channel Meters to Input.....	4-15
4-10-3 Send Monitor .....	4-16
4-10-4 Return Monitor .....	4-16
4-10-5 MULTI in Channel Path .....	4-17
<b>4-11 Dynamics Side-Chain Linking.....</b>	<b>4-18</b>
4-11-1 Dynamics Side-Chain Link Right .....	4-18
4-11-2 Dynamics Side-Chain Busses 1-4 .....	4-20
<b>4-12 Mixing to the Main Output Bus.....</b>	<b>4-22</b>
4-12-1 Main Output Bus Set-up .....	4-24
4-12-2 Channel Signal to the Main Output .....	4-26
<b>4-13 Multi-Stem Set-up.....</b>	<b>4-29</b>
4-13-1 Multi-Stem Set-up Procedure .....	4-32
4-13-2 Multi-Stem Monitor Path .....	4-36
4-13-3 Multi-Stem Source Channels .....	4-40
4-13-4 Stem Monitor Switching .....	4-48
4-13-5 Stem Monitor Switching GUI Set-up .....	4-50
4-13-6 Fold-Down Matrix GUIs .....	4-52

## Chapter 5 Control Screens

<b>5-1 The Master Control Screens.....</b>	<b>5-2</b>
<b>5-2 Channel Screens.....</b>	<b>5-5</b>
5-2-1 Routing GUI.....	5-8
5-2-2 I/O GUI .....	5-11
5-2-3 Equaliser & Filters GUI .....	5-28
5-2-4 Dynamics GUI .....	5-29
5-2-5 Preferences GUI.....	5-30
5-2-6 Master GUI (Includes Main Bus Outputs) .....	5-39

## Chapter 6 Technical Descriptions

<b>6-1 OXF-R3 System Description.....</b>	<b>6-2</b>
6-1-1 Control Surface Configurations .....	6-3
<b>6-2 Channels Section Panels.....</b>	<b>6-6</b>
6-2-1 Fader Panel.....	6-6
6-2-2 Select to Faders Panel .....	6-9
6-2-3 Pans Panel .....	6-13
6-2-4 Select to Pans Panel .....	6-15
6-2-5 Input and Equaliser Panel .....	6-17
6-2-6 Free Assign Area & Dynamics Panel .....	6-20
6-2-7 Multitrack Panel .....	6-25

## Chapter 6 Technical Descriptions

6-2-8	Routing Panel .....	6-28
6-2-9	LCD Channel Screen Panel .....	6-31
6-2-10	Sends 1-24 Panel .....	6-32
<b>6-3</b>	<b>Central Section Panels.....</b>	<b>6-38</b>
6-3-1	Master Fader Panel .....	6-38
6-3-2	Monitor Panel .....	6-39
6-3-3	Control Keyboard Panel .....	6-62
6-3-4	Super Send Groups, Send Outputs and Multi-Format Panel .....	6-76
6-3-5	Central Section Faders .....	6-86
6-3-6	Control LCD Screen Panel .....	6-87
6-3-7	QWERTY Keyboard .....	6-88
6-3-8	Trackerballs .....	6-89
<b>6-4</b>	<b>Meter Bridge.....</b>	<b>6-90</b>
6-4-1	Mono Channel Meters .....	6-90
6-4-2	Stereo Centre Section Meters .....	6-92
6-4-3	Other Meter Bridge Indicators .....	6-95
<b>6-5</b>	<b>Signal Processing Rack.....</b>	<b>6-96</b>
6-5-1	SP Rack Modules .....	6-96
<b>6-6</b>	<b>I/O Racks.....</b>	<b>6-97</b>

## Chapter 7 Session Management™

<b>7-1</b>	<b>The Basics.....</b>	<b>7-2</b>
<b>7-2</b>	<b>Files Hierarchy and Automatable Controls.....</b>	<b>7-3</b>
7-2-1	Files Hierarchy .....	7-3
7-2-2	Automatable Controls .....	7-6
<b>7-3</b>	<b>File Data Storage.....</b>	<b>7-7</b>
<b>7-4</b>	<b>Programme Material.....</b>	<b>7-8</b>
<b>7-5</b>	<b>Mixing Overview.....</b>	<b>7-9</b>
7-5-1	Getting Started .....	7-9
7-5-2	Name the Artist/Project and Title .....	7-10
7-5-3	To Set Cue Points .....	7-11
7-5-4	To Automate Cuts .....	7-13
7-5-5	To Save a Mix .....	7-19
7-5-6	To Automate Fader Moves .....	7-20
7-5-7	Dropping Out of Write on Subsequent Mix Passes .....	7-21
7-5-8	To Record Absolute Moves for a Number of Faders .....	7-22
7-5-9	To Trim Fader Moves .....	7-22
7-5-10	To Trim Moves for a Number of Faders .....	7-22
7-5-11	To Automate a Pan Move (or any other Knob) .....	7-23
7-5-12	To Assemble a Mix .....	7-24

(Continued)

# Table of Contents

---

## Chapter 7 Session Management™

<b>7-6 The Session Management™ Screen Pages .....</b>	<b>7-27</b>
7-6-1 The Start-up Logo Screen .....	7-27
7-6-2 The System Screen .....	7-28
7-6-3 The Machines Screen .....	7-30
7-6-4 Artists/Projects & Titles Screen .....	7-32
7-6-5 Mixes & Cues Screen .....	7-35
7-6-6 Merge/Assemble Screen .....	7-40
7-6-7 Track Lists Screen .....	7-46
7-6-8 Snapshots, Copy & Link Screen .....	7-49
7-6-9 Copy Channel Fader Balance to M/T Faders and M/T to Channels .....	7-60
7-6-10 Copy Monitor and M/T Send Fader Balance to Cues .....	7-60
7-6-11 Quick Copy EQ A to B and B to A .....	7-60
7-6-12 Machine Remotes Screen .....	7-61
<b>7-7 Dynamic Automation Moves .....</b>	<b>7-64</b>
7-7-1 Motorised Fader Controls .....	7-64
7-7-2 Automating Faders .....	7-65
7-7-3 To Automate Cuts .....	7-70
7-7-4 To Automate Other Switches .....	7-76
7-7-5 To Automate a Pan Move (or any other knob) .....	7-77
7-7-6 Dropping Out of Write on Subsequent Mix Passes for Knobs .....	7-78
7-7-7 To Trim Pan Moves (or any other knob) .....	7-78
7-7-8 Automation Off and Selective Automation Isolate .....	7-79
7-7-9 Film Mode .....	7-80
7-7-10 Global Ready Enable .....	7-81
<b>7-8 Offline Automation.....</b>	<b>7-84</b>
<b>7-9 MIDI.....</b>	<b>7-89</b>
7-9-1 MIDI Control Pages .....	7-89
7-9-2 Setting MIDI parameters.....	7-90
7-9-3 MIDI Bars & Beats .....	7-93
<b>7-10 Backups.....</b>	<b>7-95</b>
<b>7-11 Preferences .....</b>	<b>7-101</b>

## Appendixes

<b>Software Installation/Upgrades .....</b>	<b>A-2</b>
<b>Multi-Format LS Calibration.....</b>	<b>A-3</b>
<b>Specifications.....</b>	<b>A-6</b>
<b>OXF-R3 Diagnostics.....</b>	<b>A-19</b>
<b>Index .....</b>	<b>I-1</b>

# About This Manual

## **Purpose and intended readers**

This is the operation manual for the OXF-R3 digital audio mixing console. It explains how to use the OXF-R3 to record, mix and output digital audio signals.

This manual is aimed at professionals such as operators and engineers working in high-end recording studios, production companies and broadcasting stations. It is assumed that the reader has prior experience of using professional audio equipment. Use this manual as a reference, by referring to the chapters as summarised below. If however you have limited experience of using this kind of equipment, we recommend that you read through the entire manual. The block diagrams contained in this manual are intended to help you understand the signal flow and operation of the OXF-R3.

## **Model numbers covered by this manual**

This manual refers in general terms to the OXF-R3. The illustrations show the 24-C-24 version, which is the current model.

## **Organisation**

This manual is divided into the following seven chapters and four appendixes:

### **Chapter 1 Overview**

Introduces the features of the OXF-R3 and how it may be used to configure a complete system.

### **Chapter 2 Powering the OXF-R3**

Includes the system power-up procedure and the boot-up sequence for the host computer.

### **Chapter 3 Getting Started**

Gives an overview of the OXF-R3 control surface describing the principles of operation. The panels are described in enough detail to allow the experienced operator to start using the OXF-R3.

### **Chapter 4 Signal Paths**

Explains the general principles of building signal paths and gives examples of types of signal paths that may be built from the basic default signal path existing at 'fire-up'.

### **Chapter 5 Control Screens**

Lists all the control screens available in the OXF-R3. The screens related to the channels and mixer functions are described in detail.

### **Chapter 6 Technical Descriptions**

Provides the descriptions of all the modules of the OXF-R3, including the names, locations and functions of the controls. This chapter also includes descriptions of the associated SP Rack and I/O Rack system.

### **Chapter 7 Session Management™ System**

Describes the sophisticated and flexible Session Management™ system available to OXF-R3 users, including automation of functions - a key feature of the Session Management™ system. Both static and dynamic automation is possible using the OXF-R3.

## **Appendixes**

Provide the information for the following:

- Software installation/upgrades
- Multi-format LS calibration
- Specifications
- Diagnostic facilities (There are no user operable diagnostic facilities provided in this version of the OXF-R3).

## Conventions used in this manual

This manual uses the following conventions:

Chapter 3, Section 10

• **3-10 Basic Console Operations**

Subsection 5 within Section 10

• **3-10-5 To Equalise Signal To Multitrack**

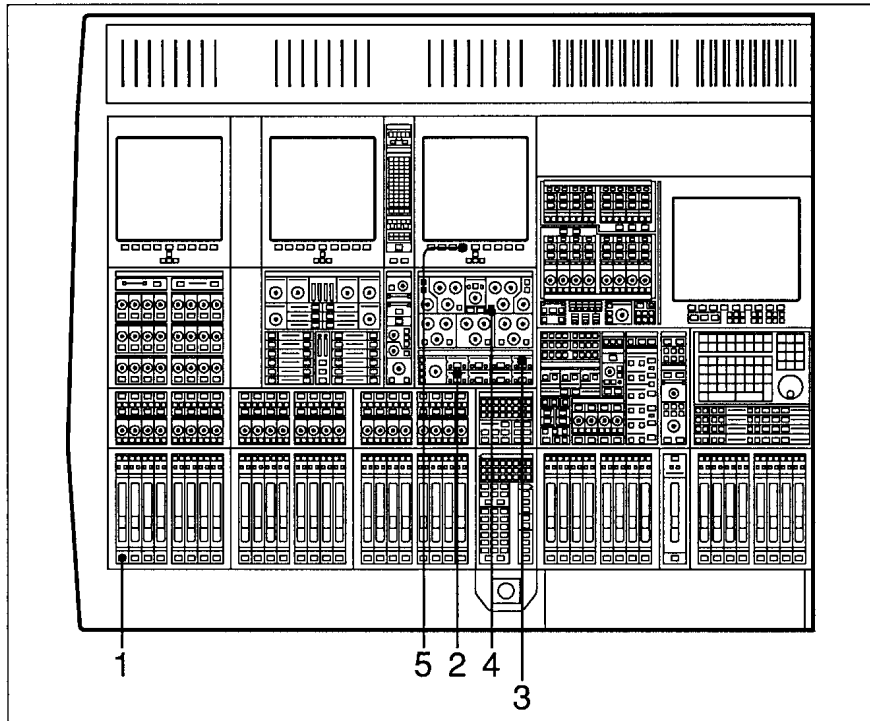

To equalise the signal to multitrack

Operation Step number

- **1** Press the ACCESS button for the desired Channel.
- **2** At the Input Channel & Inserts panel, select 'MULTI' in 'window' no. 5. Select the large IN button to insert the multitrack into the signal path.
- **3** At the same panel, select 'EQ' in 'window' no. 4 and select the large IN button to insert the equaliser into the signal path.
- **4** On the upper section of the same panel, press the individual IN buttons for the bands required. Adjust as necessary.
- **5** Select the EQ soft key for the screen above the equaliser panel to view the parameters and response curve graph.

Cross-reference within the manual

(Refer to Chapter 5 – Control Screens, for details of this screen)

Important note

**Note:**  
The screen defaults to a combination display of 5 Band Equaliser and High and Low Filter curves.

---

## **Related manuals**

In addition to this operation manual, the following manuals are available for the OXF-R3:

- Installation Manual
- Service Manual

# Glossary of Terms

ABS	Absolute	O/B	Outside Broadcast
ADC	Analogue to Digital Converter	O/L	Overload
AES	Audio Engineering Society	PAN	Panoramic
AFL	After Fader Listen	PCB	Printed Circuit Board
ATR	Audio Tape Recorder	PCM	Pulse Code Modulation
AUX	Auxiliary	PFL	Pre Fader Listen
CAL	Calibrated or Calibration	PSU	Power Supply Unit
CH	Channel	RET	Return
CMRR	Common Mode Rejection Ratio	RSL	Remote Studio Link
CR	Control Room	S-C	Side Chain
DAC	Digital to Analogue Converter	SDDS	Sony Dynamic Digital Sound
DAT	Digital Audio Tape	SDIF	Sony Digital Interface Format
DIV	Divergence	SEL	Select
DYN	Dynamics	SIG	Signal
EBU	European Broadcasting Union	SM	Session Management
EDL	Edit Decision List	SMPTE	Society of Motion Picture & Television Engineers
EQ	Equaliser or Equalisation	SMS	Session Management System
EXT	External	SP	Signal Processing
FILT	Filter	SPL	Sound Pressure Level
FS	Sampling Frequency	SRC	Sample Rate Converter
GDC	Global Delay Compensation	SSG	Super Send Group
GPI	General Purpose Interface	STER	Stereo
GUI	Graphical User Interface	SUR	Surround
HF	High Frequency	S/W	Software
HMF	Higher Mid Frequency	T/B	Talkback
H/W	Hardware	TC	Time Code
I/O	Input/Output	TCF	Time Code Frame
LCD	Liquid Crystal Display	TFT	Thin Film Transistor
LED	Light Emitting Diode	T/LIST	Track List
LF	Low Frequency	TRM	Trim
LMF	Lower Mid Frequency	UPS	Uninterruptable Power Supply
L/R	Left/Right	VCA	Voltage Controlled Amplifier
LS	Loudspeaker	VDU	Video Display Unit
MADI	Multi-Channel Audio Digital Interface	VGA	Video Graphics Array
MF	Mid Frequency		
MIC	Microphone		
MIDI	Musical Instrument Digital Interface		
M.O.	Magneto-Optical (disk)		
MON	Monitor		
M/T	Multitrack		
MTR	Meter		



# Chapter 1 – Overview

This chapter introduces the OXF-R3 digital audio mixing console and describes the main features. An example system configuration and a signal flow diagram are included.

## Chapter 1 Contents

<b>1-1 Overview .....</b>	<b>1-2</b>
<b>1-2 Data Flow .....</b>	<b>1-4</b>
<b>1-3 Signal Flow .....</b>	<b>1-6</b>

# 1-1 Overview

The OXF-R3 is a 'high end' digital audio mixing console system. It comprises four main components:

- Control Console with Modular Control Surface
- Host Computer
- Signal Processing (SP) Rack
- Digital and Analogue I/O Racks

The following illustration shows a basic system concept diagram.

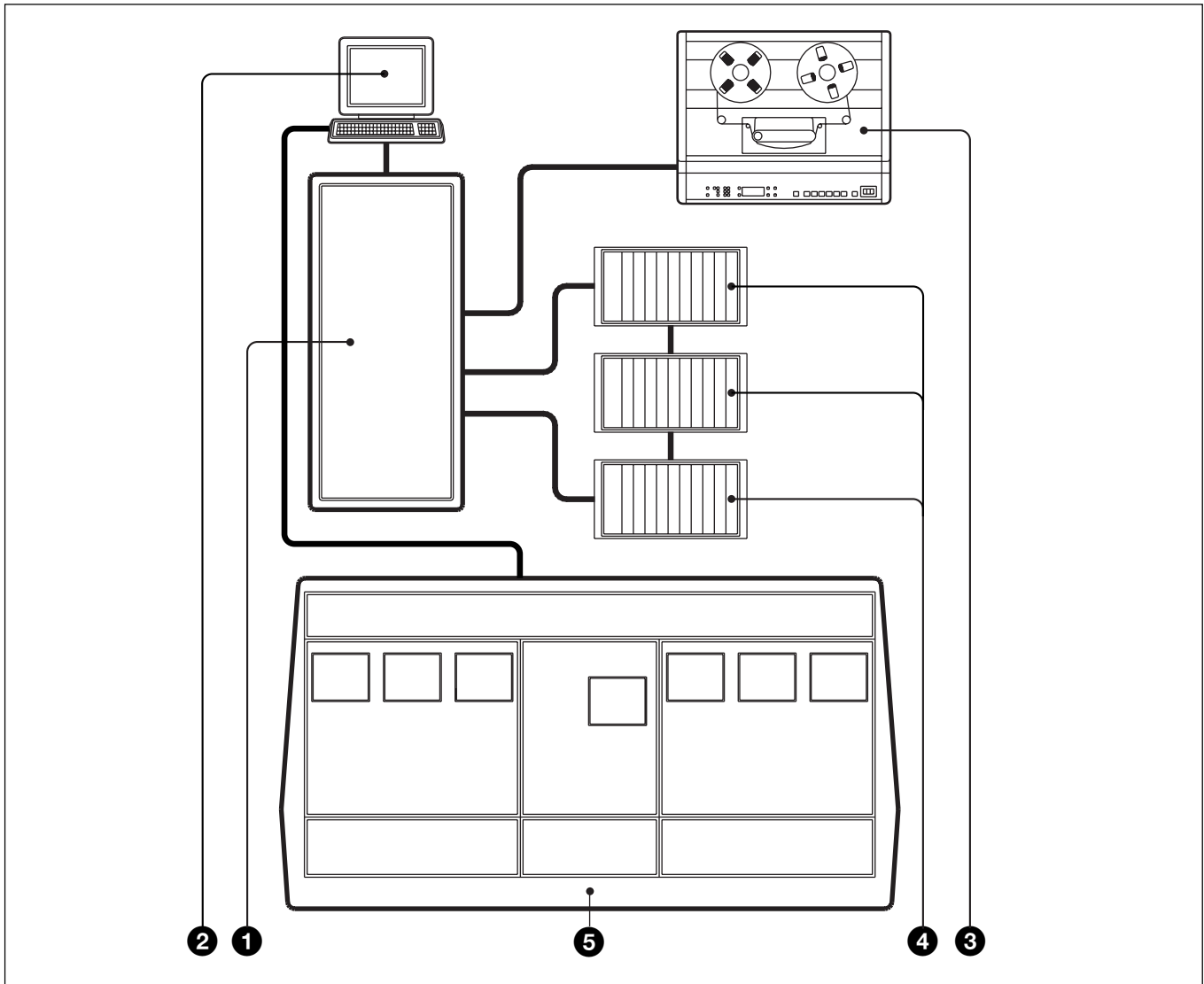

System Concept diagram

- ❶ SP Rack
- ❷ Host Computer
- ❸ Multitrack Tape Recorder(s)
- ❹ Digital and Analogue I/O Racks
- ❺ Control Console

## Control Console

Compared with traditional console designs, the OXF-R3 offers greater flexibility within more compact dimensions by using an assignable control surface.

## Modular Control Surface

The control surface of the OXF-R3 makes extensive use of assignable panels to provide a console of manageable size for either one or two operators, whilst giving greatly increased functionality. The current system is capable of controlling up to 96 full channels and 12 stereo return channels. The modular system divides functionally into the master section, located in the centre, and the channel sections located either side of the master section.

## Signal Processing (SP) Rack

The SP rack is designed to use the minimum number of signal processing cards depending on the system size. A high level Software Design Tools System is used to generate automatically the low level software microcode which runs the SP system. Data links to and from the control console are via Ethernet connections, whilst a MADI interface is used between the SP rack and the I/O racks. Additional bandwidth, available within the MADI signal, is used to pass data for purposes such as remote control of analogue amplifier gain.

## Digital and Analogue I/O Racks

The I/O racks are designed to be located close to the equipment with which they interface. Each I/O rack can contain a mix of up to 56 high quality analogue inputs and/or outputs on 10 analogue I/O cards. Each analogue card handles 4 or 8 inputs and 4 or 8 outputs according to its type. A mix of input and output cards in the same I/O rack may, for example, allow cue outputs for headphones to be local to appropriate microphone sources.

The digital and analogue I/O are housed in a single rack type. Digital I/O has the same capability as the analogue, of up to 56 inputs and 56 outputs per rack via AES/EBU and SDIF-2 (24) modules. The digital I/O system also includes modules for Timecode, 9-Pin, GPI and MIDI. MADI connections may be made directly to the SP rack.

## Machine Control

Machine control for the OXF-R3 is accomplished via Sony 9-Pin control and third party devices such as the “motionworker”, supplied by Motionworks Ltd.

### Note:

*Refer to the Appendixes in this manual for further details of OXF-R3 capabilities.*

# 1-2 Data Flow

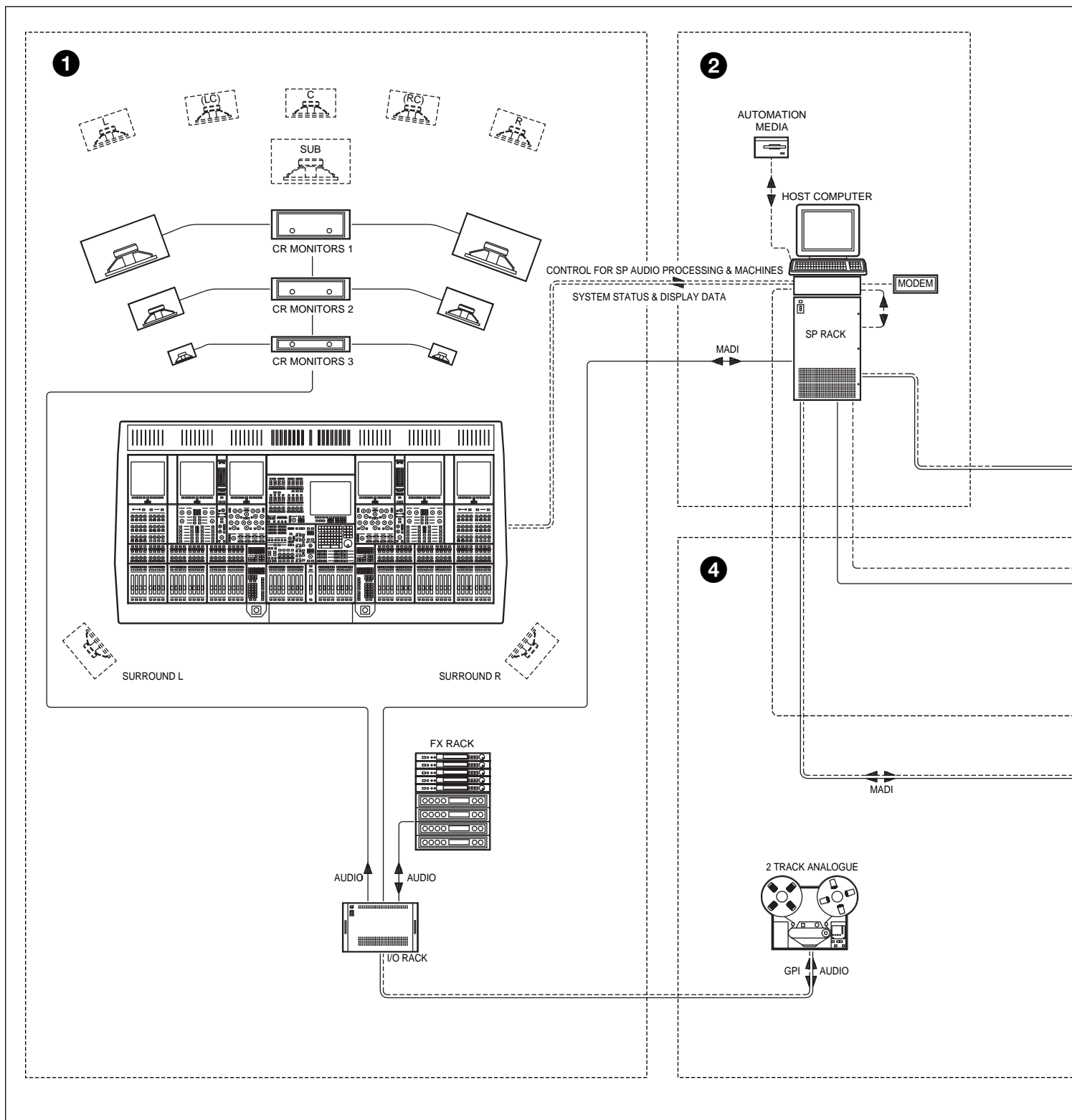

Sample installation illustrating Audio & Control Data flow

- 1 Control Room
- 2 Rack Room

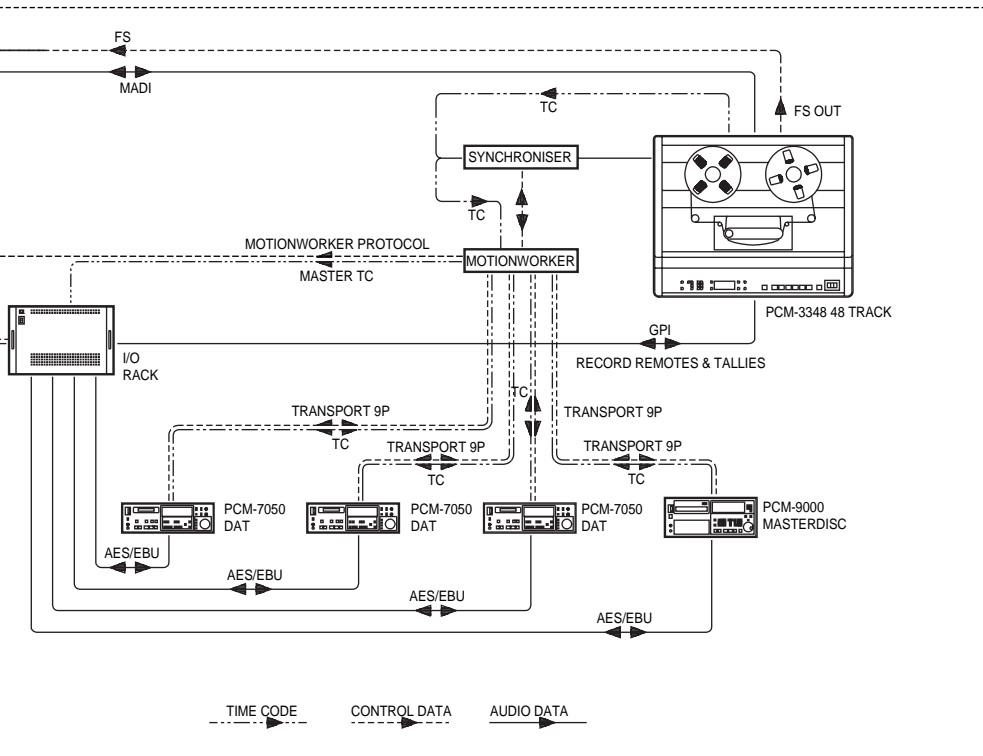
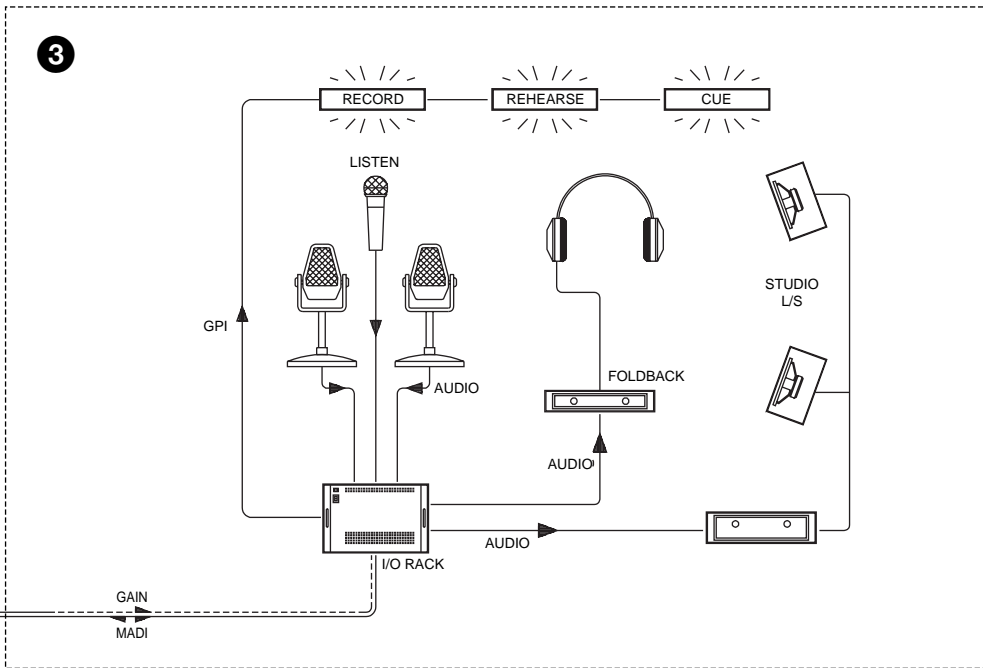

3 Studio

4 Machine Room

# 1-3 Signal Flow

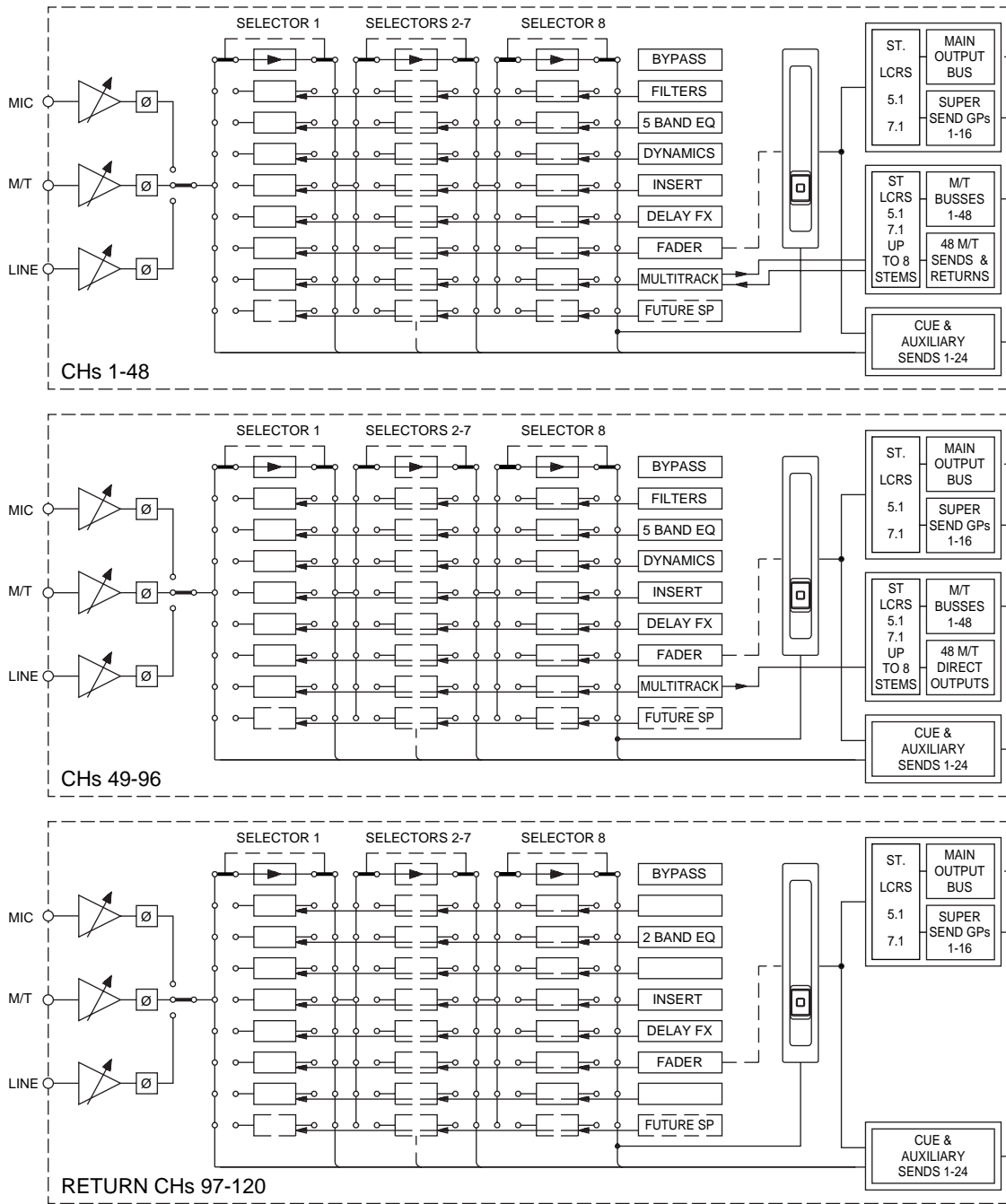

OXF-R3 signal flow

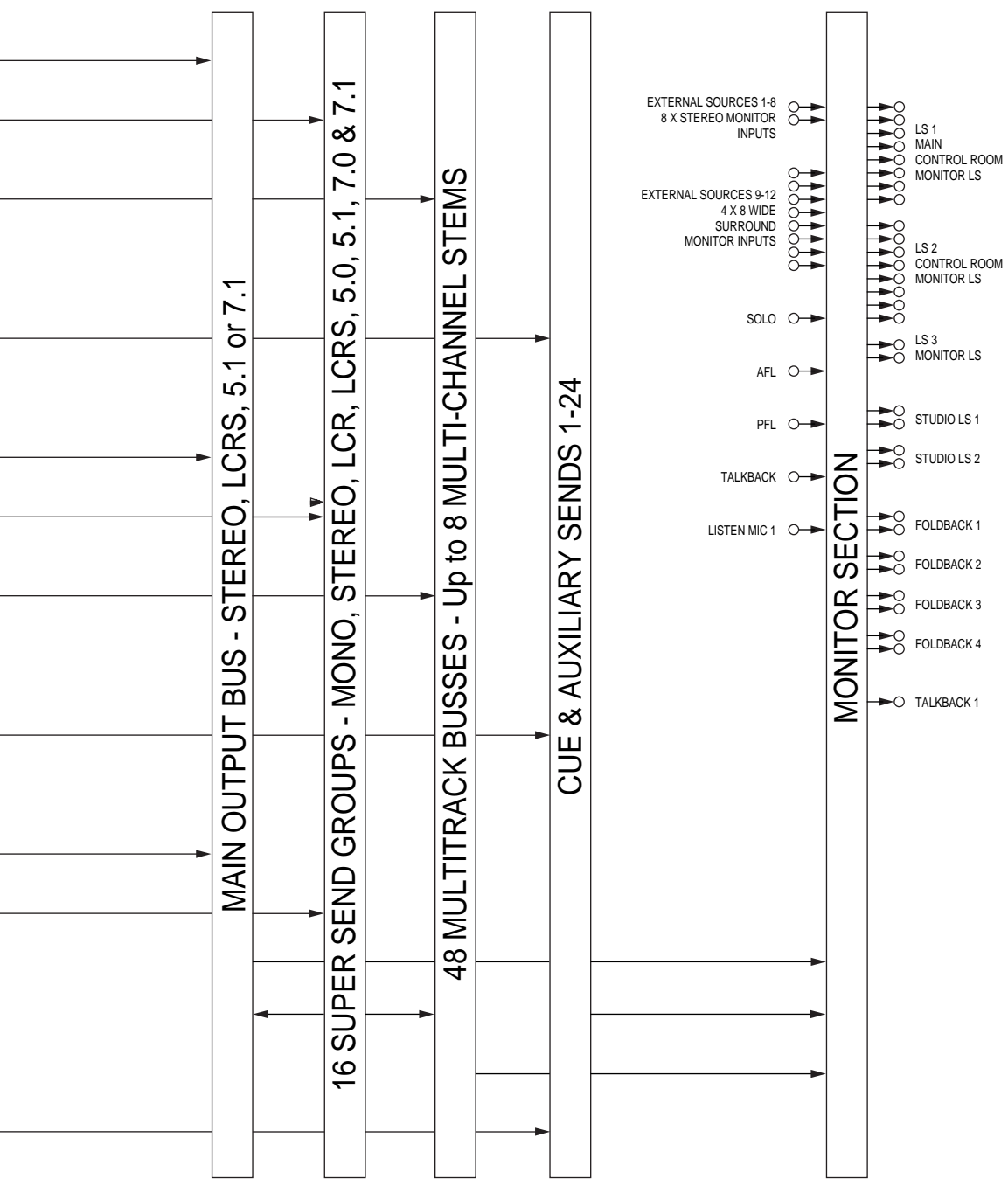





# Chapter 2 – Powering The OXF-R3

This chapter provides step-by-step procedures for starting up the OXF-R3, including the power-up sequence and the booting of the Host Computer. It also includes the procedure for controlled shutdown of the OXF-R3.



## Chapter 2 Contents

<b>2-1 OXF-R3 Start-Up .....</b>	<b>2-2</b>
2-1-1 Start-up Procedure .....	2-2
<b>2-2 OXF-R3 Shutdown .....</b>	<b>2-4</b>
2-2-1 Shutdown Procedure .....	2-4

# 2-1 OXF-R3 Start-Up

## CAUTIONS:

1. Before starting up the OXF-R3, check that all Monitor Loudspeaker Power Amps are turned off or muted.
2. Switch on equipment in the sequence given here, to ensure trouble-free start-up.

## 2-1-1 Start-Up Procedure

1. Check that the motionworker and Lynx Time Code Module are already switched on and running normally.
2. Switch on the power to the SP Rack.
3. Switch on the power to the Host Computer.
4. Switch on the power to the I/O Racks.

**Note:**

*It is important that the I/O racks are switched on in the sequence of the Sync Clock wiring loop connected to the clock inputs of the I/O Racks.*

5. The Host Computer performs its start-up and self-test routines. At the end of these routines, a triple chevron prompt >>> should be displayed on the monitor.
6. Type **b** then press **RETURN** to start the boot-up process for the OXF-R3 system.

**Note:**

*If your Host Computer has been configured for Auto-boot (an option at set-up), the triple chevron prompt will not be displayed and boot-up will proceed automatically.*

7. At the end of the boot-up procedure, the Login field will be displayed on the monitor.
8. Now switch on the power to the control panel. All 7 LCD screens will show activity as programs are downloaded from the Host Computer to the computers within the console. When downloading is completed, an 'X' is displayed in the centre of each screen.

9. Log in at the Host Computer. Note that the user name and password below are the system defaults.

Type **sm** (case-sensitive) then press **RETURN**.

Type in the password: **oxf-r3** (case-sensitive), then press **RETURN**.

**Notes:**

- 1 **oxf-r3** is the default password. This may be changed but its modification must be carried out with help from Sony personnel.
- 2 Login can be initiated while programs are still being downloaded from the Host Computer. It is not necessary to wait until all the console LCD screens are displaying 'X' in their centres.

10. Once logged-in, a window is displayed on the monitor of the Host Computer. Use the mouse to move the cursor into this window entitled STIF. Note that the window surround changes colour from green to red, to indicate that this is now the active window.
11. Check that the console LCD screens are all displaying 'X' before proceeding, then:  
  
Type: **run\_r3** (case-sensitive) then press **RETURN**.
12. Observe that the centre LCD screen in the console displays a summary of the processes being executed by the Host Computer which are displayed in greater detail on the monitor.
13. When the loading of the Netlist is complete, the centre screen of the console displays the OXF-R3 logo.
14. Switch-on is now complete, but wait until all controls on the control panel are initialised (indicated by their lighting up) before operating the system.

## 2-2 OXF-R3 Shutdown

### CAUTION:

Turn off or mute all monitor amplifiers connected to the OXF-R3.

Unless the OXF-R3 is to remain switched off for a prolonged period, it will be more convenient to leave the Clock Synchronisation source running.

### 2-2-1 Shutdown Procedure

1. At the centre LCD screen on the OXF-R3 control surface, use the appropriate softkey to select SYSTEM.

#### Note:

*If necessary, retrace a number of steps through the screens hierarchy to reach this point. Refer to the Screens Structure diagram in Chapter 5 for detailed information on the screen page hierarchy.*

2. On the SYSTEM screen page, click on SYSTEM SHUTDOWN on the right side of the screen if it is displayed.
3. If SHUTDOWN is not displayed click on the 'User field' for a pop-up and click on ADMIN. Enter the admin password (default is **admin** in lower case) and click on OK. The field which includes SYSTEM SHUTDOWN will then appear in the right side of the screen. Click on it. A dialogue box will appear on the screen to request confirmation of Shutdown and ask if current work should be saved. Press **ENTER** on the Control Keyboard or click on OK.
4. The console now shuts down and power to the control surface can be turned off but the STIF and UNIX windows on the Host Computer monitor remain.
5. On the Host Computer, place the mouse cursor in the STIF window and

Type: **exit** (case-sensitive) then press **RETURN**.

#### Note:

*It is important to switch off the power to the control surface for a minimum of 10 seconds before attempting a re-start.*

6. For a re-boot, turn on the power to the control surface again and follow the Start-Up Procedure, in the previous section, from step 11. For a complete power-down, continue with step 7 in this section.

- 
7. To shut down the Host Computer, place the cursor in the UNIX window, and

Type: **su** (case-sensitive) which stands for 'superuser', then press **RETURN**.

8. At the 'password' prompt:

Type the superuser password, **oxf-r3** (case sensitive) is the default, then press **RETURN**.

9. At the prompt which follows:

Type: **shutdown -h now** (case sensitive), then press **RETURN**.

10. Wait for the >>> prompt to appear before powering down the Host Computer, SP and I/O Racks.



# Chapter 3 – Getting Started

This chapter gives an overview of the control surface layout and functionality. It also provides easy to follow, step-by-step procedures for basic operations of the console. These are designed to help the experienced operator become familiar with the OXF-R3 within a short period of time.

## Chapter 3 Contents

<b>3-1</b>	<b>The Control Surface .....</b>	<b>3-2</b>
<b>3-2</b>	<b>Fader Paging .....</b>	<b>3-8</b>
<b>3-3</b>	<b>Assignable Channel Processing .....</b>	<b>3-9</b>
<b>3-4</b>	<b>Input Channel, Equaliser and Filters .....</b>	<b>3-10</b>
<b>3-5</b>	<b>Free Assign Area and Dynamics .....</b>	<b>3-11</b>
<b>3-6</b>	<b>Multitrack, Routing for Multitrack, Super Send Groups and Multi-Format .....</b>	<b>3-12</b>
<b>3-7</b>	<b>Sends .....</b>	<b>3-13</b>
<b>3-8</b>	<b>Select To Faders .....</b>	<b>3-14</b>
<b>3-9</b>	<b>Select To Pans .....</b>	<b>3-17</b>
<b>3-10</b>	<b>Basic Console Operations .....</b>	<b>3-18</b>
3-10-1	To Route a Mic or Line Input to the Main Output Bus ...	3-19
3-10-2	To Set Up a Super Send Group from Channel Inputs .....	3-20
3-10-3	To Send Signals to Tracks on Tape .....	3-21
3-10-4	To Monitor Signals to and from Tape .....	3-22
3-10-5	To Set Up a Stereo Headphone Mix for Foldback 1 O/P	3-23
3-10-6	To Equalise Signal Feeding the Multitrack .....	3-24
3-10-7	To Equalise Monitor Signal Post Multitrack .....	3-25
3-10-8	To Insert Dynamics Pre Multitrack Send .....	3-26
3-10-9	To Insert Dynamics Post Multitrack Return .....	3-27
3-10-10	To Bounce Tracks .....	3-28
3-10-11	To Set Up Super Send Groups from Multitrack .....	3-29
3-10-12	To Set Up a De-Esser Using Dynamics Side-Chain EQ..	3-30
3-10-13	To Link Compressor Side-Chains in a Group .....	3-31
3-10-14	To Link Compressor Side-Chains so that One Channel Controls a Second Channel .....	3-32

# 3-1 The Control Surface

The OXF-R3 comes in two configurations known as the 24-C-24 and the 24-C-0. The basic elements are illustrated below.

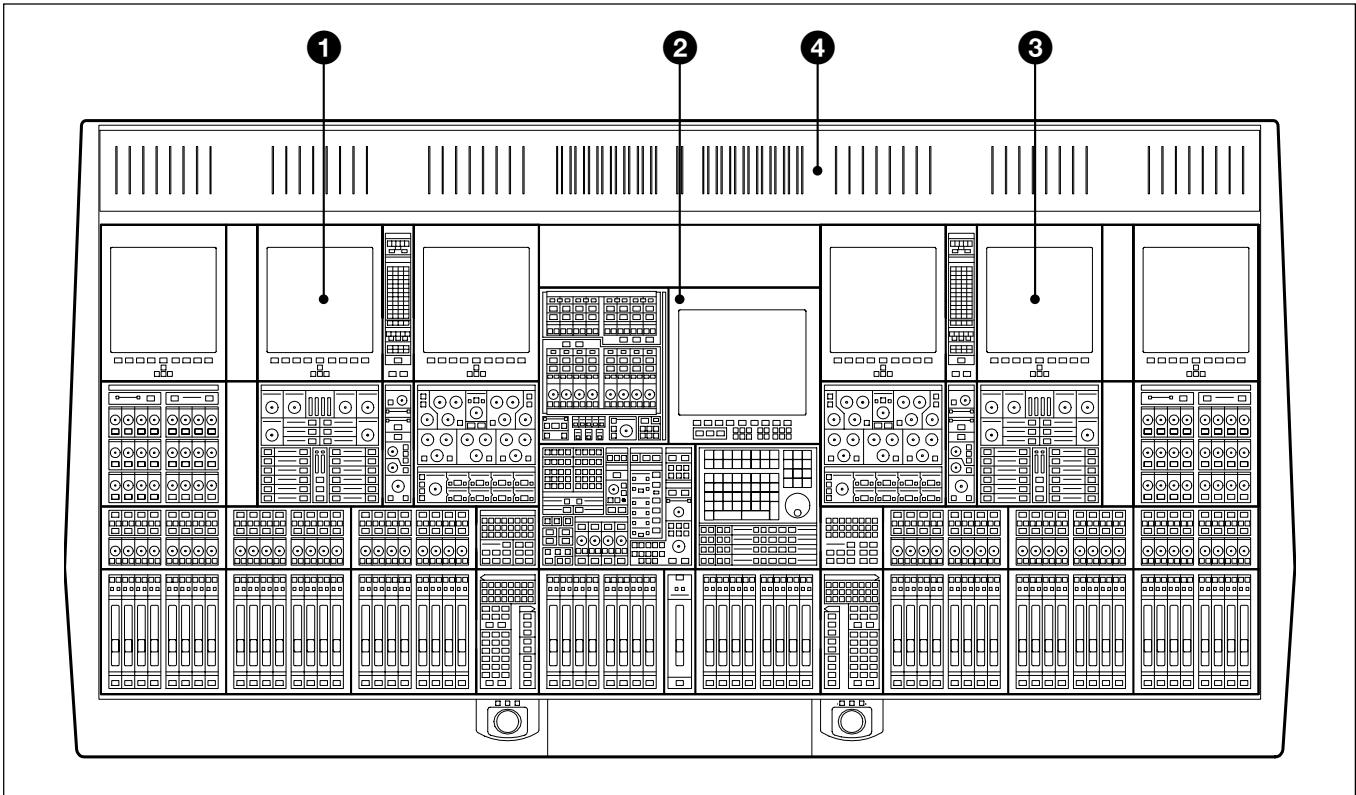

24-C-24 Control Surface Configuration

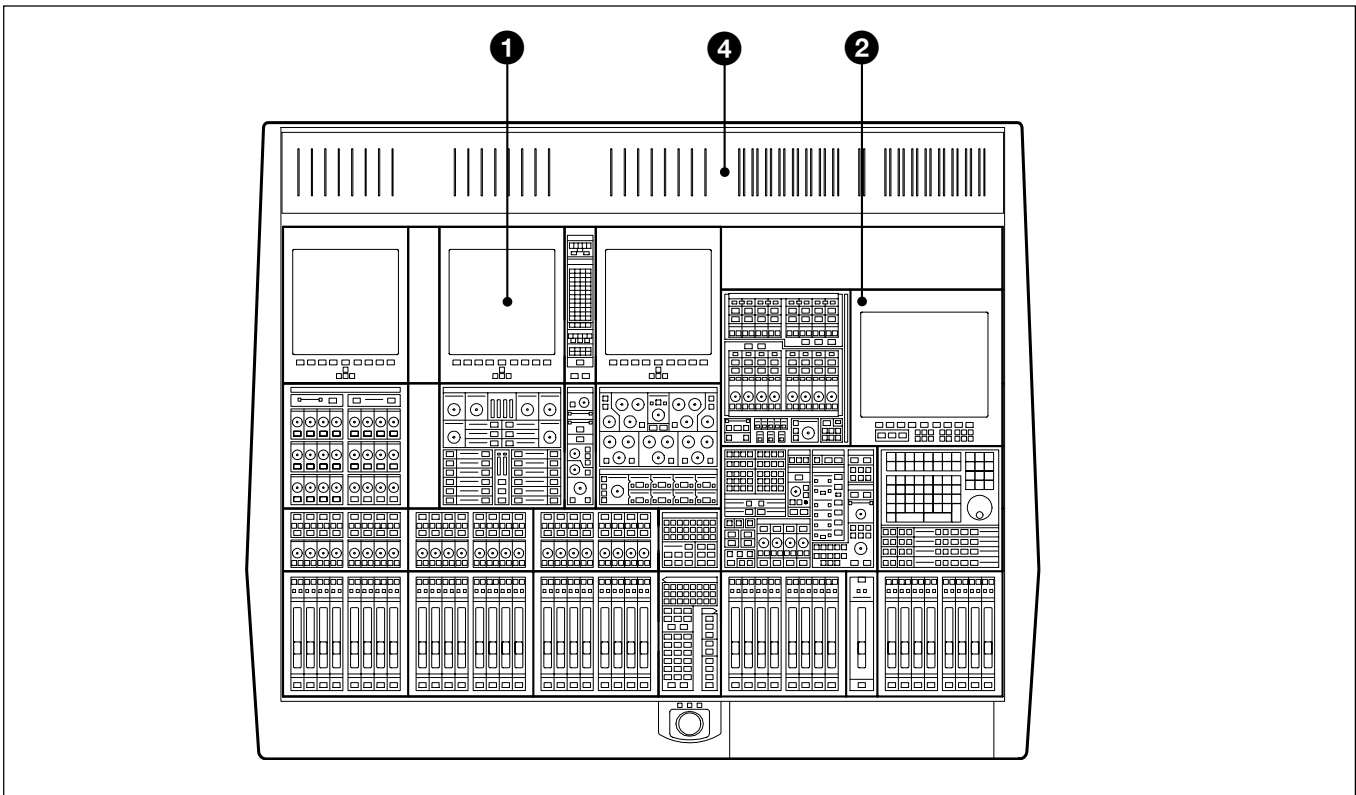

24-C-0 Control Surface Configuration



## Control Surface Elements

- ❶ Left hand 24 Fader Channels Section
- ❷ Central Master Section
- ❸ Right hand 24 Fader Channels Section
- ❹ Meter Bridge

### The Control Surface in general

A key feature of the OXF-R3 is its Assignable Panels, which divide further into four basic areas:

- **INPUT CHANNEL, EQUALISER and FILTERS**
- **FREE ASSIGN AREA & DYNAMICS**
- **MULTITRACK, ROUTING for MULTITRACK, SUPER SEND GROUPS and MULTI-FORMAT**
- **SENDS** (For Foldback and Effects feeds)

The channel section panel areas are mirrored so that every function can be operated from either side of the console, allowing two operators to work on the same channels simultaneously. The ability to have 48 channel faders and their related functions on view at all times is an advantage but everything can be operated from just one 24 fader channel bank and the centre section, as in the more compact 24-C-0 design.

Use the following two diagrams for reference to identify each area as it is explained whilst reading through this manual.

Operation of the control surface can be split into 5 main areas:

1. **USE OF FADER PAGING**
2. **USING ASSIGNABLE SIGNAL PROCESSING**
3. **SELECT TO FADERS FUNCTIONS**
4. **SELECT TO PANS FUNCTIONS**
5. **BUILDING SIGNAL PATHS**  
(Described in detail in Chapter 4)

# 3-1 The Control Surface

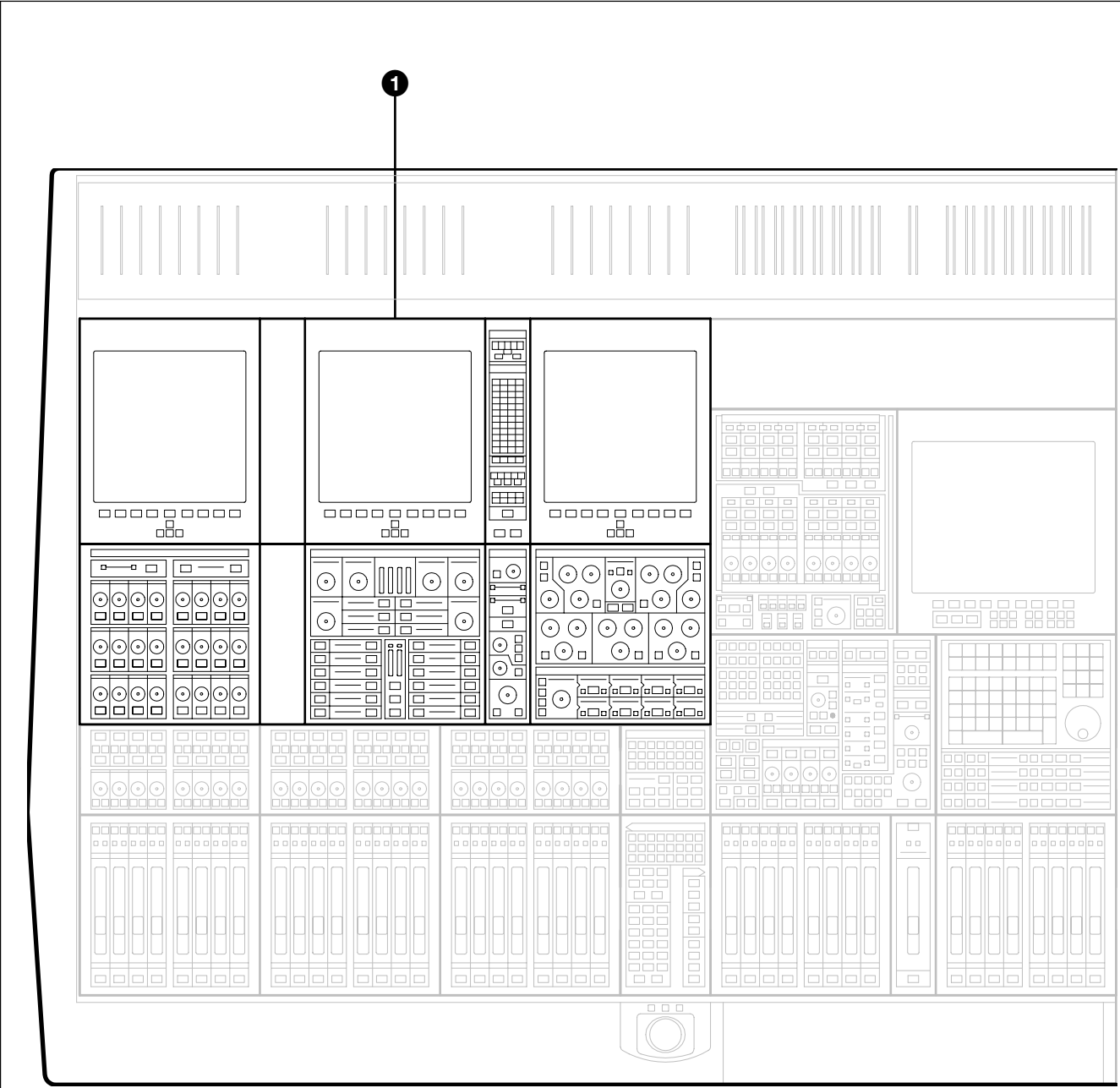

OXF-R3 Assignable Channel Areas

① Left hand assignable channel controls

② Right hand assignable channel controls

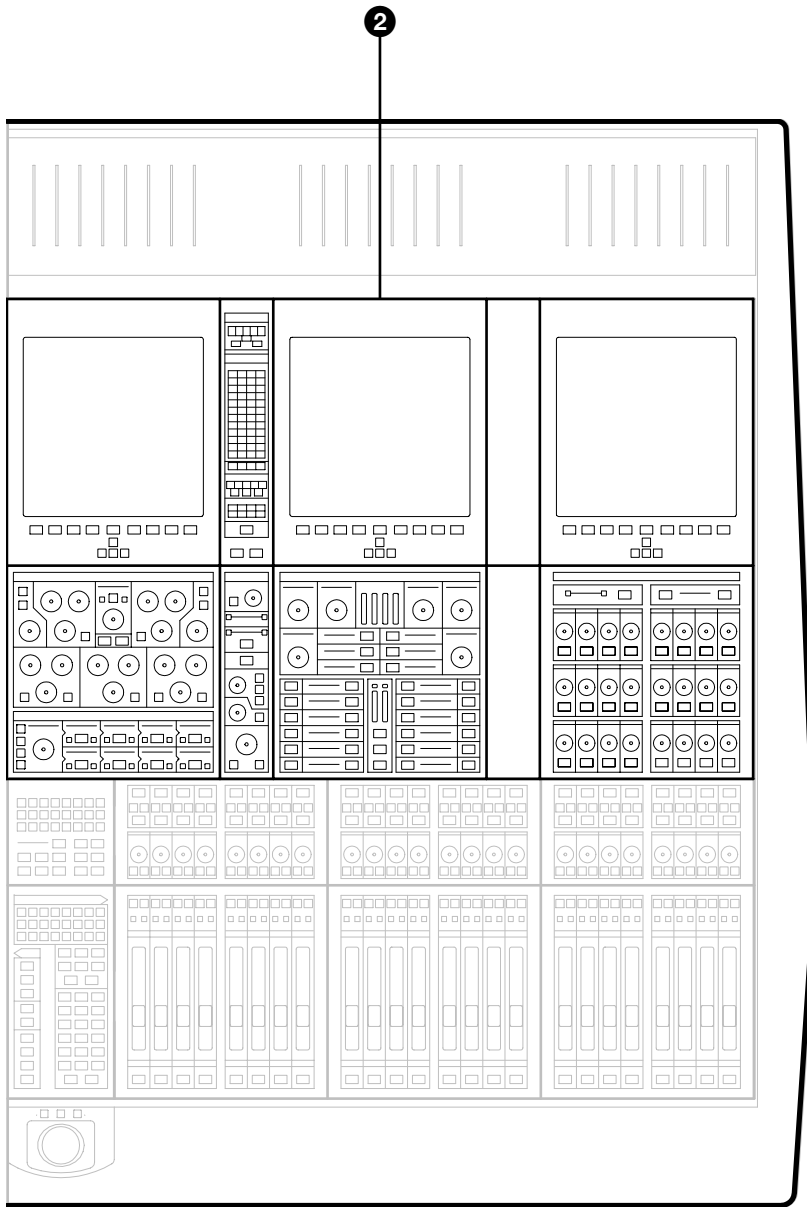

# 3-1 The Control Surface

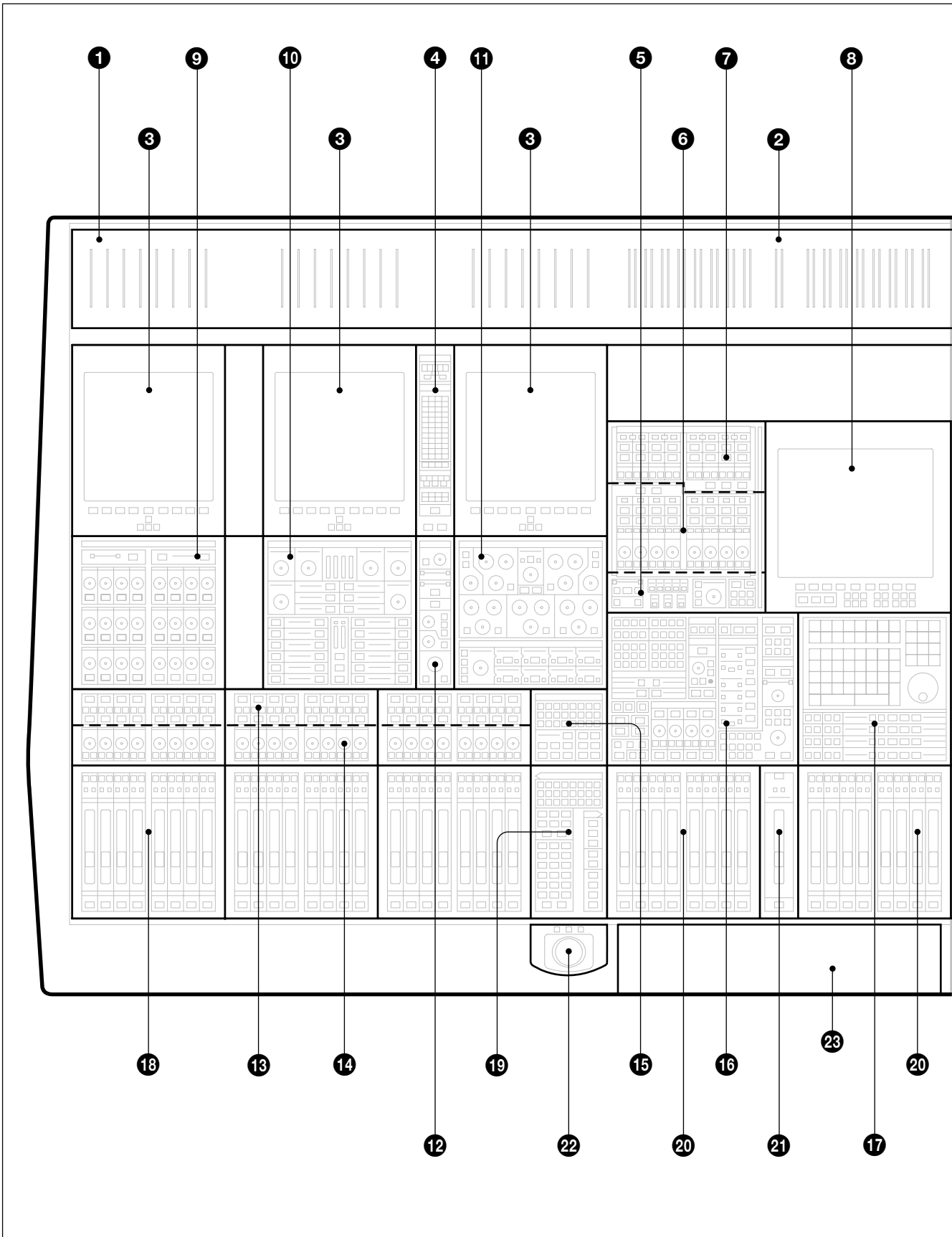

OXF-R3 panel locations

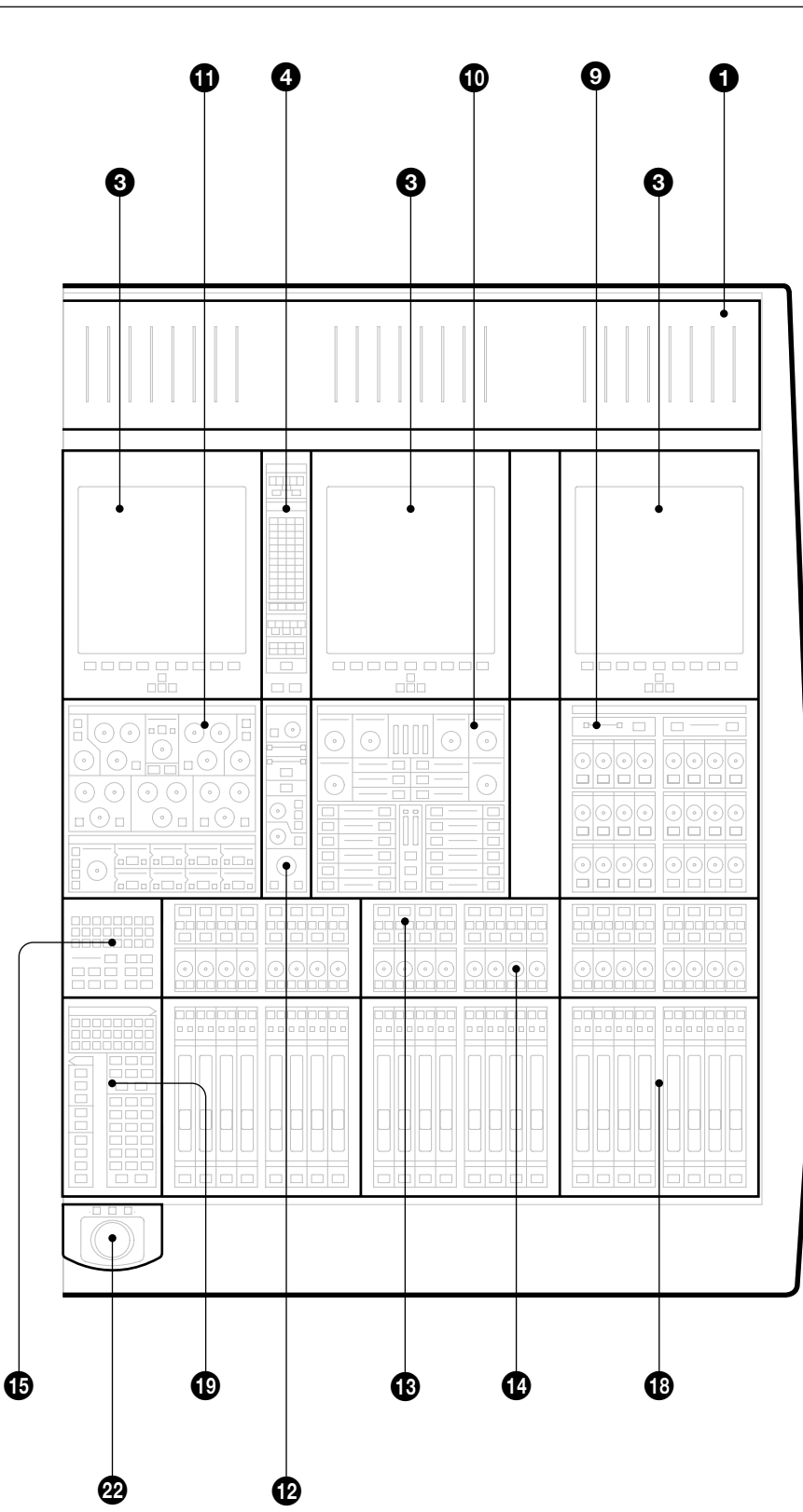

- 1 Meter Bridge – Mono Meters
- 2 Meter Bridge – Stereo Meters
- 3 Channel Screens (6)
- 4 Routing Panels
- 5 Multi-Channel Set-up Panel
- 6 Super Send Group Masters
- 7 Sends Masters
- 8 Central Control Screen
- 9 Sends Panels
- 10 Free Assign Area/Dynamics Panels
- 11 Input & Equaliser Panels
- 12 Multitrack Panels
- 13 Track Monitoring Controls
- 14 Assignable Pan Knobs
- 15 Select to Pans Panels
- 16 Monitor & Foldback Panel
- 17 Control Keyboard & Automation Controls
- 18 Assignable Channel Faders
- 19 Select to Faders Panels
- 20 Multi-Purpose Faders
- 21 Main Output Fader
- 22 Trackerballs
- 23 QWERTY Keyboard (beneath sliding cover)

## 3-2 Fader Paging

The OXF-R3 has 48 (or 24 on a 24-C-0) channel faders on its control surface but Fader Paging enables control of a much greater number of channels. Fader Paging allows banks of 24 channels to be selected on either side of the centre section at any time. The diagram illustrates how Fader Paging relates to a standard in-line console. Use the **SELECT TO FADERS** panel to select the fader bank required. Within that panel, there are a number of buttons marked CHS 1-24, CHS 25-48 and so on. There is a **SELECT TO FADERS** panel for each set of 24 channel faders, left and right of the centre section.

### 96 CHANNEL IN-LINE CONSOLE

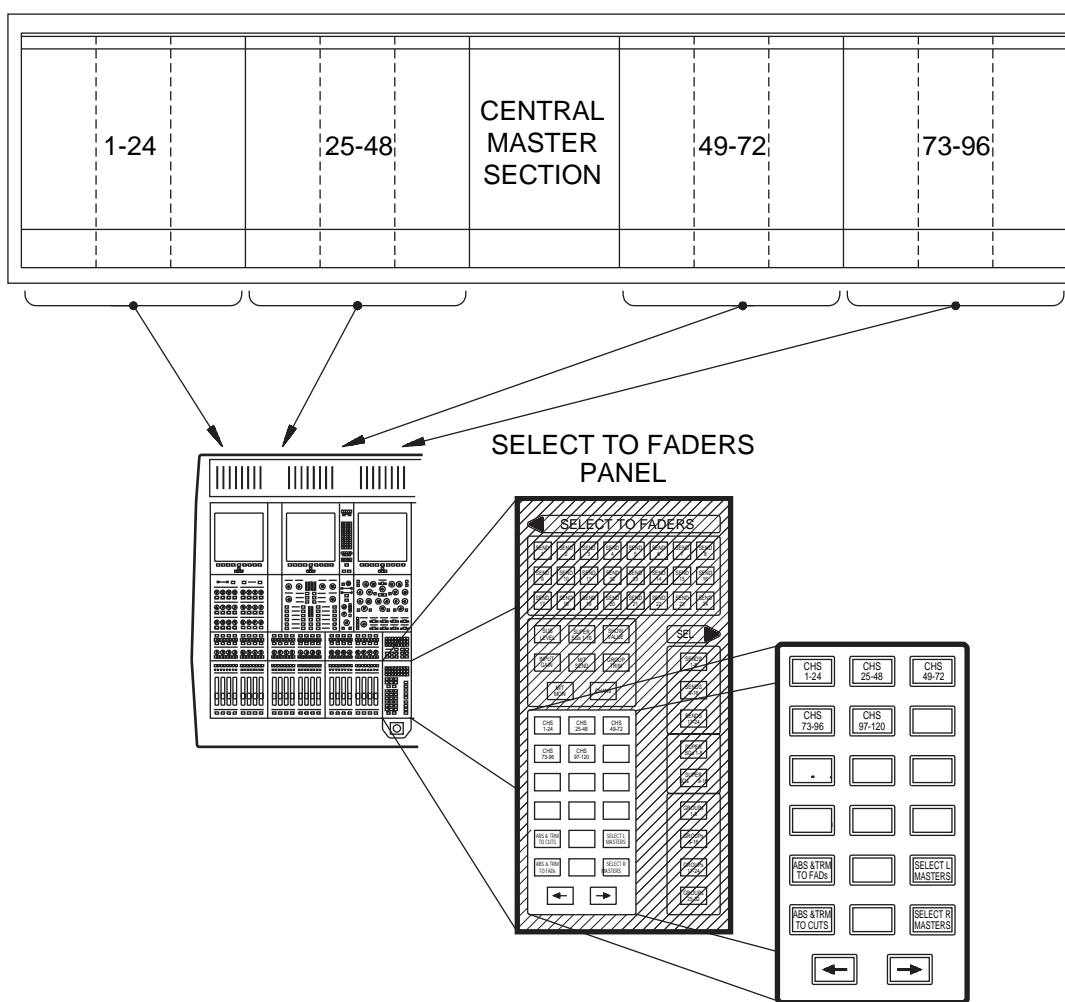

Paging of Faders for the left side of the control surface

# 3-3 Assignable Channel Processing

Once the appropriate bank of 24 channel faders is selected, individual channel controls can be adjusted. To do this, press the **ACCESS** button below the fader for the channel required. Then all the **ASSIGNABLE PANELS** belong to that channel, displaying its settings. Adjust as necessary.

As can be seen from the diagram, the functions on an in-line vertical channel strip become horizontal on the OXF-R3. In other words, the whole panel is equivalent to an exceptionally comprehensive channel strip. This is assigned to each channel individually, simply by pressing the appropriate channel **ACCESS** button.

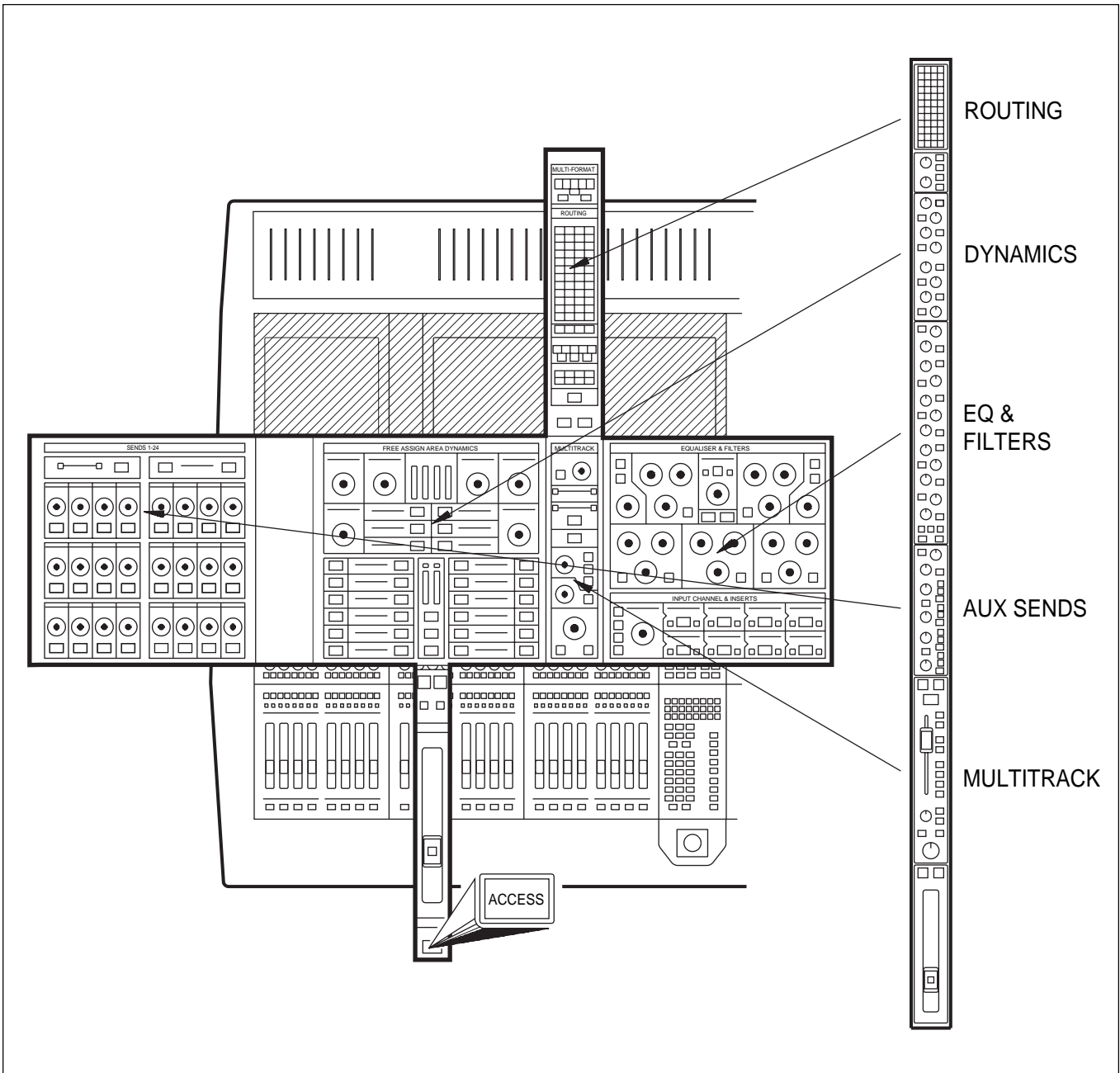

Assignable panels

# 3-4 Input Channel, Equaliser and Filters

The Input Channel section is much more flexible than a conventional in-line analogue channel strip in that it allows processing elements to be configured in almost any order. The eight boxes towards the bottom of the panel enable up to eight functions to be placed in each channel path with individual IN switches. The order of the processes can be totally different on every channel, as desired.

The 5 Band Equaliser and High & Low Filters sections are independent and can be assigned separately within the channel signal path. To view parameters and curves whenever EQ and Filters are in use, access the EQ page available on the channel screens.

Various EQ options are available which are selected using the **IN** and **+ / -** buttons situated in the upper middle section of the panel.

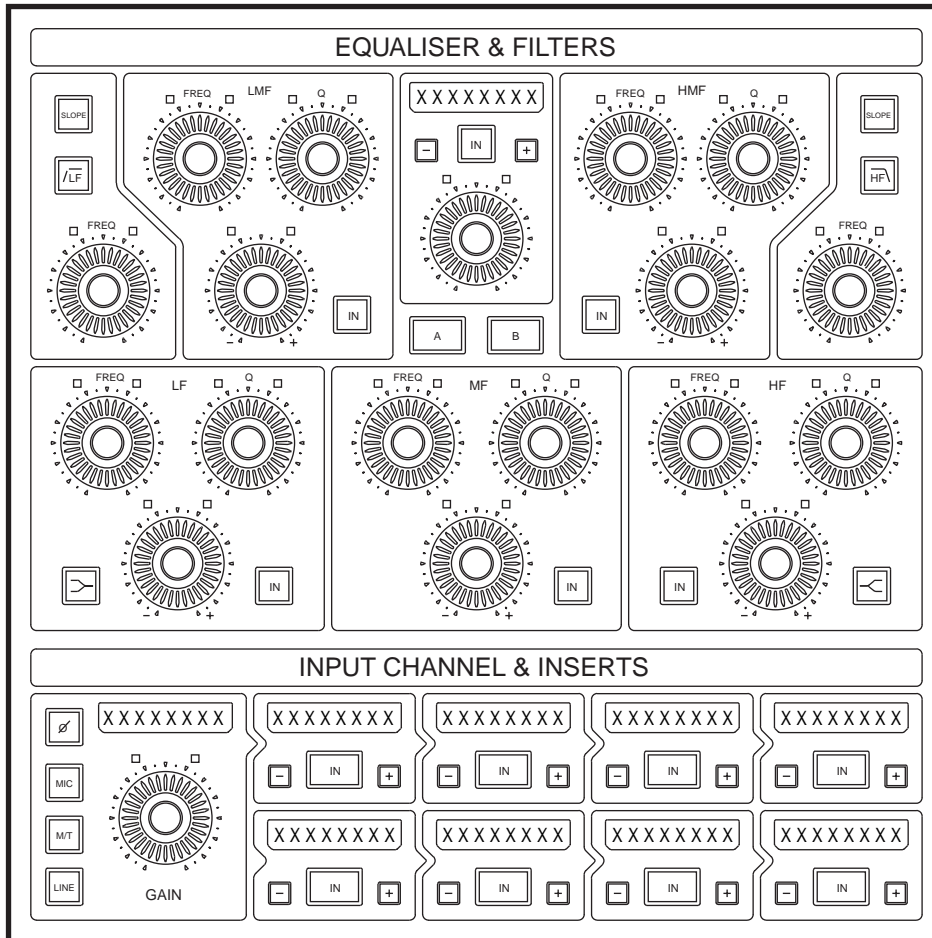

Input Channel & Inserts, Equaliser and Filters panel



## 3-5 Free Assign Area and Dynamics

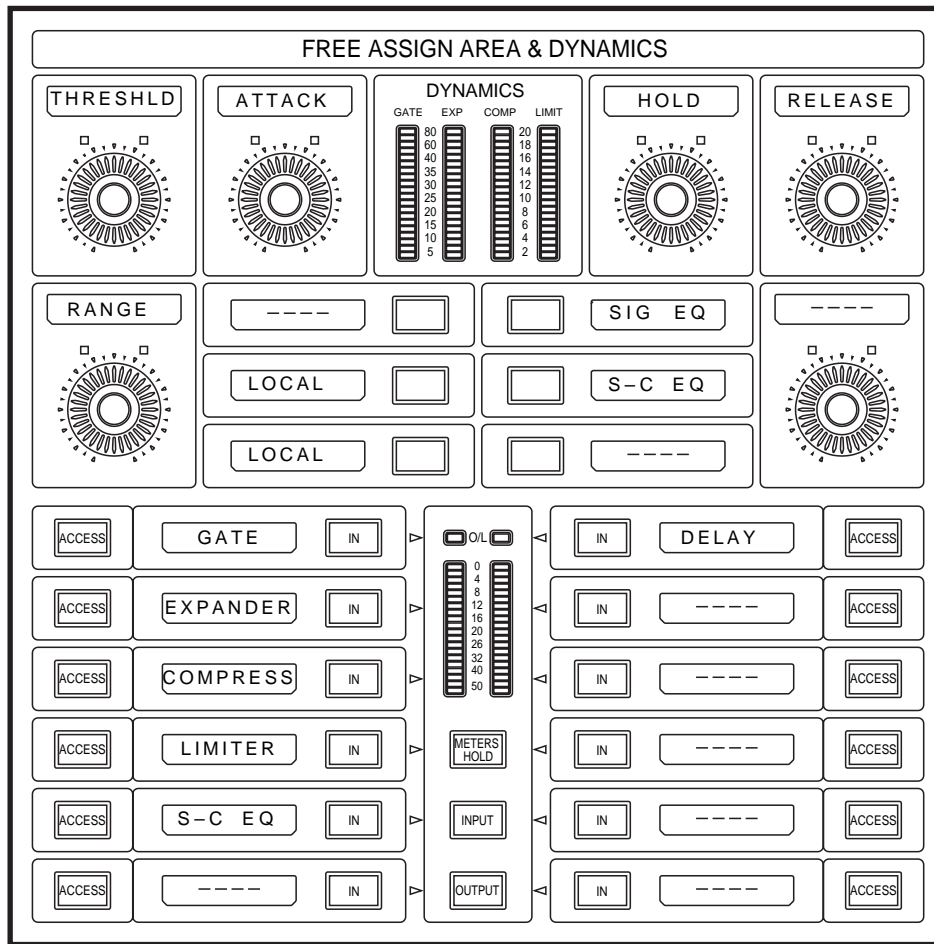

Free Assign Area & Dynamics panel

The Dynamics function area (lower left) contains:

- GATE
- EXPANDER
- COMPRESSOR (there are a number of Compressor options)
- LIMITER
- SIDE-CHAIN EQUALISER (S-C EQ).

Each section of the Dynamics has its own side-chain and allows very comprehensive control, equivalent to that of high specification units. All four side-chains operate on a single gain control element. The Side-Chain EQ is a fully parametric 2-band element which may be inserted in three ways:

- in the Dynamics Side-Chain only
- in the Signal Path only as a second EQ
- in the Signal Path and the Side-Chain.

The current Free Assign Area (lower right) contains:

- DELAY Effect

This area includes space for additional effects as and when software upgrades are introduced in the future.

# 3-6 Multitrack, Routing for Multitrack, Super Send Groups and Multi-Format

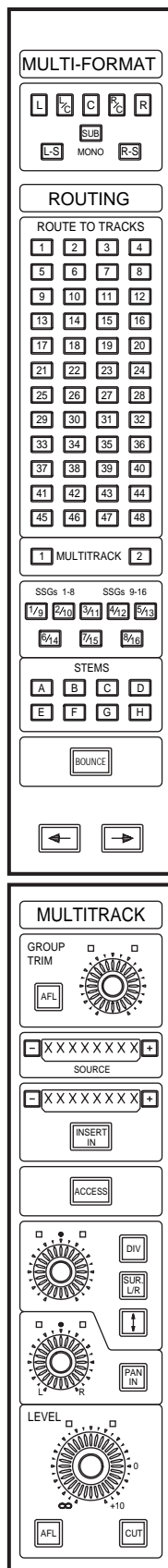

Routing for Multitrack, Super Send Groups & Multi-Format and Multitrack panels

## MULTI-FORMAT Buttons

These routing buttons have a layout matching a set of 7.1 surround LS. Their function depends on what is selected to the faders at the SELECT TO FADERS panel. In other words, they set the destinations for the signals currently passing through the faders.

## ROUTING Buttons 1-48, (GRP) & (DIR)

Two sets of buttons on each side of the console allow channel sources to be assigned to Multitrack Group Busses 1-48 ((GRP) - default) or Direct Outputs ((DIR) ). The routing for 48 channels can be displayed simultaneously by showing 8 channels on each of the associated six channel screens, three per side. The screens display further channels automatically, consistent with fader paging.

## SSGs 1-8 & SSGs 9-16

These buttons allow post channel fader and pan feeds to Super Send Groups 1-16. They are paged and legends lit depending on whether (SUPERSGs1-8) or (SUPERSGs9-16) is selected in the centre section.

## STEM Selectors (A) - (H)

These buttons are operational in Multi-Format Mode to assign channel outputs to stems set up on the multitrack busses.

## (BOUNCE) Push-Button

Redirects the output of a channel from the Main Output Bus to the multitrack routing buttons in the MULTITRACK section for bounce-down purposes. One of the stems A-H must be selected to bounce down a surround source or a signal with surround panning.

## MULTITRACK

This panel contains controls related to the multitrack except individual track remotes and monitor switching. These are above the pan controls in line with their equivalent number channel faders. All level controls can be assigned to faders. Surround panning is available at this panel in parallel with the joysticks and individual pans above the faders. These pan controls are operational on what is selected to the faders at the SELECT TO FADERS panel.

The OXF-R3 allows the multitrack to be used 'in-line' for normal record/remix work or 'on-the-side' where a live mix requires a multitrack backup. A separate stereo monitor bus is included specifically for monitoring the multitrack when used in parallel with a live mix.

# 3-7 Sends

There are currently 24 mono Sends that can be linked as odd/even pairs, set up at the **SEND OUTPUTS 1-24** panel in the centre section, to provide up to 12 stereos. The levels to the busses can be set via the individual dedicated controls on the channels **SENDS 1-24** panels for each channel individually. Alternatively Sends can be assigned, one bus at a time, to the faders or assignable knobs (PANs). This allows a mix to an effect or foldback to be set up using the faders or a row of knobs on a console-wide basis. The source points for each Send can be set individually on each channel or on a console-wide basis.

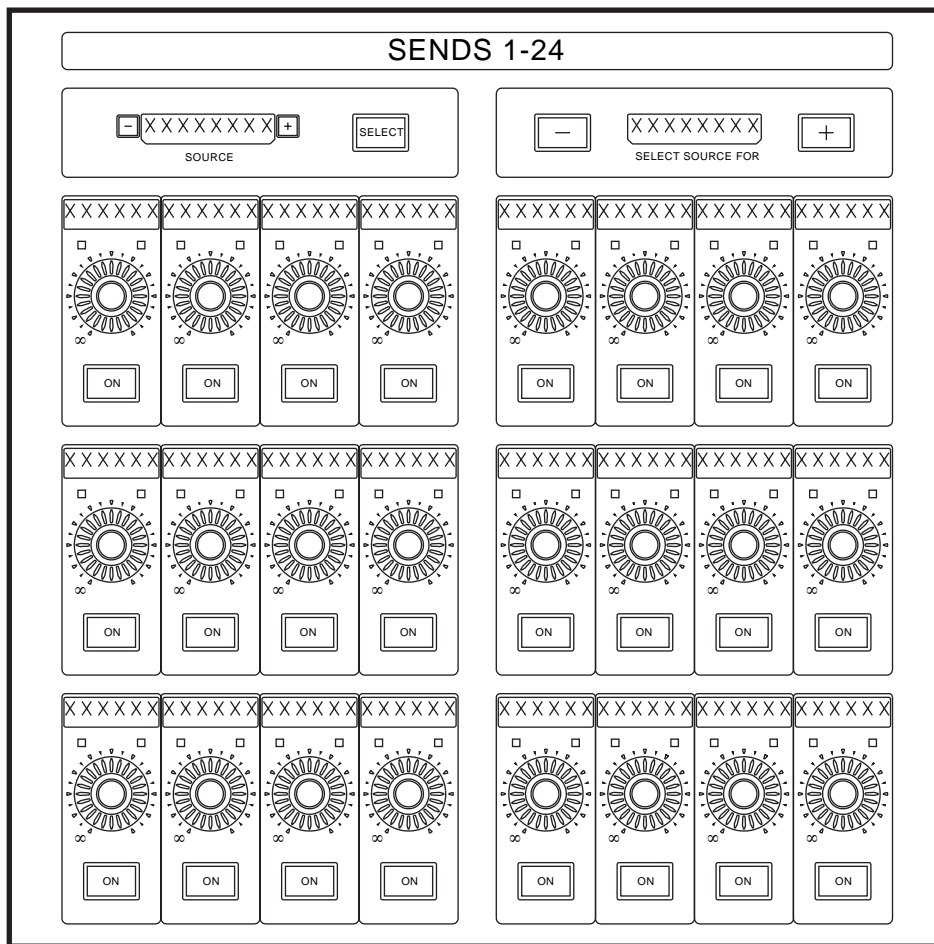

Sends 1-24 panel

## 3-8 Select To Faders

The main purpose of faders on a mixing console is to control the levels of the signals through the channels. Once a balance is achieved, the fader positions give an extremely useful graphical representation.

It is common with in-line analogue console channel strips to split the signal flow into channel and monitor paths with a fader for each. The OXF-R3 takes this concept a stage further, allowing all level and gain control to be accomplished using the faders. This is achieved by assigning the faders to all gain and level functions via the **SELECT TO FADERS** panel.

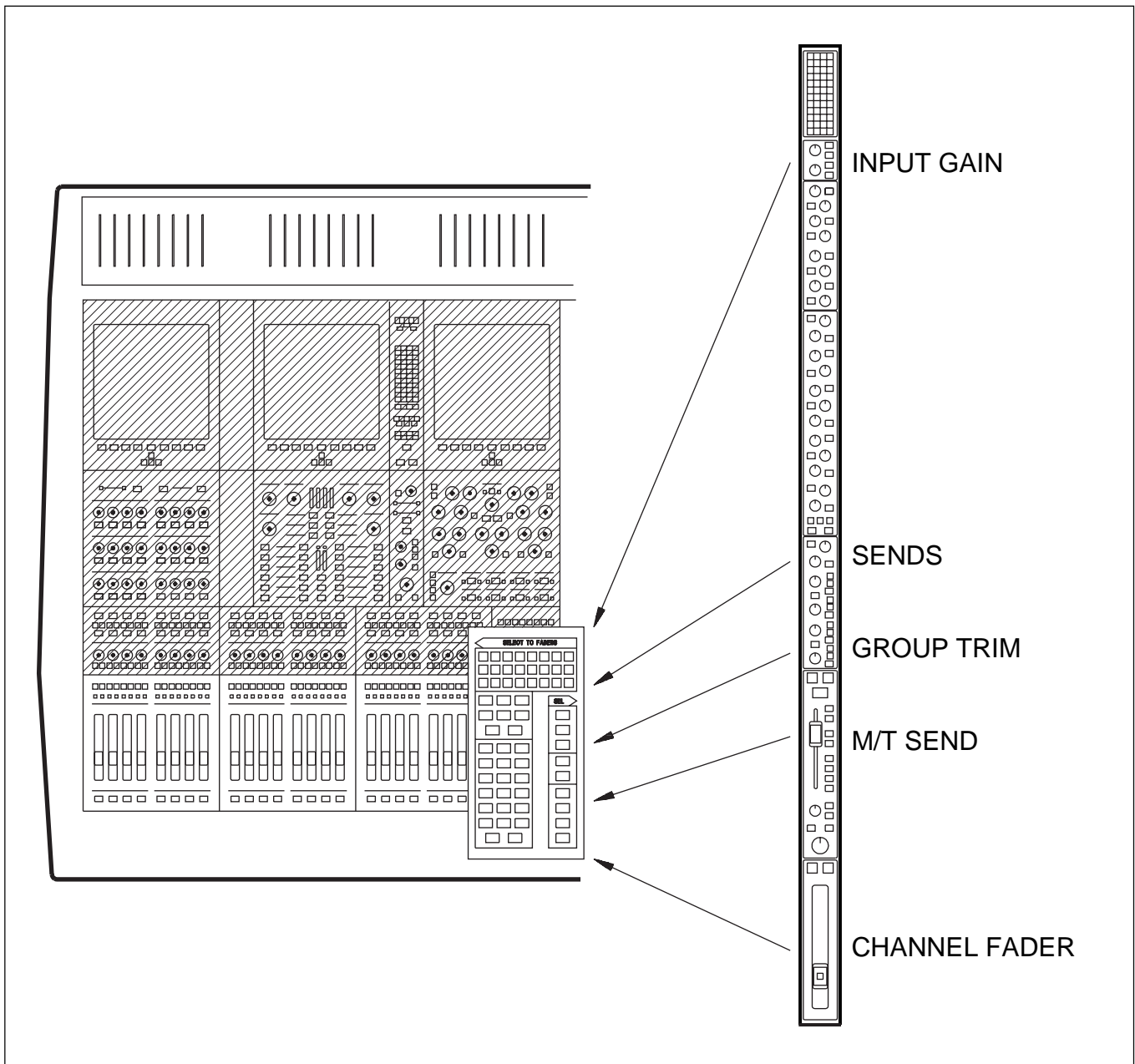

Select to Faders

As an example, on the SELECT TO FADERS panels, adjacent to the channel faders on either side of the centre section, there are buttons marked:

- 1 **CHANS**
- 2 **M/T SEND**

The default is **CHANS**, which assigns the faders to the channel outputs when they control the level to the Main Output Bus. Selecting **M/T SEND** is equivalent to selecting the ‘small fader’ function to the OXF-R3 faders. The combined use of Fader Paging and the Select to Faders functionality allows control of all channel level functions, using the 48 conveniently placed, high quality faders in the left and right channels sections.

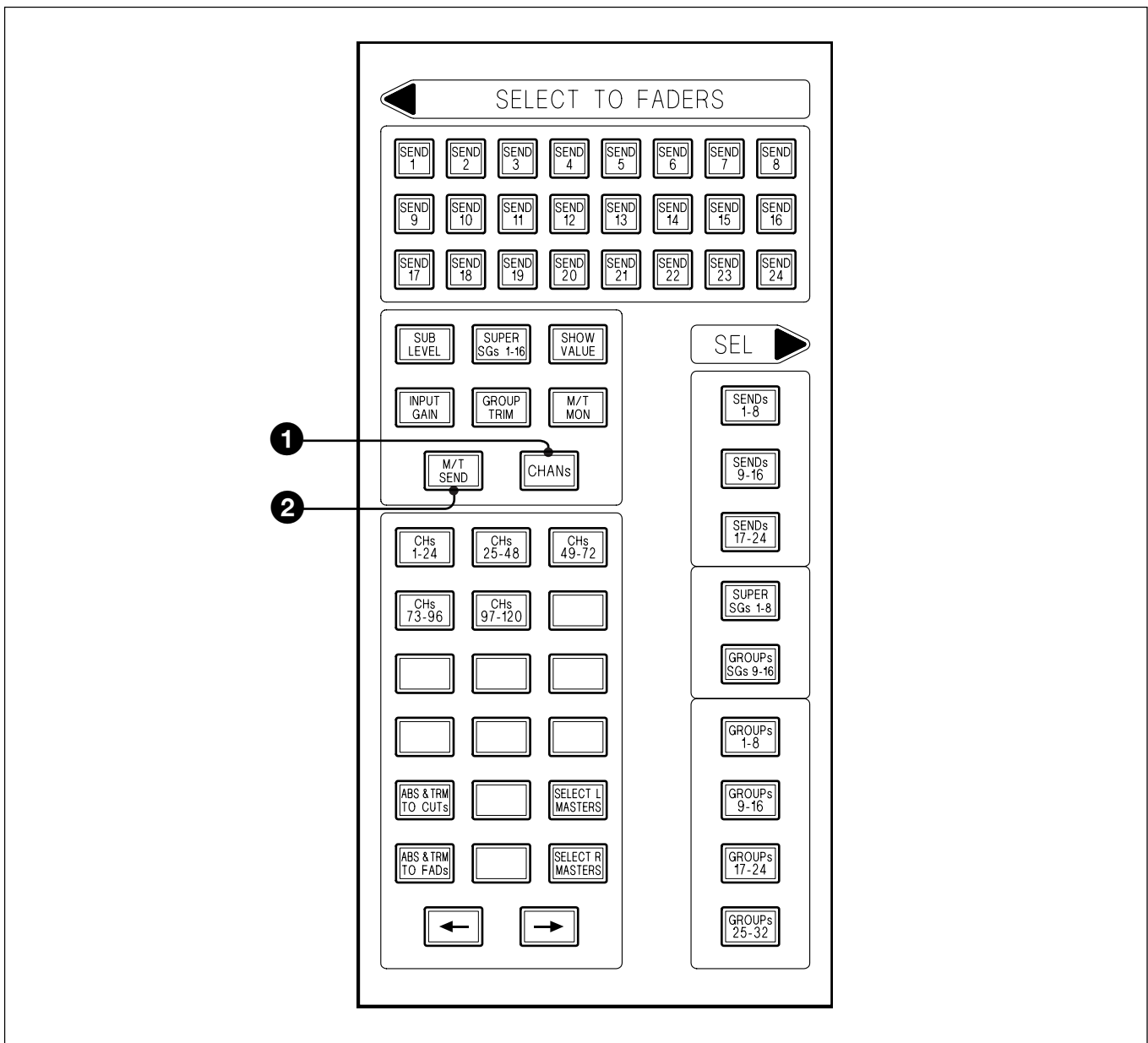

Select To Faders panel layout

## 3-8 Select To Faders

---

Exploiting this approach even further, the faders can also be assigned to control Input Gain, Group Trim and all Send Bus levels.

The Select to Faders diagram at the beginning of this section is a visual guide showing how the OXF-R3 accommodates conventional in-line channel strip level controls on its faders. Note that all level controls are still available in parallel within the assignable panels in a more conventional manner.

This approach is very convenient for checking foldback or effects send balances. The faders and their selector system are very close at hand, allowing any balance to be quickly checked at a glance and adjusted.

A copy function allows the user to take the balance set-up as the monitor mix and transfer it to any of the Send Bus mixes. The fader balance copy function applies to M/T Send Faders to Channel Faders and vice versa. This is described in detail in Chapter 6.

The 16 centre section master faders are also assignable in two groups of 8 faders. They are assigned via the **SEL** area on the SELECT TO FADERS panel and may control:

- **SENDS** (Send Master levels)
- **SUPER SGs** (Super Send Group master levels)
- **GROUPs** (VCA style control group masters)

## 3-9 Select To Pans

The Pan Knobs above the faders are assignable in a similar manner to the faders. Although their primary job is panning, they can also be used to perform all channel level adjustments, such as input gain settings and Send Bus levels. They are really Definable Knobs rather than just Pans.

As can be seen in the diagram below, the SELECT TO PANS panel performs a function for the Pans similar to that of the SELECT TO FADERS panel for the faders. All equivalent level and gain control functions, on an in-line channel strip, may be assigned to the row of Definable Knobs whose default setting is channel Pan.

A typical set-up could have Mic Gain controlled by the knobs, whilst the faders control the M/T Send. With this set-up, all levels are easily adjusted during tracking. Remember that dedicated knobs are always available on the assignable panel areas in parallel for all level controls.

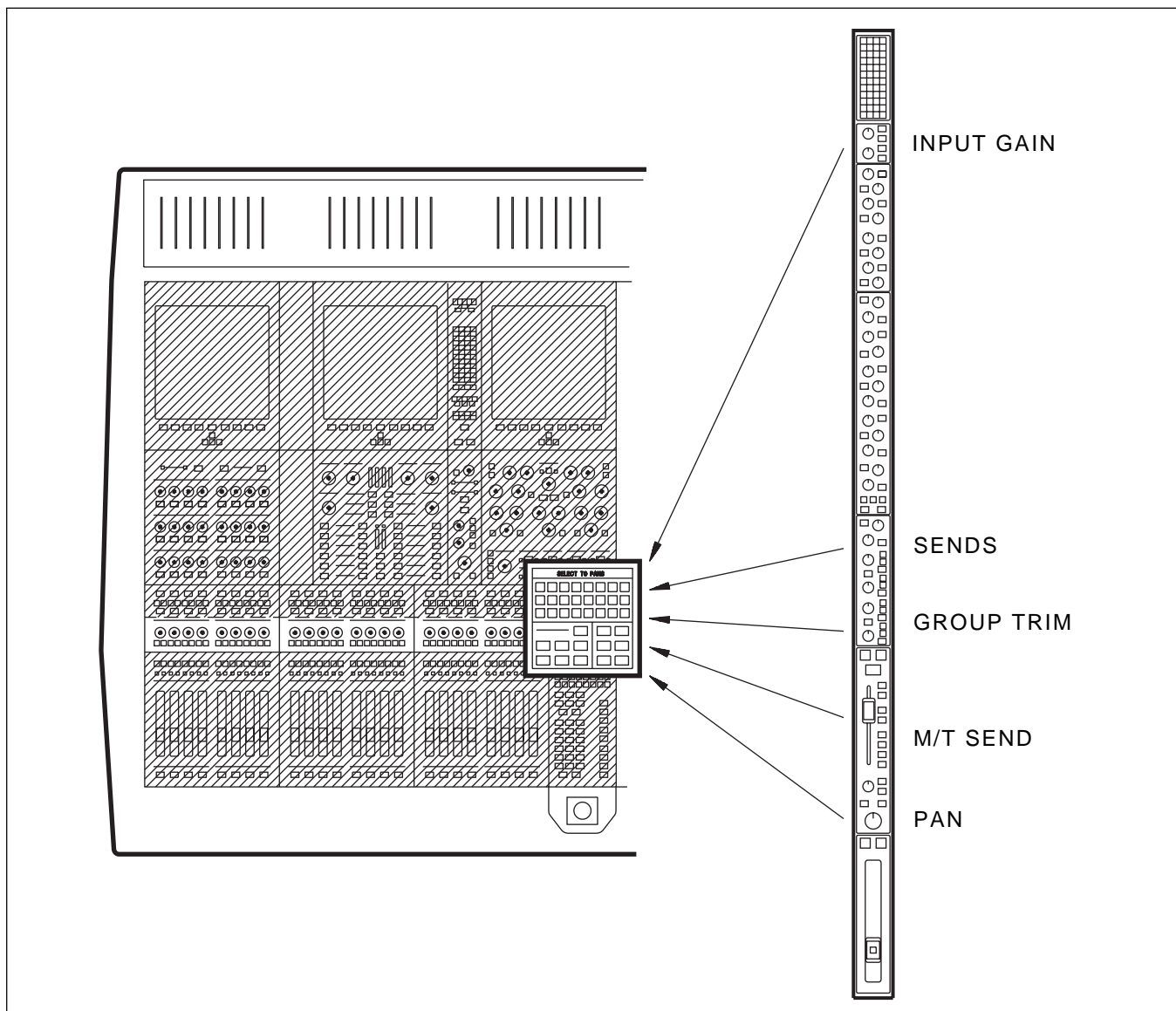

Select to Pans

## 3-10 Basic Console Operations

### General

The following series of illustrations and brief step by step procedures are designed to allow new OXF-R3 operators to begin using the console in a very short space of time, without having detailed knowledge of the system.

### System Set-up

The examples shown assume that signal sources, such as microphones, line level signals and multitrack or hard disc recorder, are already connected and routed to appropriate inputs, with machine control in place. They also assume that the control room monitor LS are hooked up to the OXF-R3 system.

### Main Bus Set-up

The Main Output Bus can be set for the following 'widths': Stereo, LCRS, 5.1 and 7.1. For the purposes of the examples, the fire-up default of Stereo will be assumed.



### 3-10-1 To Route a Mic or Line Input to the Main Output Bus

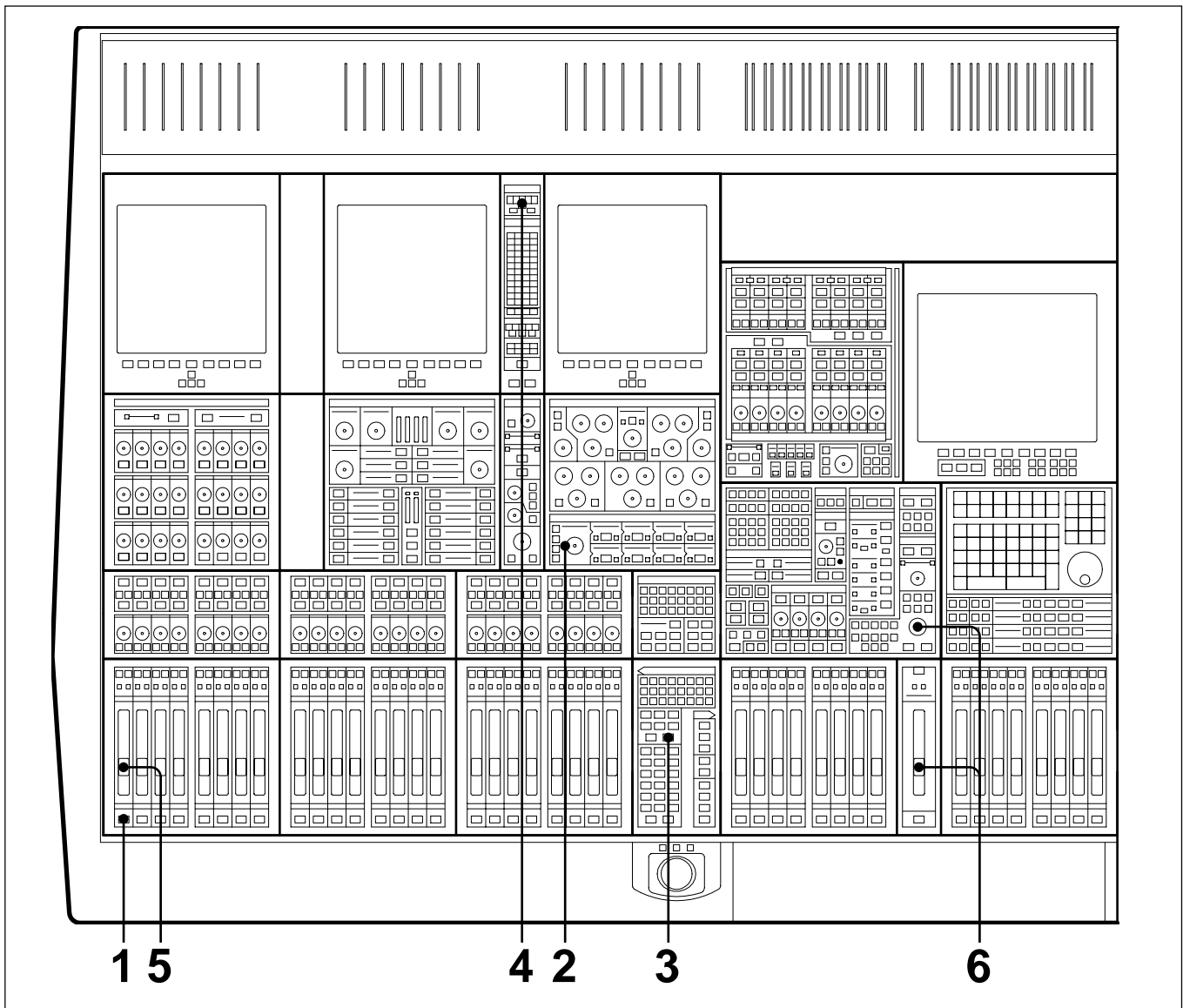

- 1** Press **ACCESS** for the desired Channel.
- 2** At the Input Channel & Inserts panel, press either **MIC** or **LINE** as required, and set the input **GAIN** knob to a suitable setting.
- 3** Make sure **CHANS** is selected on the Select To Faders panel (fire-up default).
- 4** At the Routing panel, select **L** and **R** (fire-up default) if not already lit.
- 5** Adjust the level to the Main Output Bus with the Channel Fader.
- 6** Open the Main Fader and turn up the CR Monitor level.

## 3-10 Basic Console Operations

### 3-10-2 To Set Up a Super Send Group from Channel Inputs

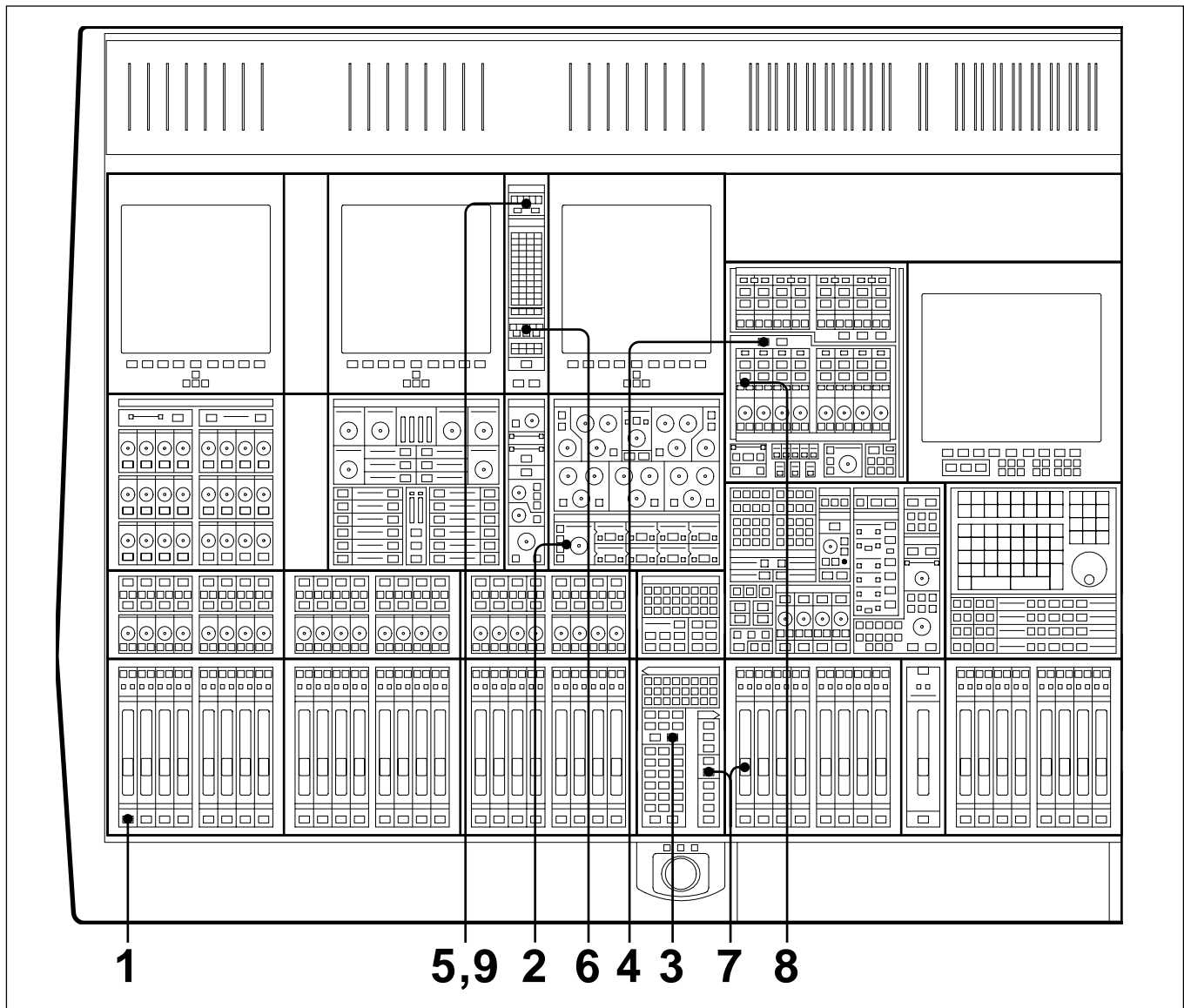

- 1 Press **ACCESS** for the first Channel to be routed to a Super Send Group (SSG).
- 2 Select **MIC** or **LINE** as required. Set the gain.
- 3 Make sure **CHANS** is selected on the Select To Faders panel (fire-up default).
- 4 Make sure **SUPER SGs 1-8** is selected in the SSG masters section.
- 5 At the Routing panel, de-select **L** and **R**.
- 6 At the same panel, select the SSGs required, **1/9** and **2/10** in this case.
- 7 At the Select To Faders panel (SEL section), select **SUPER SGs 1-8**, then adjust the Fader to 0dB in the Central Faders panel.
- 8 Above the SSG 1 level knob select **MAIN** and its **ACCESS**.
- 9 At the top of the Routing panel select **L**.
- 10 Repeat steps 7 and 8 for SSG 2 but select **R** at the Routing panel.
- 11 Repeat steps 1 to 6 for further channels.

### 3-10-3 To Send Signals to Tracks on Tape

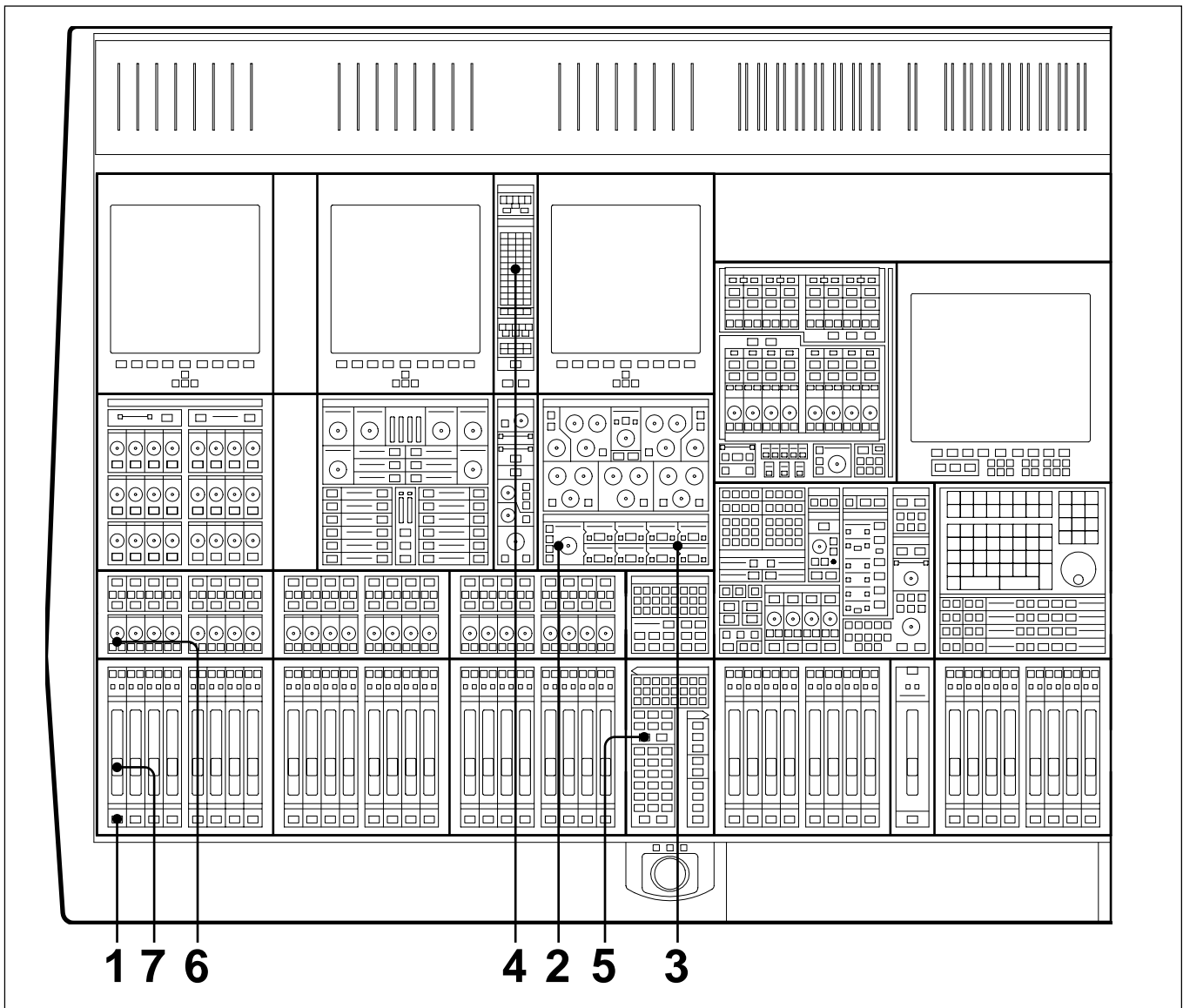

- 1** Press **ACCESS** for the desired Channel.
- 2** At the Input Channel & Inserts panel, press either **MIC** or **LINE** as required, and set the input **GAIN** knob to a suitable setting.
- 3** At the same panel, select 'MULTI' in one of the eight windows. Do this using the **+** and **-** buttons, and then press the large **IN** button.
- 4** At the Routing panel, select the tracks required in the **ROUTE TO TRACKS** section. The Pan works across odd and even numbers in Stereo.
- 5** On the Select To Faders panel, press **M/T SEND**.
- 6** To pan between tracks, press **CUT**, if it is lit which sets the pan into operation, and adjust the Pan Knob accordingly.
- 7** Adjust the level to tape using the Fader. Check the meter level for the track to which the signal is routed.

## 3-10 Basic Console Operations

### 3-10-4 To Monitor Signals To and From Tape

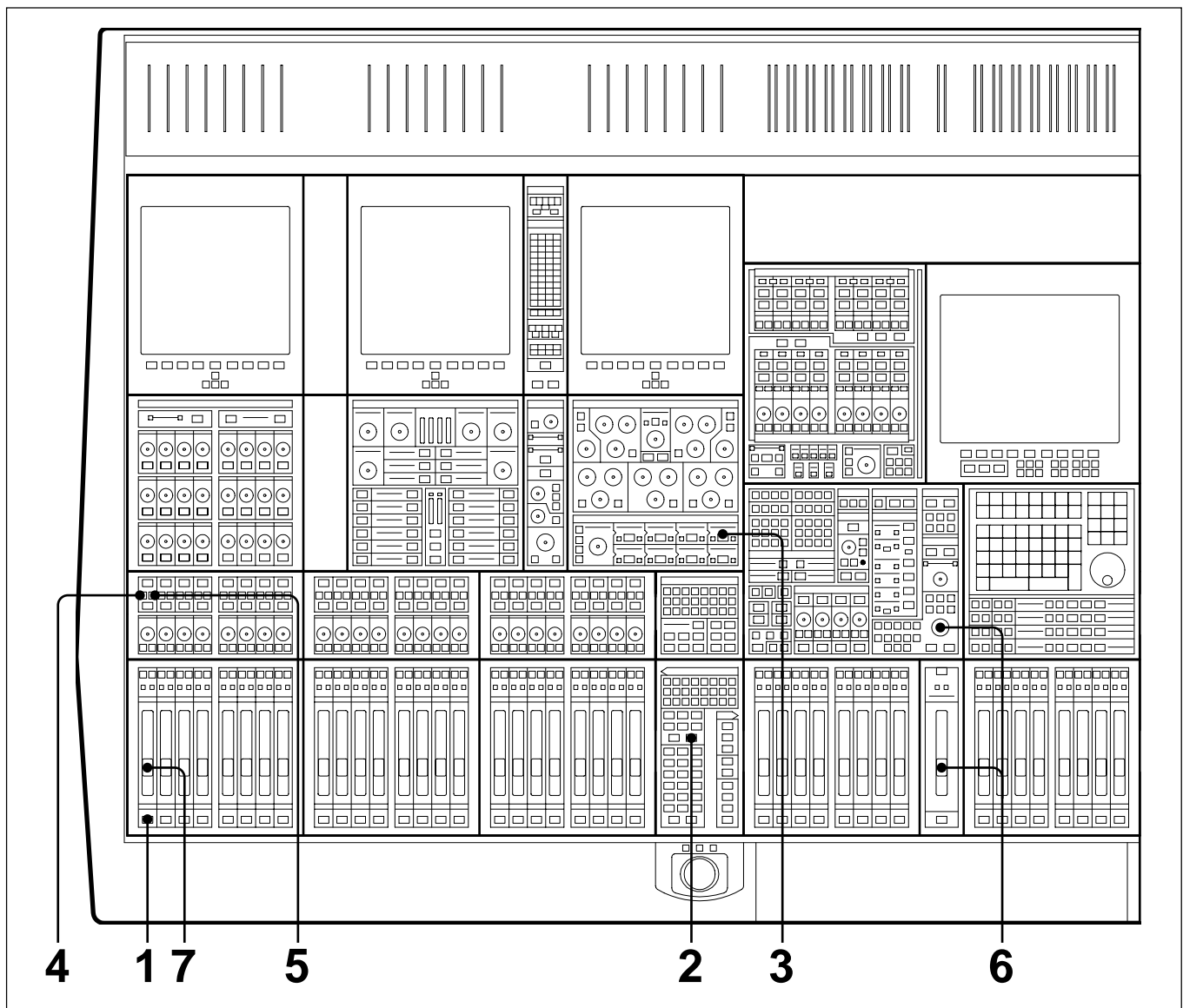

- 1 Press **ACCESS** for the desired Channel.
- 2 Select **CHANS** on the Select To Faders panel (fire-up default).
- 3 At the Input Channel & Inserts panel, select 'MULTI' in window number 4 using the **+** and **-** buttons either side. Select its large **IN** button to insert the multitrack into the signal path.
- 4 At the Pans panel, press **SEND** to select the signal being fed to tape
- 5 Or press **SEND** to select the signal from tape.
- 6 Open the Main Fader and turn up the CR Monitor level.
- 7 Use the Channel Fader to adjust monitor level via the Main Output Bus.

### 3-10-5 To Set Up a Stereo Headphone Mix for Foldback 1 O/P

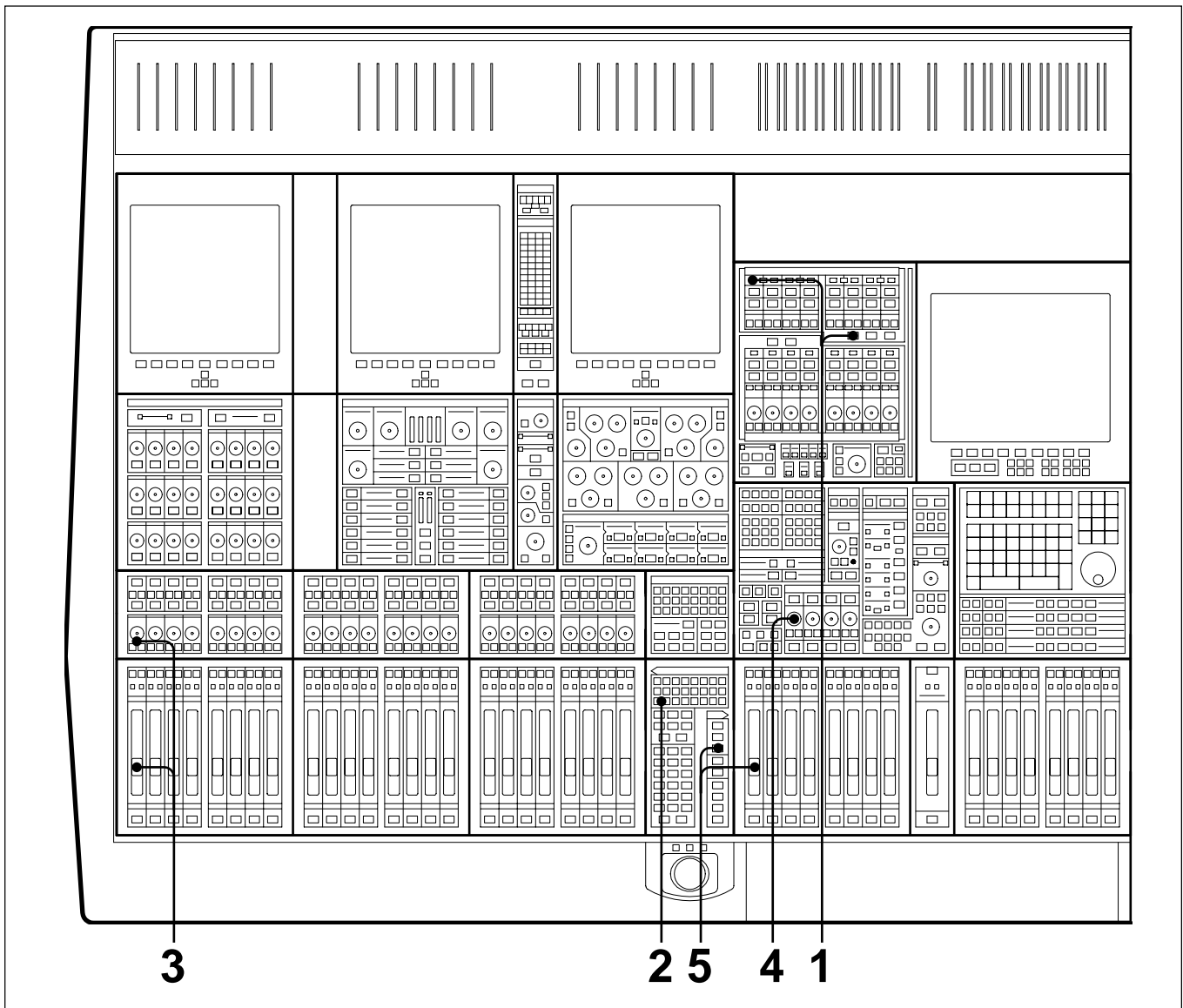

- 1 At the Send Outputs 1-24 panel in the console centre section, select **[17-24]** and then select **[STEREO]** between Send Masters 17 and 18. Sends 17 and 18 are a dedicated assignment to Stereo Foldback 1. Select **[AFL]** to audition the balance.

**Note:**

Send Masters 19 and 20 are assigned to Stereo Foldback O/P 2; 21 and 22 to Foldback 3; 23 and 24 to Foldback 4.

- 2 At the Select To Faders panel, select **[SEND 17]** or **[SEND 18]**. Pressing either will light both.
- 3 Turn off the **[CUT]** buttons and set up the balance and pan positions using the Faders and their Pans. Turn off the Pan **[CUT]** if necessary.
- 4 At the Foldback Groups 1-4 section, located in the central Monitor panel, adjust the LEVEL pot for a suitable level in the headphones. (Make sure **[CUT]** is not lit) Use the **[T/B F/Back 1]** button to talk to the artist(s).
- 5 The bus level itself, which defaults to unity gain, can be adjusted using the central faders. On the Select To Faders panel, SEL section, select **[SENDS 17-24]** and adjust Fader 17 or 18.

## 3-10 Basic Console Operations

### 3-10-6 To Equalise Signal Feeding the Multitrack

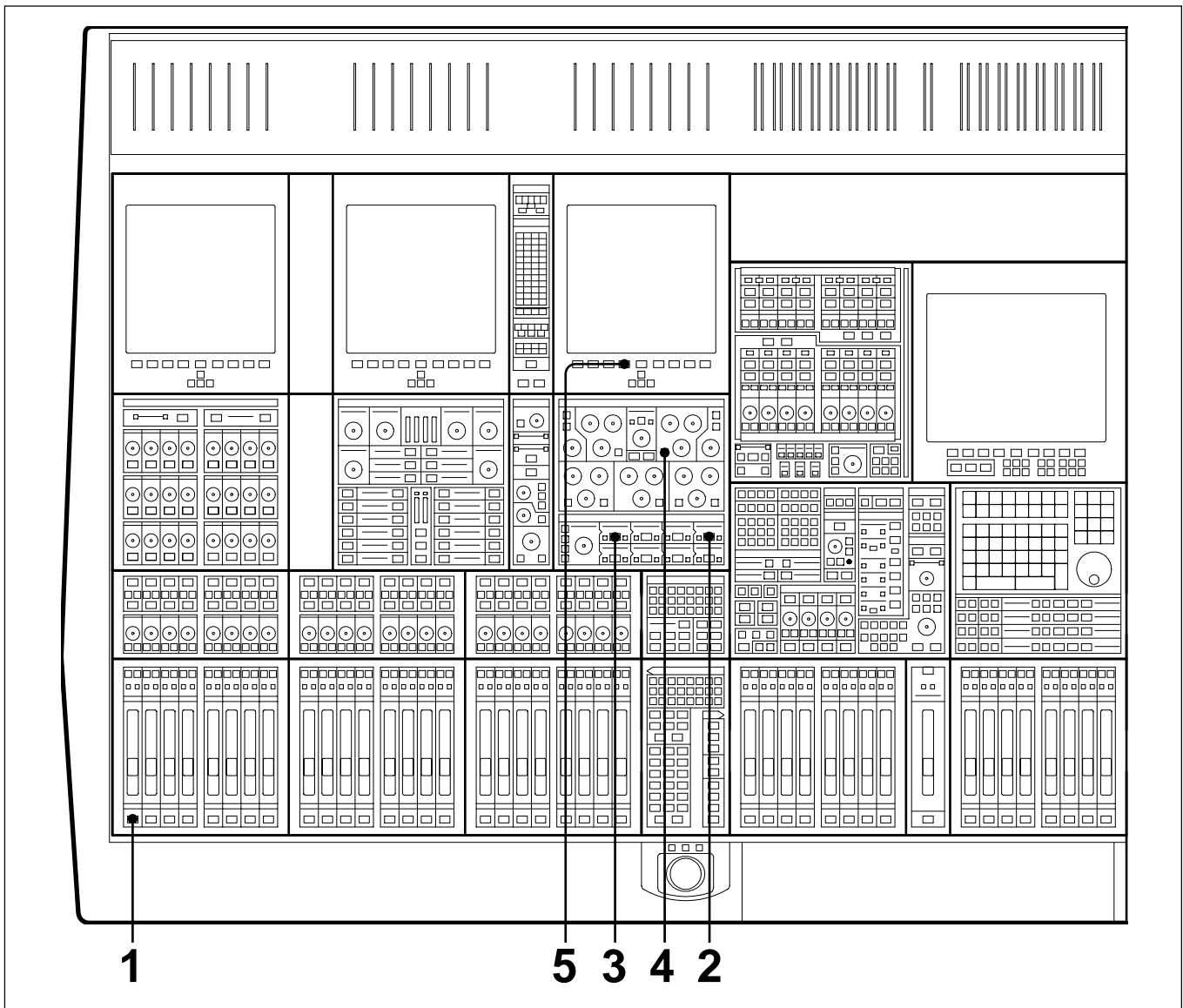

- 1 Press **ACCESS** for the desired Channel.
- 2 At the Input Channel & Inserts panel, select 'MULTI' in window number 4 using the **+** and **-** buttons either side. Select its large **IN** button to insert the multitrack into the signal path.
- 3 At the same panel, select 'EQ' in a window before window 4, window 1 for example, and select the large **IN** button to insert the equaliser into the signal path before the multitrack.
- 4 On the upper section of the same panel, select the individual **IN** buttons for the bands required and adjust as necessary.
- 5 Select the EQ softkey for the screen above the equaliser panel to view the parameters and response curve graph.

### 3-10-7 To Equalise Monitor Signal Post Multitrack

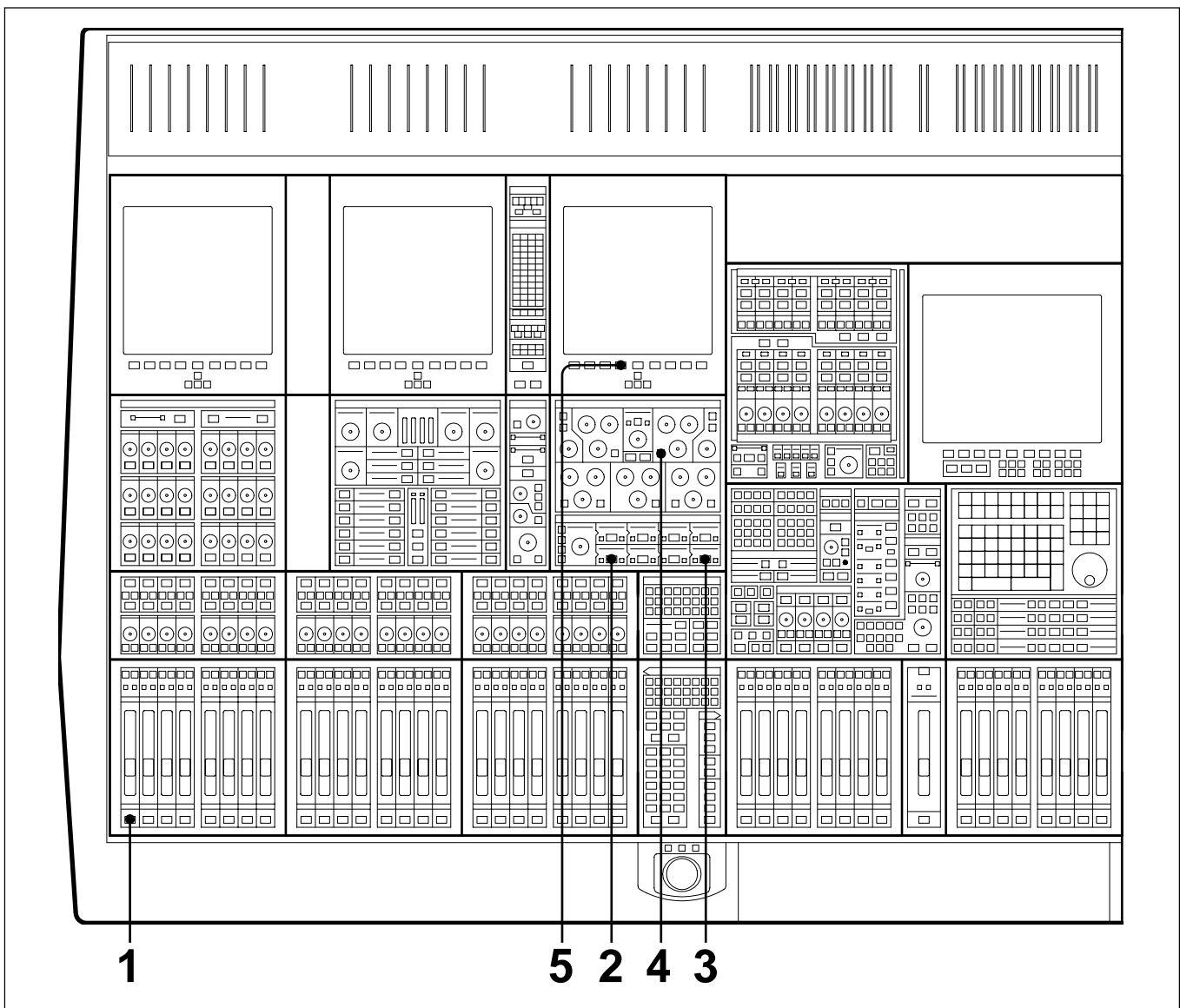

- 1** Press **ACCESS** for the desired Channel.
- 2** At the Input Channel & Inserts panel, select 'MULTI' in window number 5 using the **+** and **-** buttons either side. Select its large **IN** button to insert the multitrack into the signal path.
- 3** At the same panel, select 'EQ' in a window after window 5, window 8 for example, and select the large **IN** button to insert the equaliser into the signal path after the multitrack.
- 4** On the upper section of the same panel, select the individual **IN** buttons for the bands required and adjust as necessary.
- 5** Select the EQ softkey for the screen above the equaliser panel to view the parameters and response curve graph.

## 3-10 Basic Console Operations

### 3-10-8 To Insert Dynamics Pre Multitrack Send

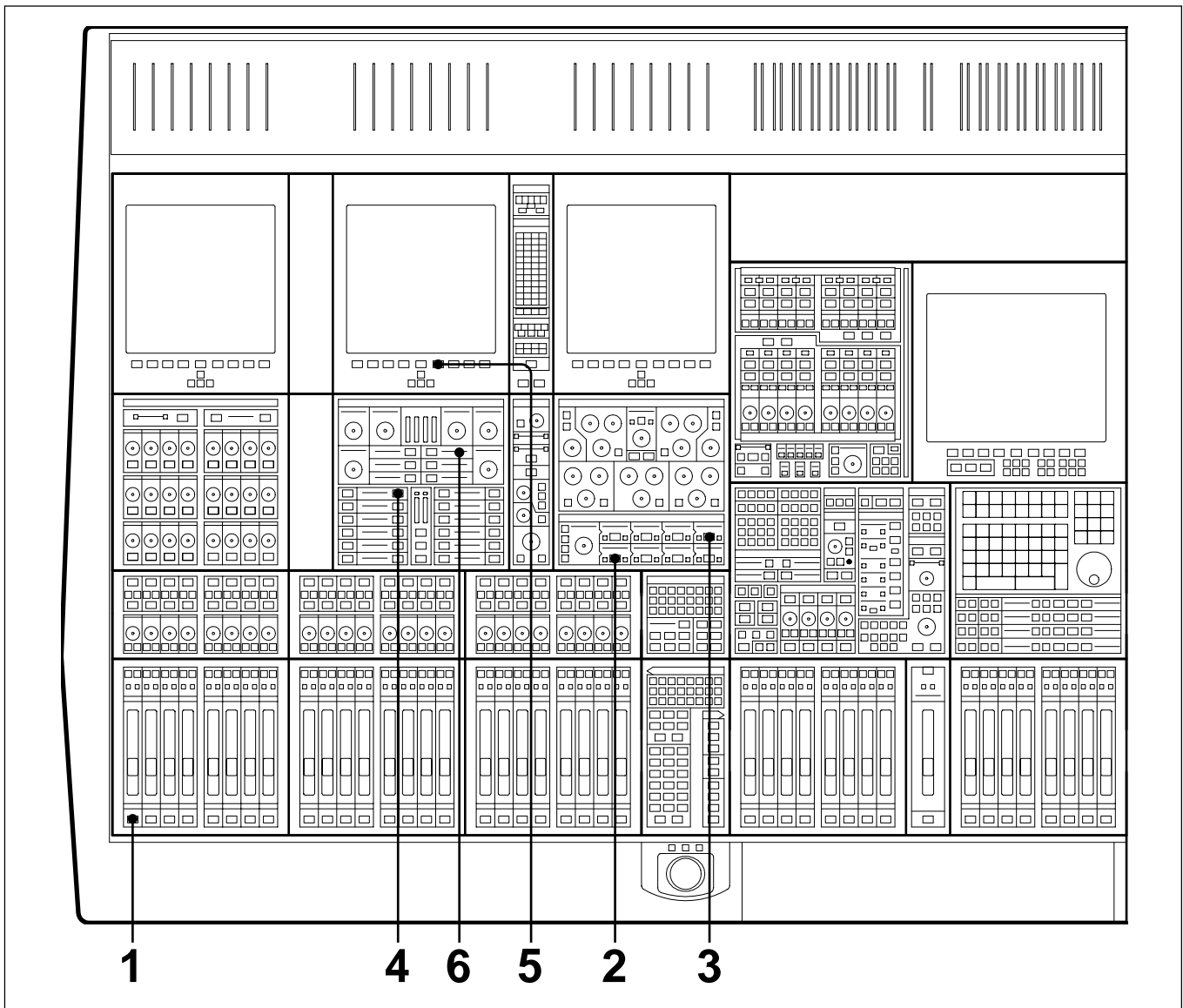

- 1** Press **ACCESS** for the desired Channel.
- 2** At the Input Channel & Inserts panel, select 'MULTI' in window number 5 using the **+** and **-** buttons either side. Select its large **IN** button to insert the multitrack into the signal path.
- 3** At the same panel, select 'DYN' in a window before window 5, window 4 for example, and select the large **IN** button to insert the dynamics processor into the signal path before the multitrack.
- 4** In the Dynamics section, located in the Free Assign Area, select **IN** buttons for the processing required: Gate, Compressor, etc., indicated by 8 character dot displays.
- 5** On the LCD screen above the dynamics controls, press the Dynamics softkey to view the parameters and transfer curve graph.
- 6** The dynamics processing is set and displayed via definable knobs and switches. Set their functions via the local **ACCESS** keys according to the processes in use. Adjust whilst viewing the settings on the LCD screen. The settings for all functions are displayed simultaneously.



### 3-10-9 To Insert Dynamics Post Multitrack Return

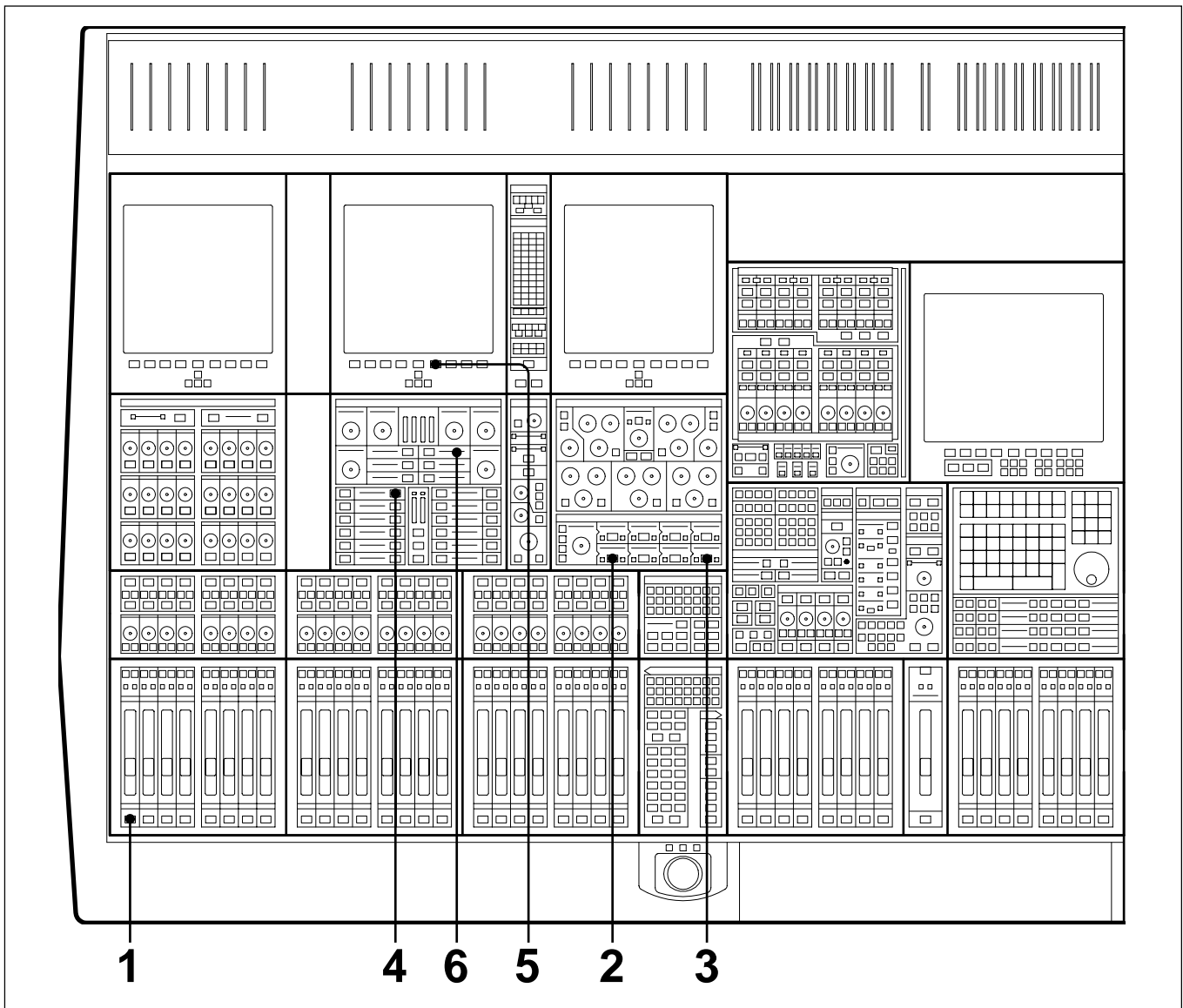

- 1** Press **ACCESS** for the desired Channel.
- 2** At the Input Channel & Inserts panel, select 'MULTI' in window number 5 using the **+** and **-** buttons either side. Select its large **IN** button to insert the multitrack into the signal path.
- 3** At the same panel, select 'DYN' in a window after window 5, window 8 for example, and select the large **IN** button to insert the dynamics processor into the signal path before the multitrack.
- 4** In the Dynamics section, located in the Free Assign Area, select **IN** buttons for the processing required: Gate, Compressor, etc., indicated by 8 character dot displays.
- 5** On the LCD screen above the dynamics controls, press the Dynamics softkey to see the parameters and transfer curve graph.
- 6** The dynamics processing is set and displayed via definable knobs and switches. Set their functions via the local **ACCESS** keys according to the processes in use. Adjust whilst viewing the settings on the LCD screen. The settings for all functions are displayed simultaneously.

## 3-10 Basic Console Operations

### 3-10-10 To Bounce Tracks

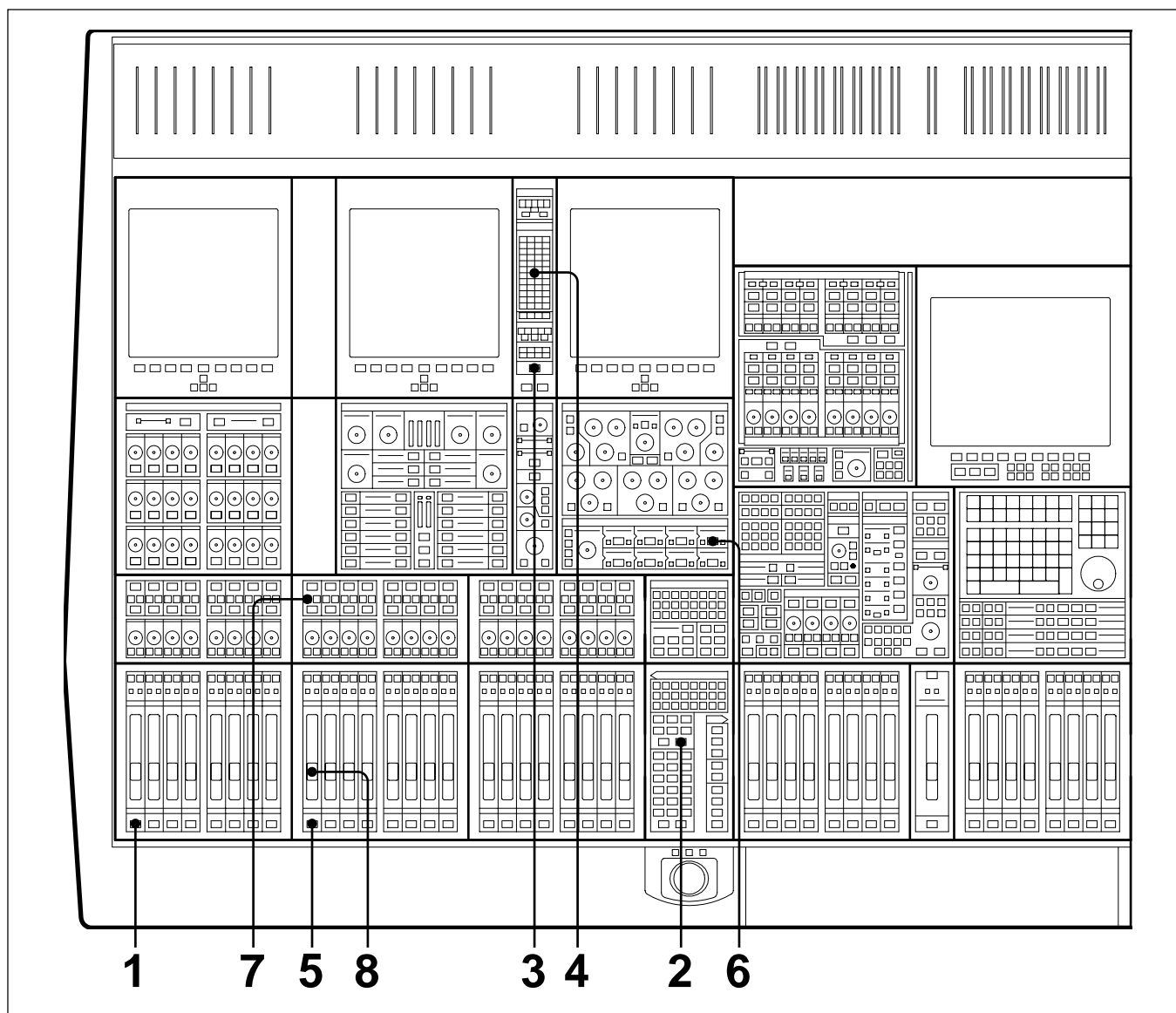

- 1 Press **ACCESS** for the desired Channel.
- 2 Make sure **CHANS** is selected on the Select To Faders panel (fire-up default).
- 3 At the Routing panel, select **CHANS**. The **L** and **R** buttons will be de-selected automatically so that the channel output is no longer routed to the Main Output Bus.
- 4 At the same panel select the destination tracks required for the bounce, in the **ROUTE TO TRACKS** section. Fader and Pan settings will be retained (L to odd-numbered tracks, R to even).
- 5 Select **ACCESS** for the first of the new tracks.
- 6 On the Input Channel & Inserts panel, select 'MULTI' and its large **IN** button in one of the eight windows. Repeat for other bounce tracks.
- 7 Select the **SEND** on the channels to which the bounce is routed, for a monitor signal for those tracks.
- 8 Set the monitor level for the new track(s).
- 9 The original balance will be bounced down to the selected multitrack tracks. Repeat steps 1 to 4 for other tracks to be bounced down.

### 3-10-11 To Set Up Super Send Groups from Multitrack

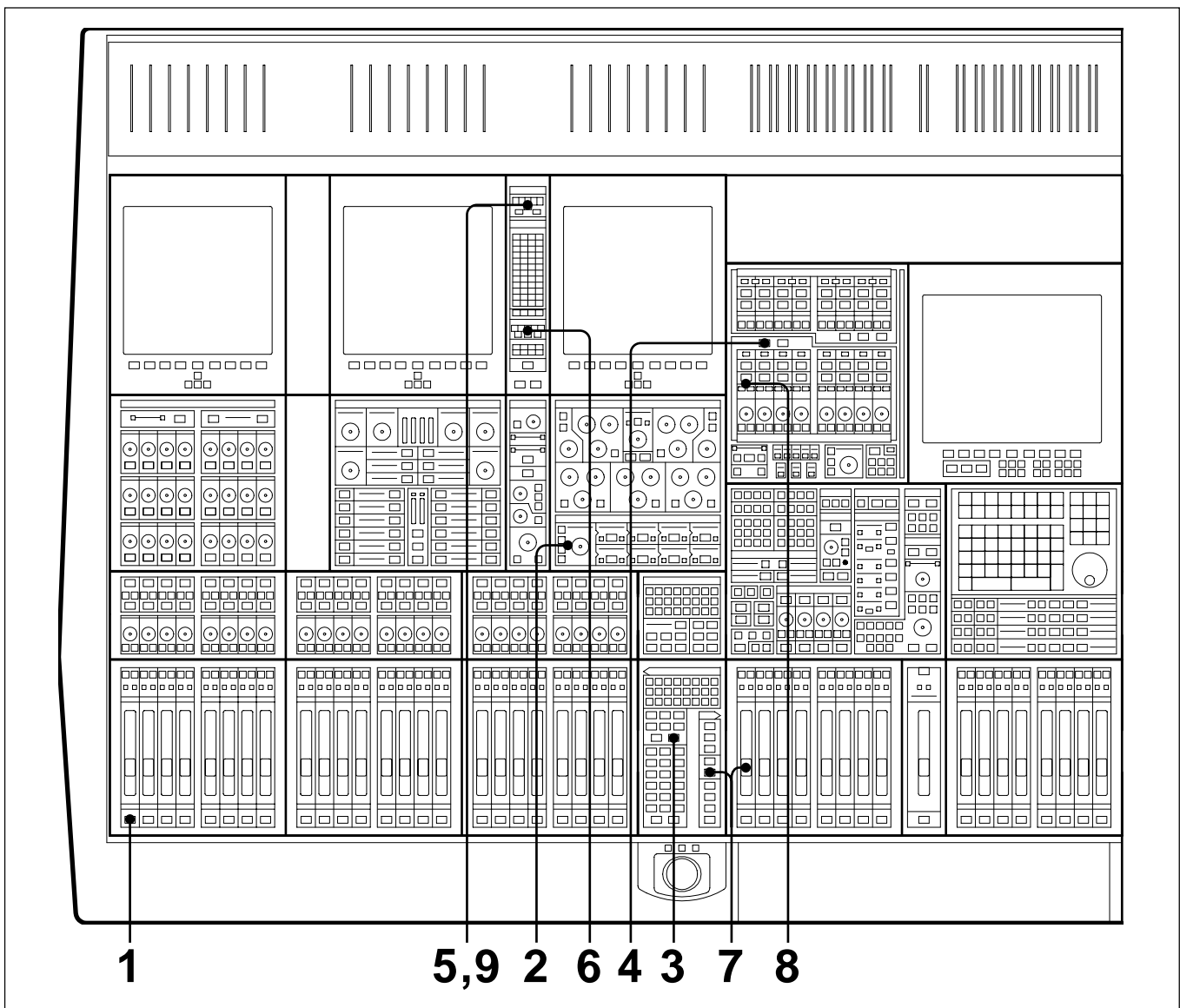

- 1** Press **ACCESS** for the first Channel to be routed to a Super Send Group (SSG).
- 2** Select **M/T** and set suitable gain.
- 3** Make sure **CHANS** is selected on the Select To Faders panel (fire-up default).
- 4** Make sure **SUPER SGs 1-8** is selected in the SSG masters section.
- 5** At the Routing panel, de-select **L** and **R**.
- 6** At the same panel, select the SSGs required, **1/9** and **2/10** in this case.
- 7** At the Select To Faders panel (SEL section), select **SUPER SGs 1-8**, then adjust the Fader to 0dB in the Central Faders panel.
- 8** Above the SSG 1 level knob select **MAIN** and its **ACCESS**.
- 9** At the top of the Routing panel select **L**.
- 10** Repeat steps 7 and 8 for SSG 2 but select **R** at the Routing panel.
- 11** Repeat steps 1 to 6 for further channels.

## 3-10 Basic Console Operations

### 3-10-12 To Set Up a De-Esser Using Dynamics Side-Chain EQ

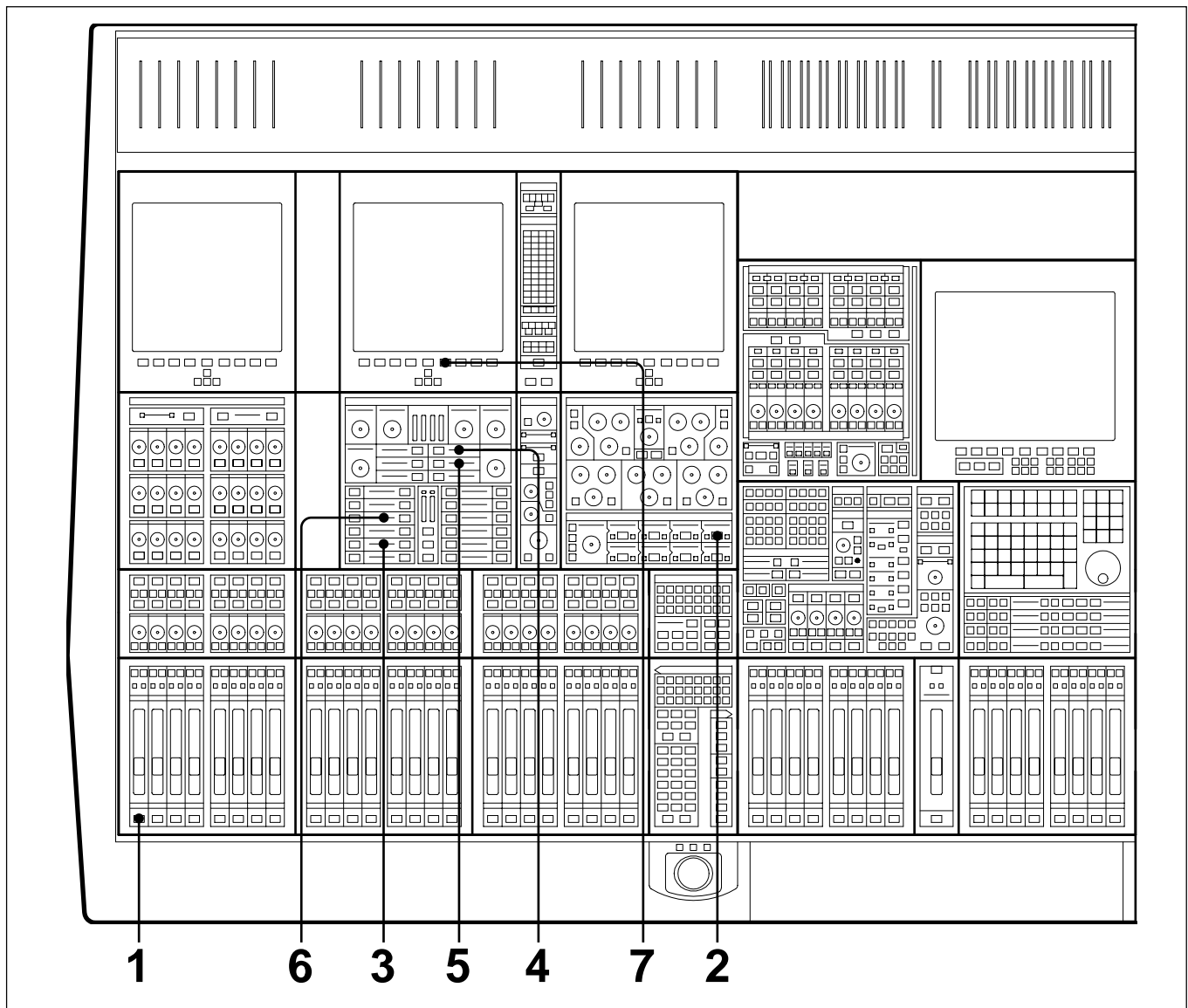

- 1 Press **ACCESS** for the desired Channel.
- 2 At the Input Channel & Inserts panel, select 'DYN' in one of the eight windows. Do this using the **+** and **-** buttons, and then press the large **IN** button.
- 3 At the Free Assign Area & Dynamics panel, select **SC EQ IN**; its **ACCESS** button will light automatically.
- 4 At the same panel, press the button adjacent to the **SIG EQ** display and adjust the HF controls to boost the frequency band to be attenuated.
- 5 Now de-select **SIG EQ** and select **S-C EQ** to affect just the side-chain signal.
- 6 At the same panel, select **COMPRESS IN**. The Compressor **ACCESS** will be selected automatically, allowing the compressor to be set.
- 7 Select the Dynamics softkey to view compressor parameters and transfer curve graph on the LCD screen.

### 3-10-13 To Link Compressor Side-Chains in a Group

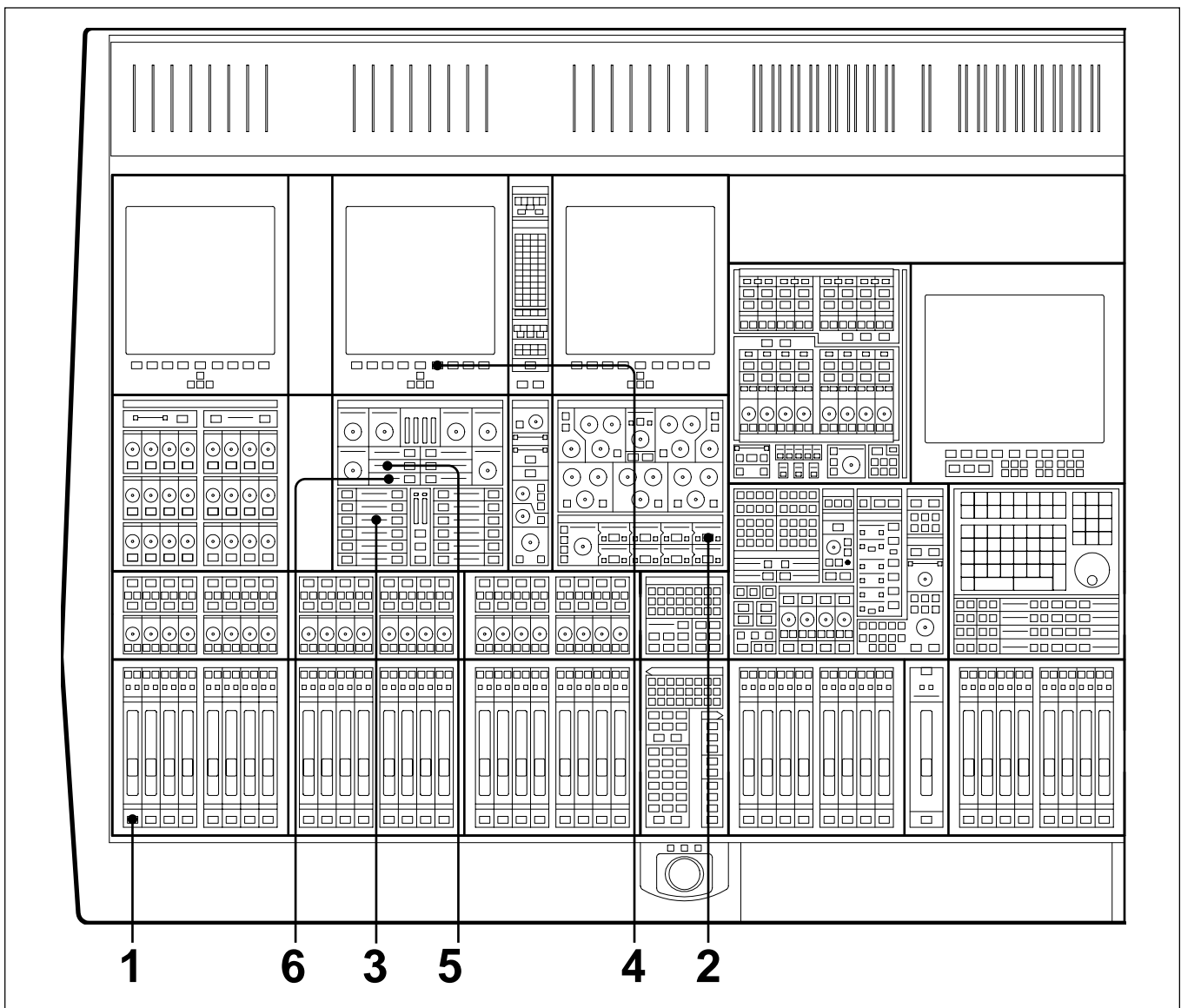

- 1** Press **ACCESS** for the first Channel to have a dynamics side-chain link.
- 2** At the Input Channel & Inserts panel, select 'DYN' in one of the eight windows. Do this using the **+** and **-** buttons, and then press the large **IN** button.
- 3** At the Free Assign Area & Dynamics section, select the **COMPRESS IN**. Its **ACCESS** will be selected automatically, assigning the Compressor controls to the panel for adjustment.
- 4** On the LCD screen above the dynamics controls, press the Dynamics softkey to view the parameters and transfer curve graph.
- 5** Select **SC TO G1** in the middle window.
- 6** Select **SC FM G1** in the lower window.
- 7** Repeat Steps 1 to 4 for further channels required in the side-chain link group.

## 3-10 Basic Console Operations

### 3-10-14 To Link Compressor Side-Chains so that One Channel Controls a Second Channel

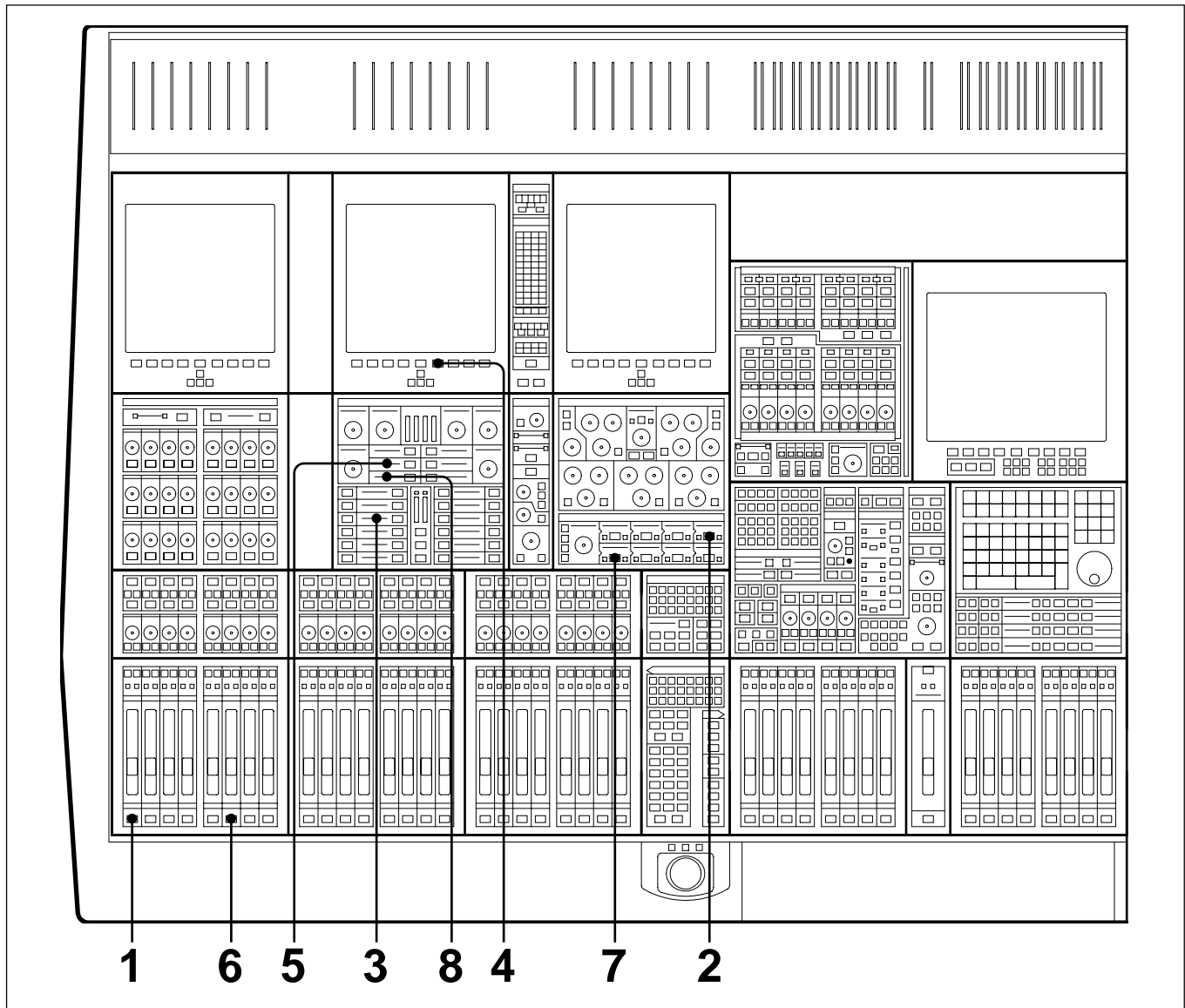

- 1 Press the **ACCESS** button for the controlling Channel.
- 2 At the Input Channel & Inserts panel, select 'DYN' in one of the eight windows. Do this using the **+** and **-** buttons, and then press the large **IN** button.
- 3 At the Free Assign Area & Dynamics section, select the **COMPRESS IN**. Its **ACCESS** will be selected automatically, assigning the Compressor controls to the panel for adjustment.
- 4 On the LCD screen above the dynamics controls, press the Dynamics softkey to view the parameters and transfer curve graph.
- 5 Select **SC TO G1** button (sends the side-chain control signal to side-chain bus 1). Make sure **LOCAL** is selected in the lower window.
- 6 Press **ACCESS** for the second channel.
- 7 At the Input Channel & Inserts panel, select 'DYN' and its **IN** button in one of the eight windows.

---

**8** At the Free Assign Area & Dynamics section, select **SC FM G1** in the lower window.

**9** All adjustments are made on the first channel.





# Chapter 4 – Signal Paths

The OXF-R3 system can be used to build a wide variety of signal paths with maximum flexibility from a basic default configuration. Creating configurations is simple. Signal paths created can be stored as Snapshots to be copied and/or recalled later.

## Chapter 4 Contents

<b>4-1</b>	<b>The Basic (Default) Signal Path .....</b>	<b>4-2</b>
<b>4-2</b>	<b>Mix-Down Signal Path with Processing Inserted .....</b>	<b>4-4</b>
<b>4-3</b>	<b>Mix-Down with Post Channel Fader Insert .....</b>	<b>4-6</b>
<b>4-4</b>	<b>Recording to a Multitrack .....</b>	<b>4-7</b>
<b>4-5</b>	<b>In-Line Channel Multitrack Recording Set-up .....</b>	<b>4-8</b>
<b>4-6</b>	<b>In-Line Channel with Insert Post Channel Fader (Monitor Function) .....</b>	<b>4-9</b>
<b>4-7</b>	<b>SEND 1 Pre Fader Headphones Feed .....</b>	<b>4-10</b>
<b>4-8</b>	<b>SEND 1 Post Fader Headphones Feed .....</b>	<b>4-11</b>
<b>4-9</b>	<b>Broadcast Mode .....</b>	<b>4-12</b>
<b>4-10</b>	<b>Channel Metering .....</b>	<b>4-15</b>
	4-10-1 Channel Meter Default .....	4-15
	4-10-2 Channel Meters to Input .....	4-15
	4-10-3 Send Monitor .....	4-16
	4-10-4 Return Monitor .....	4-16
	4-10-5 MULTI in Channel Path .....	4-17
<b>4-11</b>	<b>Dynamics Side-Chain Linking .....</b>	<b>4-18</b>
	4-11-1 Dynamics Side-Chain Link Right .....	4-18
	4-11-2 Dynamics Side-Chain Busses 1-4 .....	4-20
<b>4-12</b>	<b>Mixing to the Main Output Bus .....</b>	<b>4-22</b>
	4-12-1 Main Output Bus Set-up .....	4-24
	4-12-2 Channel Signal to the Main Output .....	4-26
<b>4-13</b>	<b>Multi-Stem Set-up .....</b>	<b>4-29</b>
	4-13-1 Multi-Stem Set-up Procedure .....	4-32
	4-13-2 Multi-Stem Monitor Path .....	4-36
	4-13-3 Multi-Stem Source Channels .....	4-40
	4-13-4 Stem Monitor Switching .....	4-48
	4-13-5 Stem Monitor Switching GUI Set-up .....	4-50
	4-13-6 Fold-Down Matrix GUIs .....	4-52

# 4-1 The Basic (Default) Signal Path

When the OXF-R3 is switched on, the system sets a default configuration as described in this section.

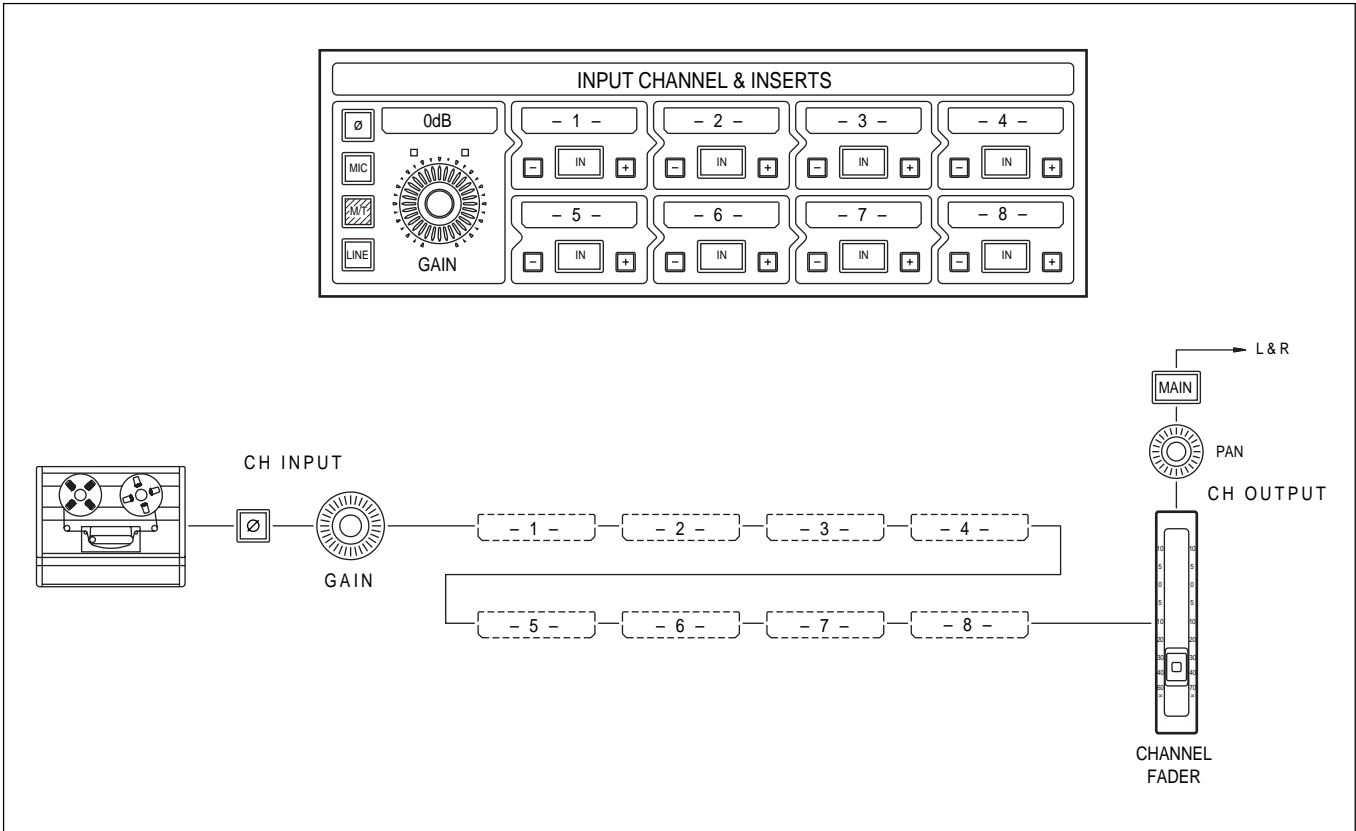

Default signal path

Signal paths are built using the controls on the Input Channel & Inserts section of the Input and Equaliser Module. Section 6-2-5 in Chapter 6 provides details of these controls.

In the default configuration shown, the M/T source button is selected and its signal feeds the multitrack phase reverse switch and gain control. The windows labelled 1 to 8 are available to insert processing elements such as EQ and dynamics but, in this default configuration, none are selected. From the phase reverse switch and input gain stage, the signal is passed directly on to the channel fader, through the channel pan and on to the MAIN L/R output bus.

**Note:**

*The MIC, LINE and M/T inputs each have their own individual phase switches and gain control stages.*

Moving on from the very simple (default) channel signal path, a selection of processing elements is available that can be inserted in any order. This is achieved using the eight small window sections, each with + and - buttons either side and an IN button. All available processing blocks in the Assignable Panel Area can be accessed in any of the windows by toggling the + and - buttons.

Functions currently supported are:

- **EQ**            5 BAND PARAMETRIC EQ with SHELVING HF & LF (shelving is switchable)
- **FILT**        HIGH & LOW PASS FILTERS (6dB-36dB / octave in 6dB steps)
- **DYN**        GATE, EXPANDER, COMPRESSOR & LIMITER
- **INSERT**    EXTERNAL DEVICE INSERTION POINT
- **DELAY**     DIGITAL DELAY (up to 1.2s with Regen.)
- **MULTI**     INSERTION of MULTITRACK SEND, ROUTING & MONITOR PATHS
- **FADER**     CHANNEL FADER

The small arrow shape in the window outline points in the direction of the signal flow. Once the required function has been selected, press the IN button, which inserts that function into the signal path. It also becomes the master in/out switch for its function and can be automated.

The order of this signal path is defined according to the processes selected in each window. At any time, the order can be changed by de-selecting the IN button and toggling the name in the window to an alternative one. To clear a window, place the default box number back in the display, by pressing the + and - buttons simultaneously. Selection changes can only be made if IN buttons are not selected. If the same function is selected in two different windows at the same time, one of them will have an asterisk either side of the function name to inform the user that the process has already been selected in another window. Each function block can be used once per channel only. The following diagram shows an example of a signal flow through a channel configured for mix-down.

## 4-2 Mix-down Signal Path With Processing Inserted

For each channel, select **MIC**, **M/T**, or **LINE** as the mix-down source, depending on the situation. All input types may be cross-patched as desired via the LCD screens above the Channels areas. (Refer to Chapter 5, Control Screens for details).

As described previously, the Input Channel & Inserts section allows the setting up of processing functions in any order. The example configuration shown is a good starting point in a mix-down situation.

**Note:**

'MULTI' should not be selected in any window for multitrack mix-down. 'MULTI' is used in the channel path to create an in-line channel, described later in this chapter.

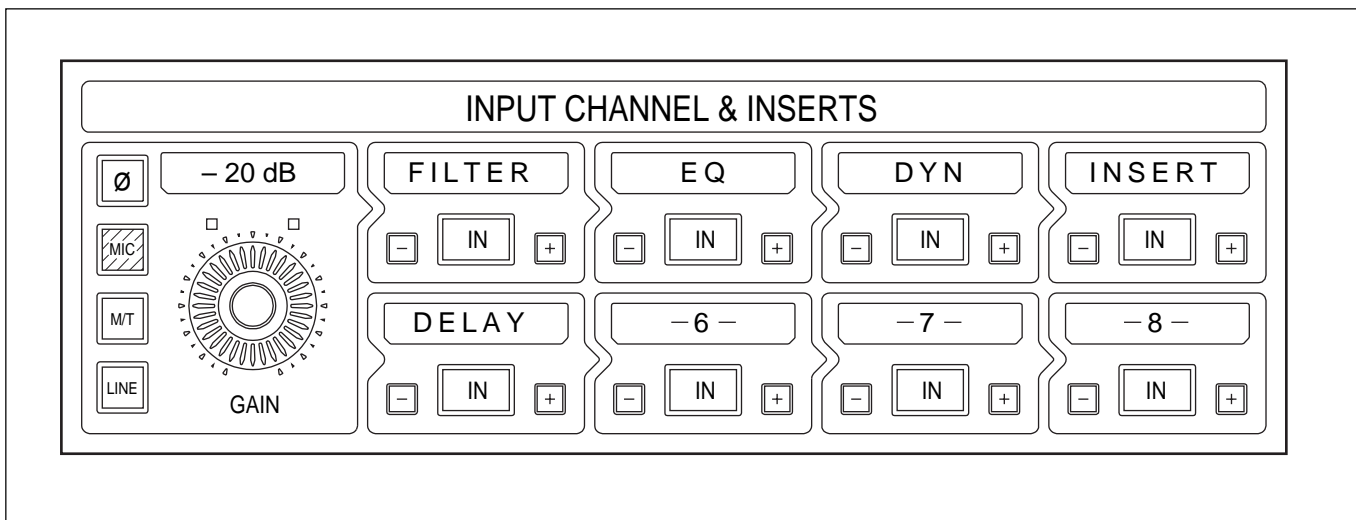

Mix-down channel path - example configuration

The fire-up default sets all channel outputs routed to the Main Output Bus via the **MAIN** button on the Routing panel. To feed the Main bus directly, make sure **MAIN** is selected on. Alternatively, channel outputs can be routed to Super Send Groups (SSGs) to group a selection of channels together.

To accomplish this, de-select **MAIN** and select an SSG at the Routing Panel. The output of the SSG can itself be routed directly to the Main Output Bus by selecting its **MAIN** button in the Multi-Format & Super Send Groups section, in the centre section.

Each SSG has its own knob for level control. Alternatively, on the Select To Faders panel in the SEL section, select SSGs 1-8 to set faders in the centre section to control SSG levels. The fire-up gain setting for SSGs is unity.

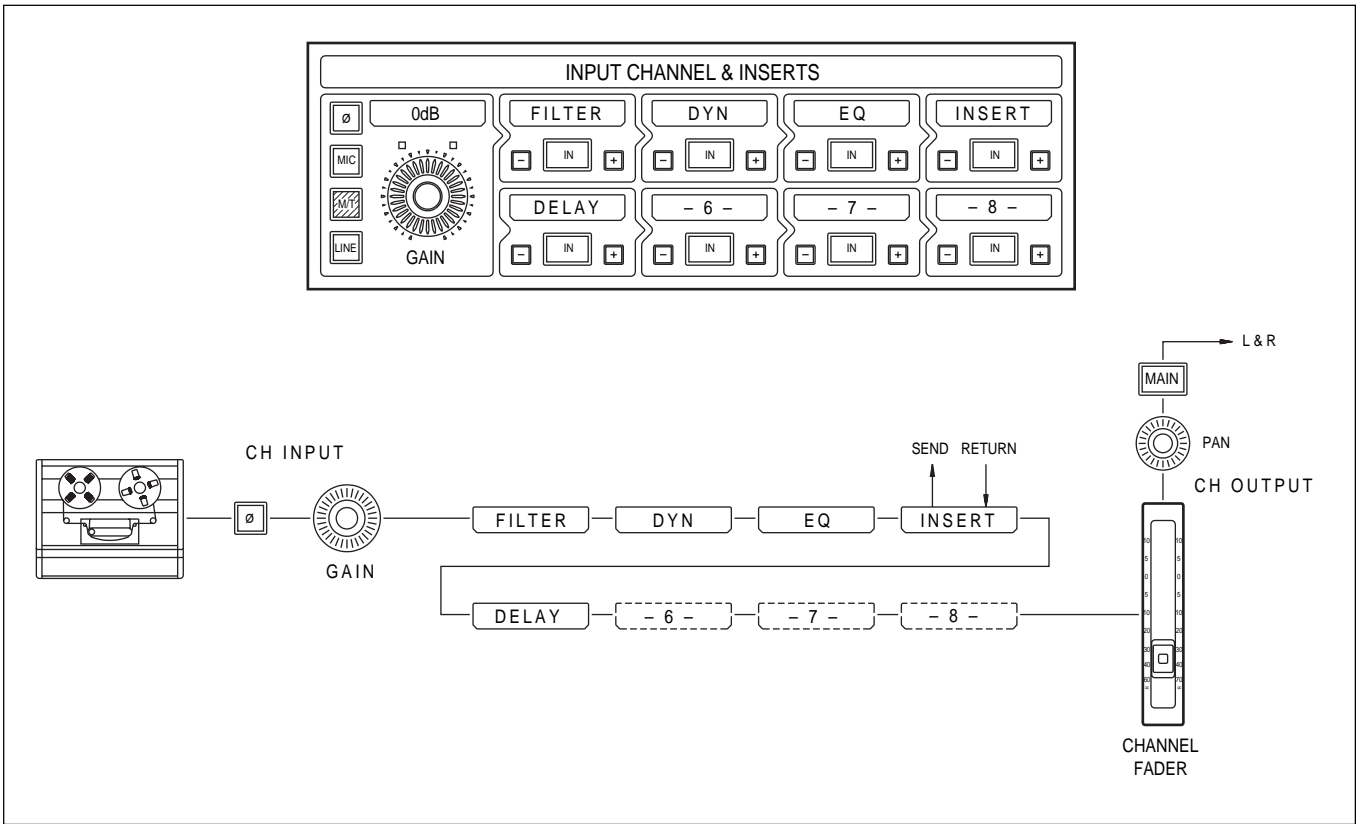

Signal flow for mix-down with processing in the channel path

## 4-3 Mix-down with Post Channel Fader Insert

The ability to swap functions easily enables the user to start with identical signal paths set up across the console using copy or snapshot functions. Then channels may be changed on an individual basis, according to the situation.

By selecting FADER in one of the eight windows, functions can be placed after the channel fader. The diagram shown is the same configuration as the previous mix-down set-up, but with the INSERT point placed after the fader, thus a post fader insert.

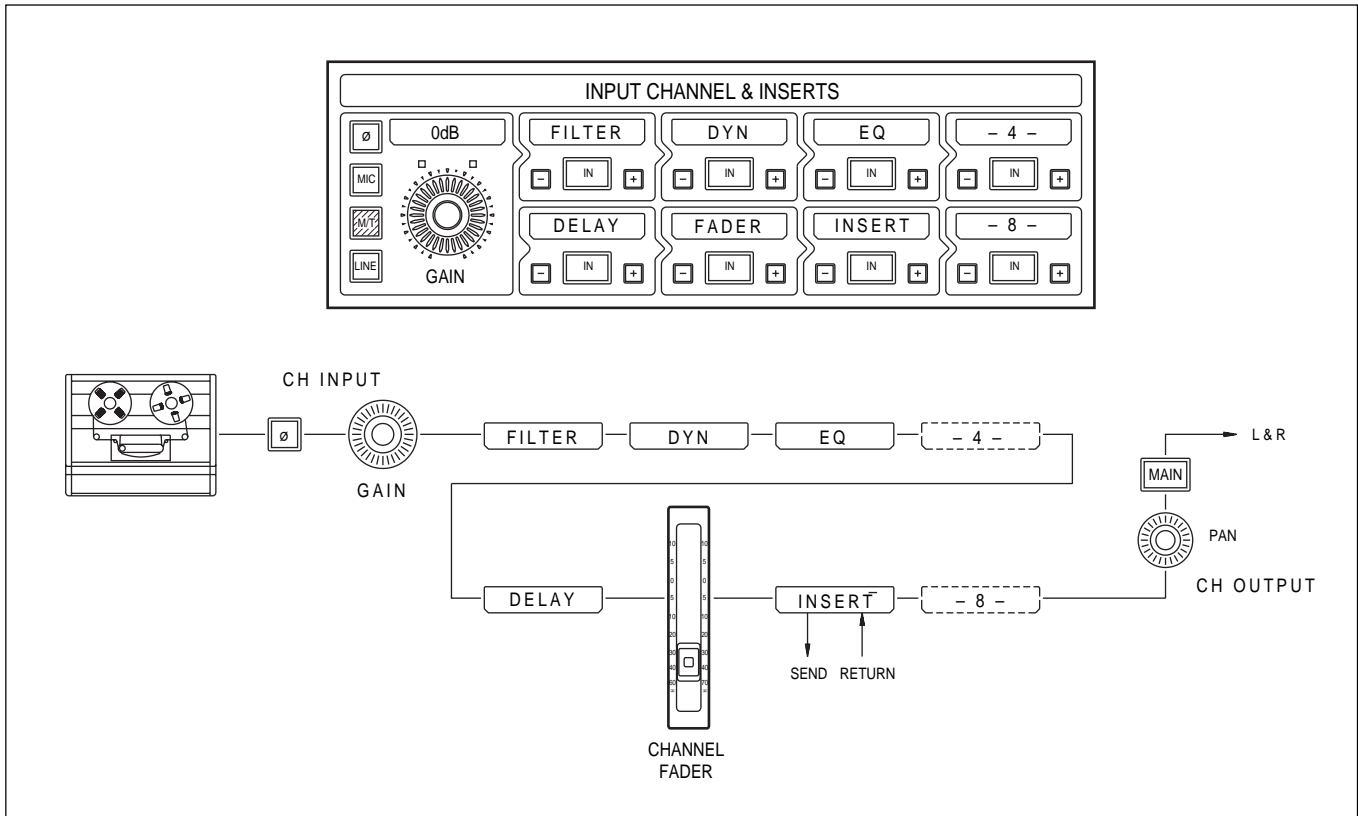

Mix-down with post channel fader insert

## 4-4 Recording to a Multitrack

To include the multitrack in the channel path, select MULTI in one of the eight windows in the Input Channel & Inserts section. This creates an in-line channel configuration, separating the channel input and monitor paths.

**HINT:** As a starting point, position the multitrack (MULTI) in window number 5. This allows windows 1 to 4 to be used for other functions such as EQ and dynamics so that they affect the recorded signal. Windows 6 to 8 are still available for inserting functions into the monitor path post multitrack. In other words, the top row of processing blocks forms the channel path, whilst the lower row is the monitor path.

Once one channel is set up, it can be copied to other channels across the console as required (*described in Chapter 7, Session Management™*).

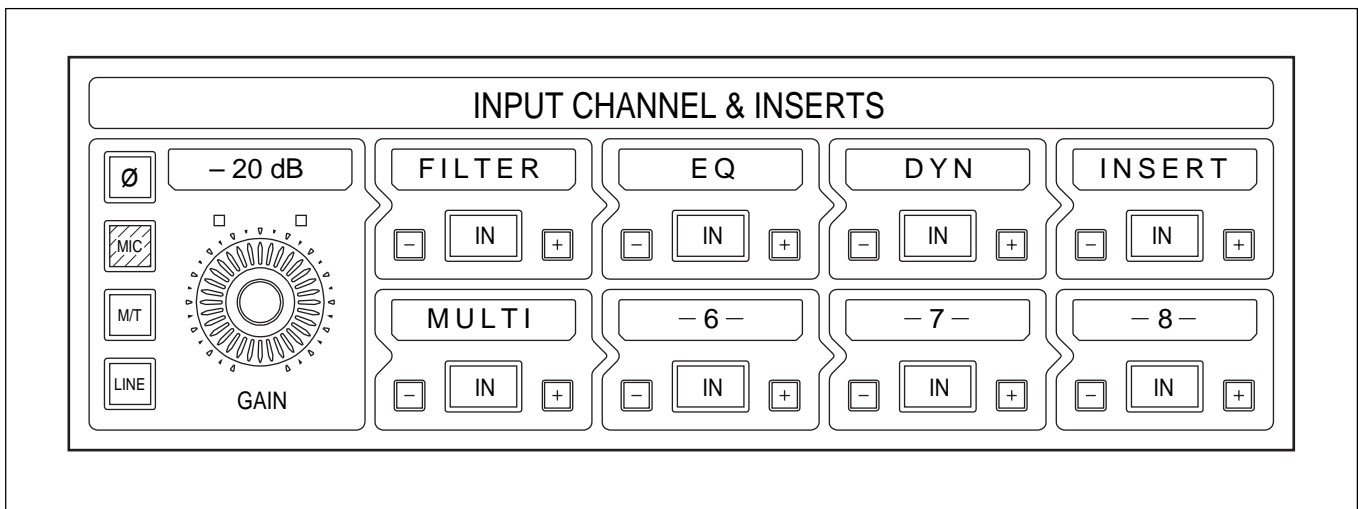

In-line channel multitrack recording configuration

All console inputs are available on the Channel Input Screens for cross patching. They are split into three different screen pages: MIC, LINE and M/T inputs.

(Refer to Chapter 5, Control Screens, for further details)

# 4-5 In-Line Channel Multitrack Recording Set-up

If FADER is not placed in any of the eight windows, it is automatically positioned after window number -8- equivalent to the monitor fader in an in-line console.

By selecting MULTI to one of the eight windows, the multitrack machine is inserted into the path and creates an In-Line channel. This then assigns the **SEND** and **RET** (urn) buttons, situated above the pans, to control whether the user is listening to the signal being sent to the tape or the return signal from the tape. The signal from tape is now sent to the monitor path via the channel fader. The **RECORD** button arms the tape machine into ready record for that track. The signal from the Mic input is sent to the routing via the send level on the Multitrack panel. This level can also be controlled by the fader by selecting M/T SEND. (See *SELECT TO FADERS* functionality in Chapter 6, *Technical Descriptions*).

Any function in the eight windows positioned before the word MULTI affects the signal recorded on tape. This is equivalent to the channel path of an in-line analogue console. The functions positioned after MULTI affect the monitor signal. For example, the diagram shows the word MULTI in window position 5. The effects of FILTER, EQ and INSERT are all being recorded. The DYNAMICS affect just the monitor signal.

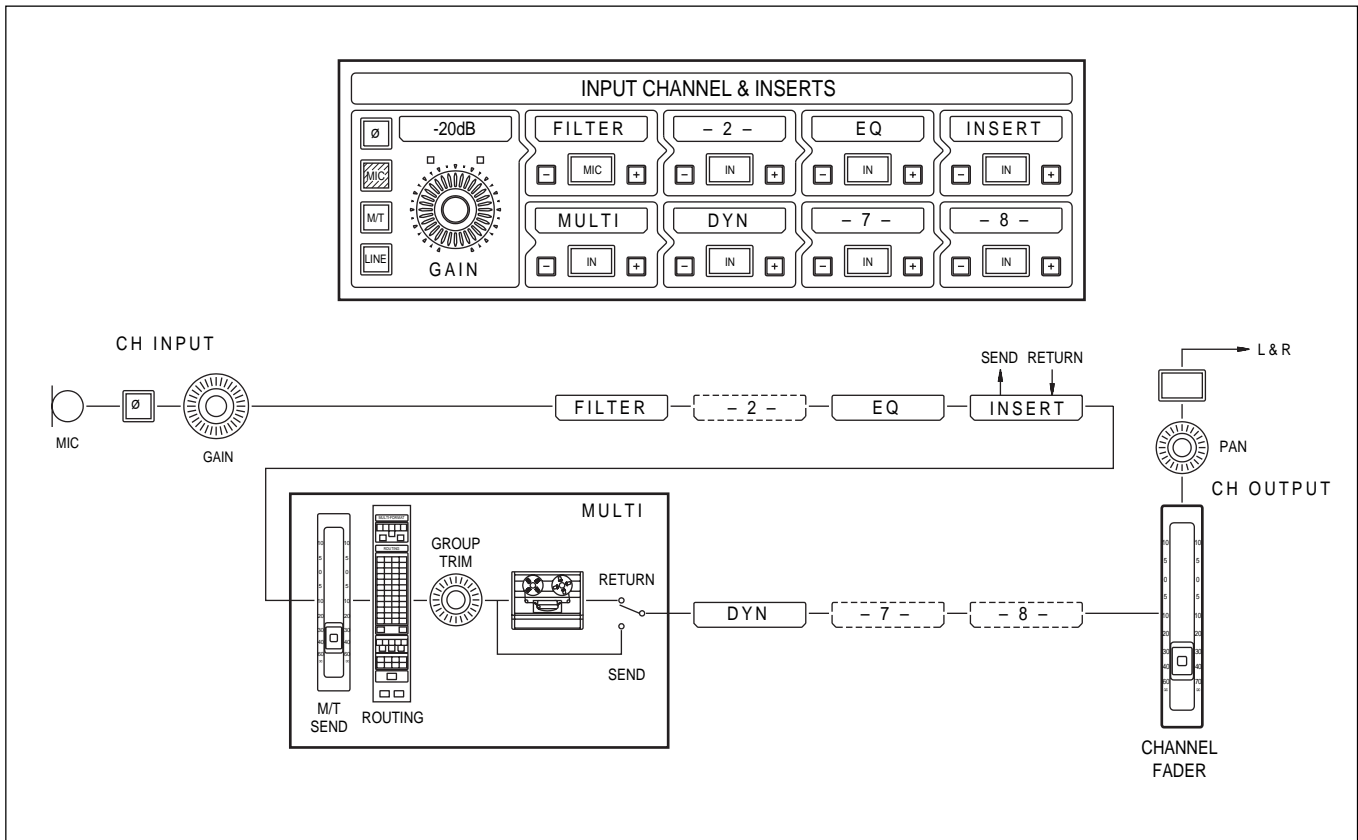

In-line channel for recording to a multitrack



# 4-6 In-Line Channel with Insert Post Channel Fader (Monitor Function)

As with the Mix-down examples shown previously, post fade functions can be configured in the same way during recording. The diagram shows the channel fader, which is controlling the monitor mix, with a post fade insert point.

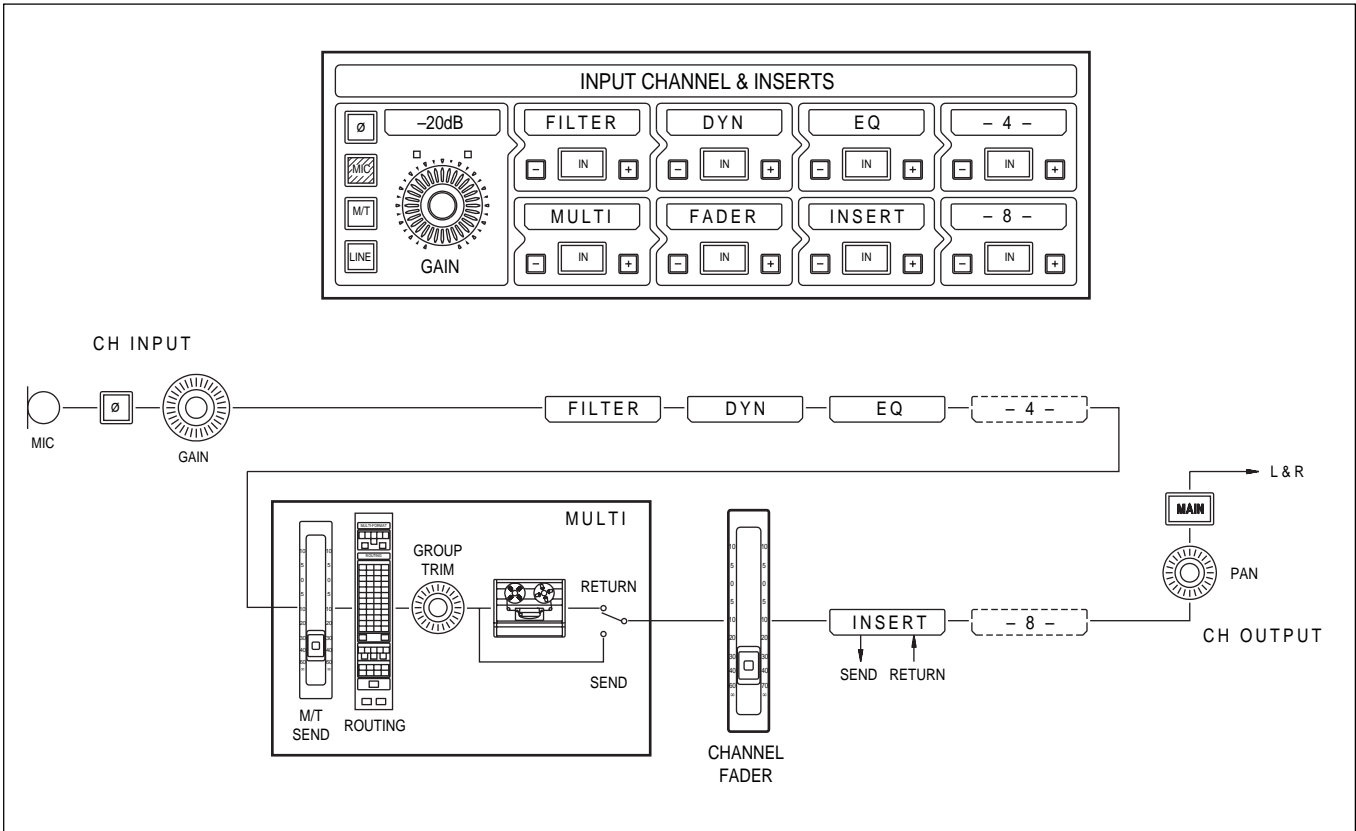

In-line multitrack with post fader insert in the monitor path

## 4-7 SEND 1 Pre Fader Headphones Feed

The diagram shows a typical Pre Fader headphone mix set-up, where a channel is configured in multitrack mode. SEND 1 is used to send a signal to headphones from the tape return signal. As the signal path indicates in the diagram, the headphones are positioned after the dynamics function sourced from the monitor path, pre fader.

To achieve this, on the upper section of the SENDS 1-24 panel, first make sure that SEND 1 is selected in the 'SELECT SOURCE FOR' display (upper right in the SENDS 1-24 panel). If not, use the large **+** and **-** buttons to select SEND 1. Then, in the left hand display window of the same panel, use the small **+** and **-** buttons to display - 8 - which will cause the **SELECT** button to light. Press the **SELECT** button and its light goes out to confirm the new source point. The source for SEND 1 bus is now fed from the output side of the channel path window displaying - 8 -.

This procedure may be used for each SEND bus, allowing the source point to be from any junction within the channel signal path, not just pre and post fader, as with the majority of analogue consoles.

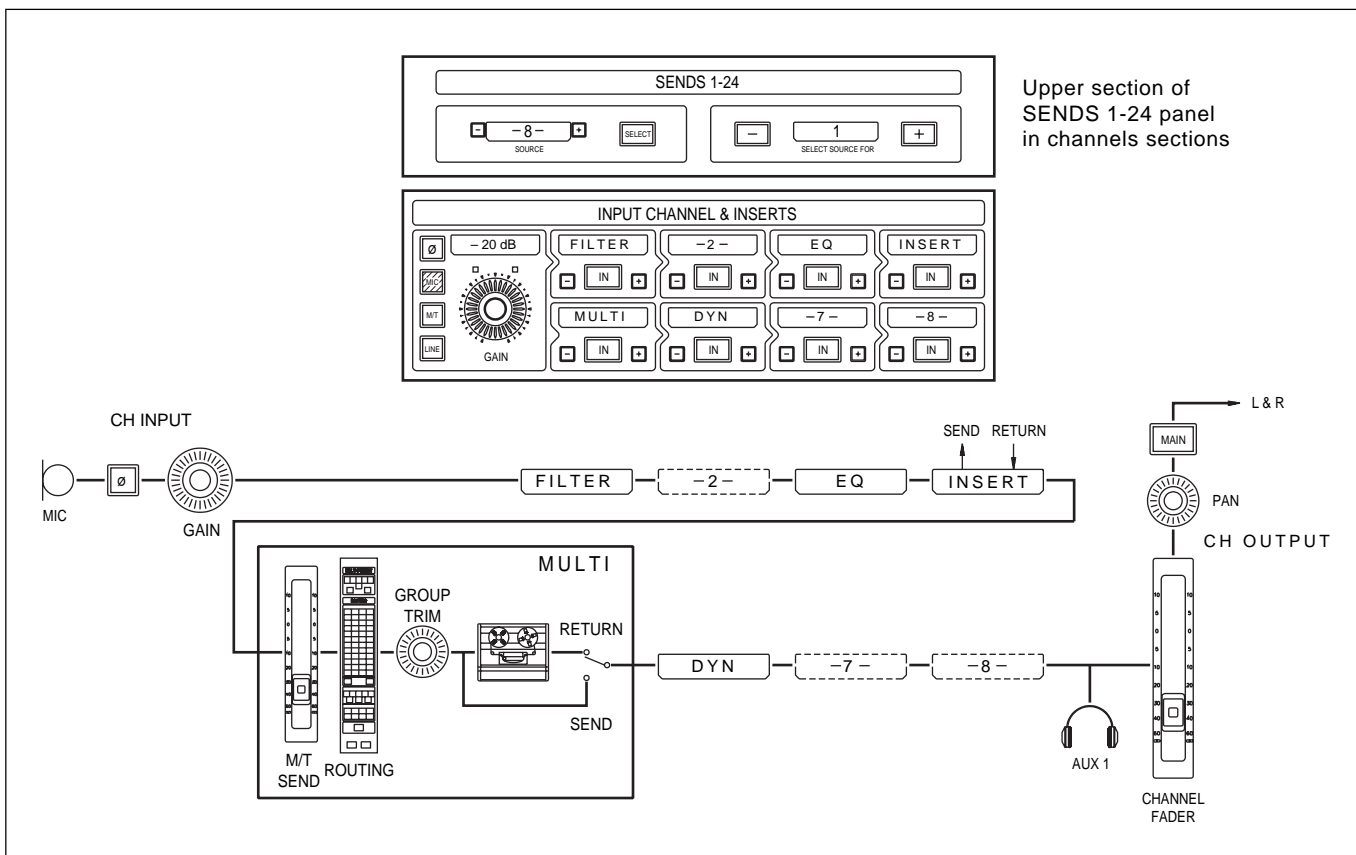

SEND 1 pre fader headphones feed

### Global select Source for all channels

First select the **ACCESS** button on the Main fader. Then select the appropriate source point in the **SOURCE** display in the upper right section of the SENDS 1-24 panel using the **+** and **-** buttons. Then press the **SELECT** button in the same section to set that source for all channels.

# 4-8 SEND 1 Post Fader Headphones Feed

To change the Pre Fader configuration to a Post Fader set-up, in the upper left SOURCE window of the SENDS 1-24 panel, simply toggle the SOURCE window to CH OUTPUT which will cause the **SELECT** button to light. Press **SELECT** and its light goes out confirming the new source point.

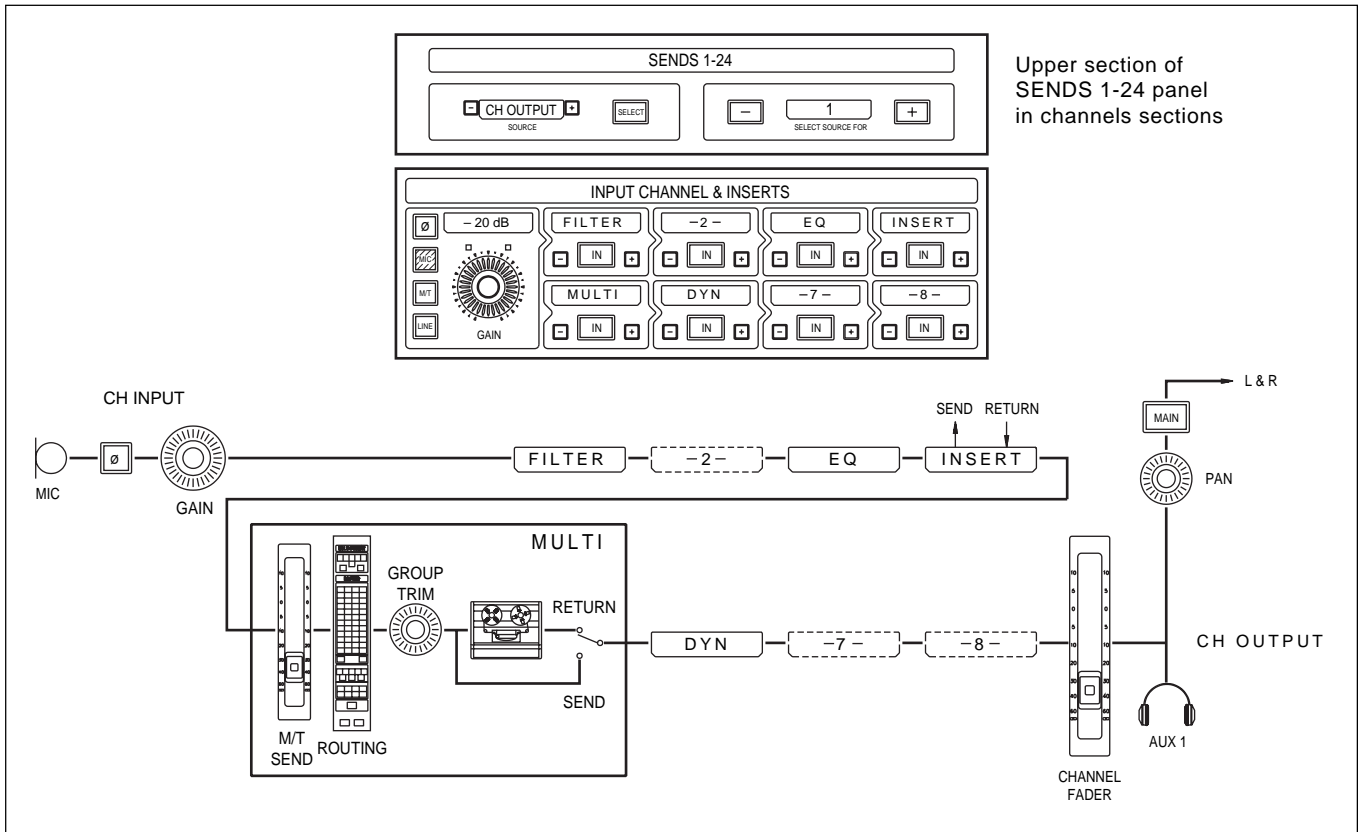

## General

In 'Broadcast Mode' the operator is able simultaneously to:

- a) **Mix individual inputs to the Main Output Bus**  
and
- b) **Record a multitrack backup as a parallel operation.**

The multitrack output can be monitored separately via a stereo bus accessed by the External Source Selector in the Monitor panel in the centre section of the console.

## Setting up

At the Input Channel & Inserts panel, set the channel path as for Mix-down. Although a signal will be recorded to the multitrack, MULTI should not be selected in any of the 8 channel path windows. Select **MIC** or **LINE** and make sure **MAIN** is selected, at the Routing panel, for each channel required to feed the Main Output bus. Cross patch input sources via the LCD screens above the Channels sections.

*(Refer to Chapter 5, Control Screens for further details).*

To send the signal for each channel to the Multitrack as well as to the Mix bus:

1. Press the **ACCESS** button on the first channel to be routed. Route to the track required using the Routing panel.
2. On the Multitrack panel, toggle the **+** and **-** buttons either side of the window labelled SOURCE, below the Group Trim knob, until the desired source point is displayed. This can be taken from any of the 10 junctions within the signal path displayed on the Input Channel & Inserts panel. The source point for the multitrack feed will be taken from directly after the process displayed in the SOURCE window.

In the first diagram, CH INPUT is shown in the SOURCE window, enabling a 'clean' line level signal to be sent from a point immediately following the input stage.

In the second diagram, CH OUTPUT is shown in the SOURCE window, enabling a signal to be sent which includes the effects of all selected processing and adjustments made on the channel fader.

## Further Examples

With EQ selected in the SOURCE window, the feed to the multitrack would be affected by the high and low pass filters (FILTER), dynamics section (DYN) and the equaliser section (EQ), but not by the INSERT processing. If FILTER was the source, then just filters would affect the signal and so on. All processes affect the mix feeding the Main Output bus.

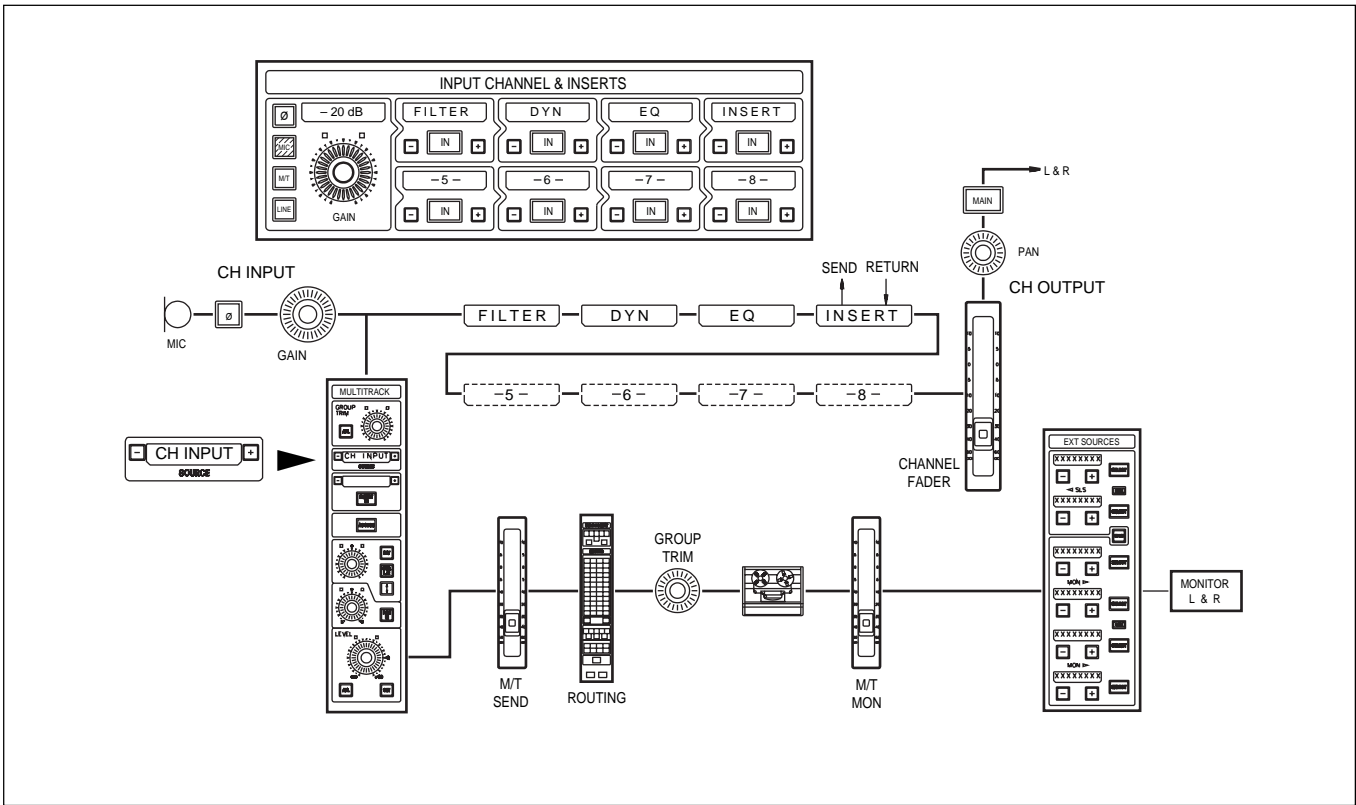

Broadcast Mode – Channel Input source

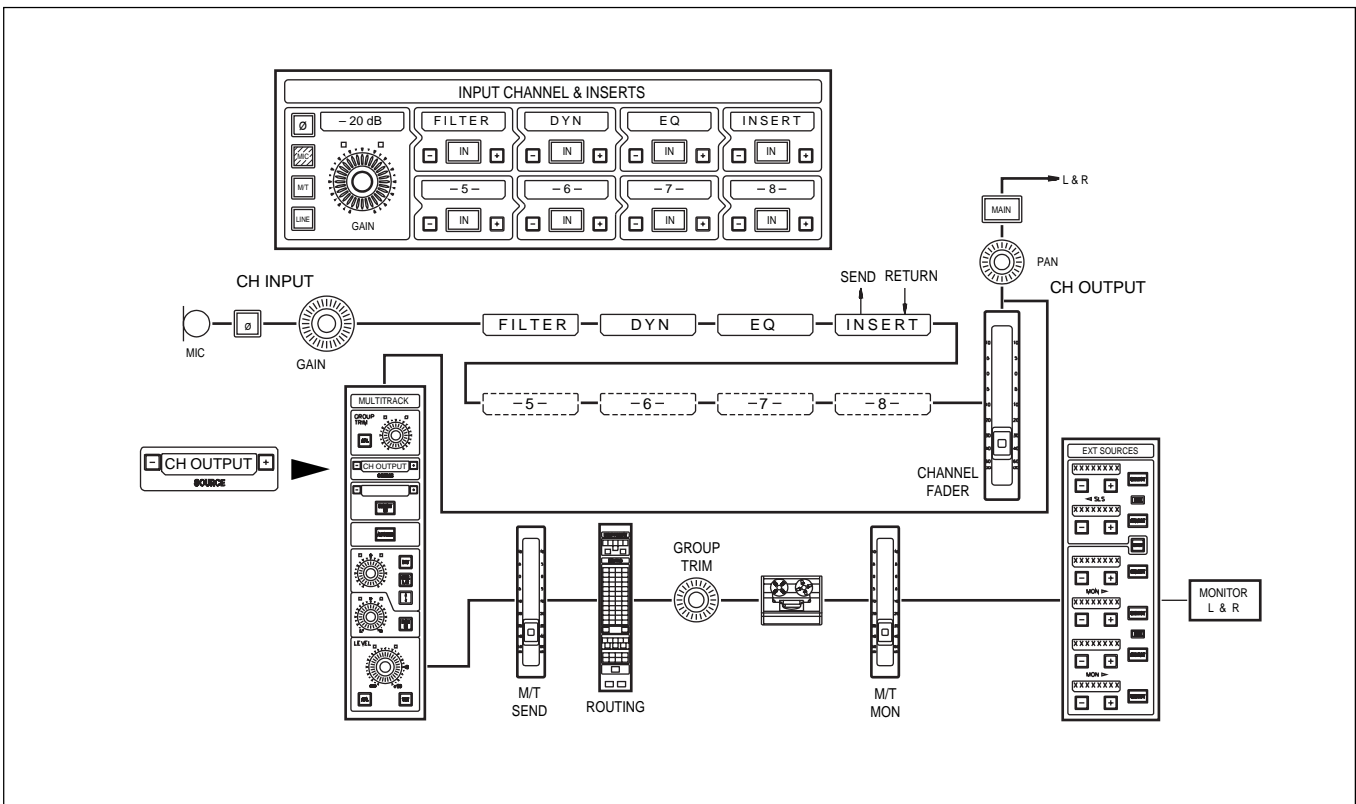

Broadcast Mode – Channel Output source

### Monitoring the multitrack

To listen to the stereo Multitrack Send Monitor Bus, select M/T MON at the Ext. Source section of the Monitor panel in the centre section. This is a dedicated internal monitor bus designed specifically for use when making a parallel multitrack recording, alongside a stereo mix.

To set up a monitor balance, select **M/T MON** at the Select To Faders panel and use the channels section faders.

The default monitor source is the Main Output bus. Selecting M/T MON at the Ext. Source section allows direct comparison of the Multitrack Monitor mix and the Main Output bus mix.

**Note:**

*The **SEND** and **RET** (urn) Ready/Monitor switching on the control surface functions in the normal manner in Broadcast Mode.*

# 4-10 Channel Metering

The Channel Meter sources are set automatically according to the functions in use in the channels.

## 4-10-1 Channel Meter Default

The fire-up default for the Channel Meters is pre fader as illustrated in the following diagram. This is denoted on the OXF-R3 by the red 'C' legend at the top of the Channel Meters.

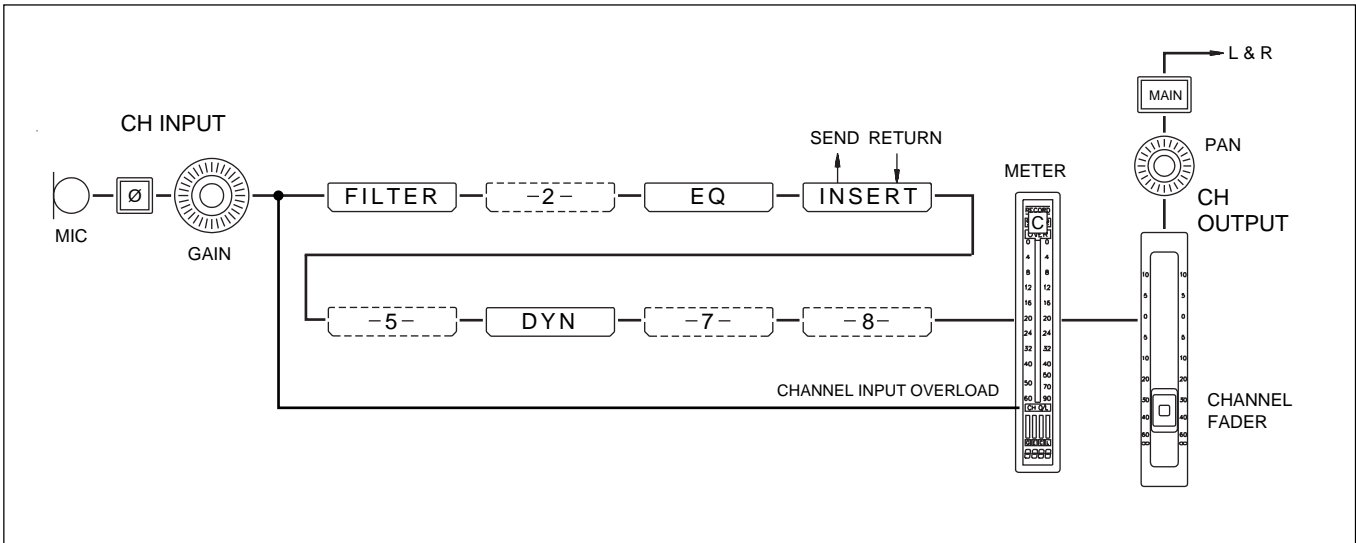

Channel metering – Default

## 4-10-2 Channel Meters to Input

Selecting **MTRs TO INPUT**, at the METERS selector in the centre section monitor panel causes the channel meters to monitor the audio level in the digital domain, post the channel input gain control stage.

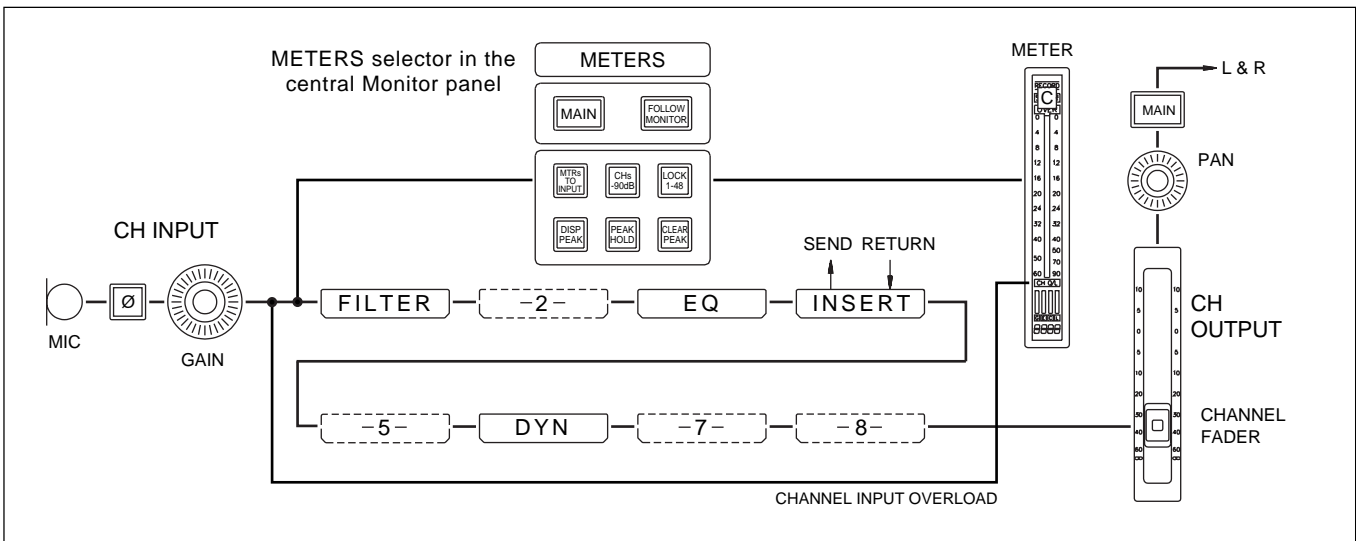

Channel metering – Channel Meters to Input

## 4-10 Channel Metering

### 4-10-3 Send Monitor

Selecting the **SEND** button at the channel record remotes causes the Meter to take its source from signal being sent to tape, indicated by the yellow 'S' legend at the top of the Channel Meters.

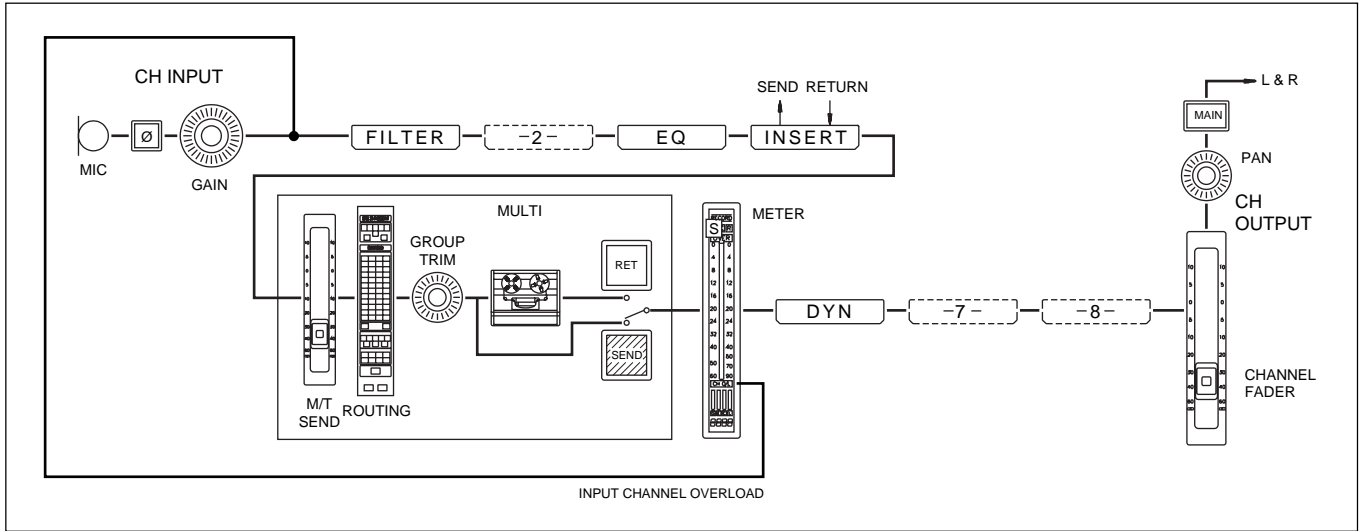

Channel metering – Send Monitor

### 4-10-4 Return Monitor

Selecting the **RET** button at the record remotes selects the tape return as the source, indicated by the green 'R' legend at the top of the Channel Meters. In Record, the meter is automatically switched to monitor SEND.

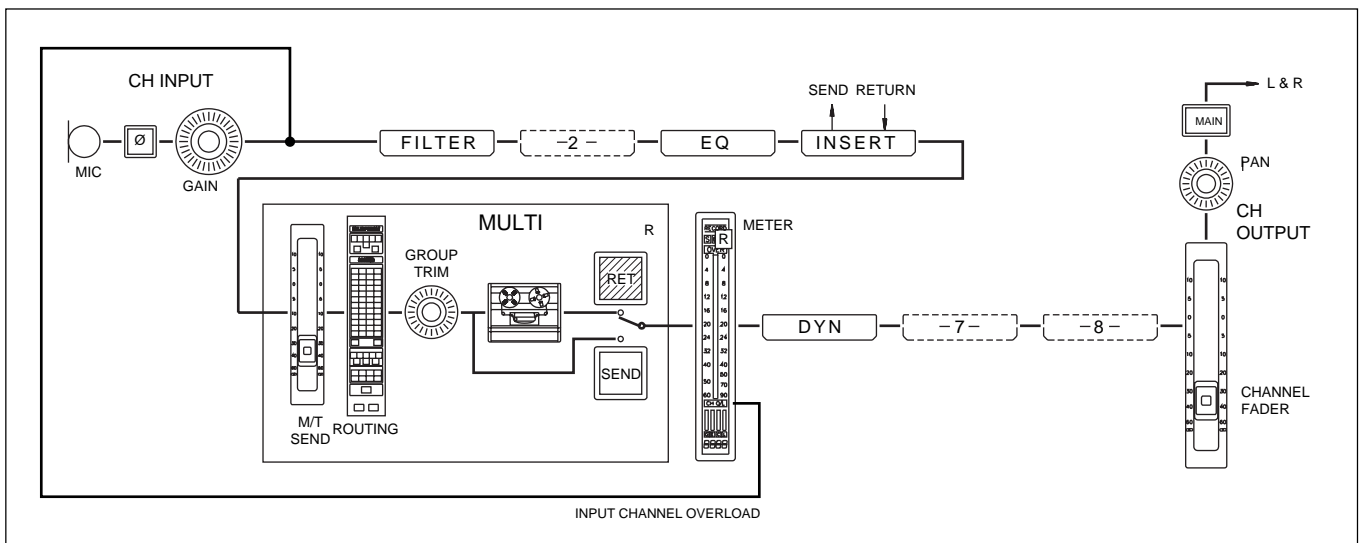

Channel metering – Return Monitor

**Note:**

If both **SEND** and **RET** are selected, the **SEND** monitor signal takes priority.



## 4-10-5 MULTI in Channel Path

If MULTI is selected in one of the 8 windows but neither **SEND** nor **RET** push-button is selected, the Meter is fed pre fader. The input signal source is overridden by the multitrack return signal.

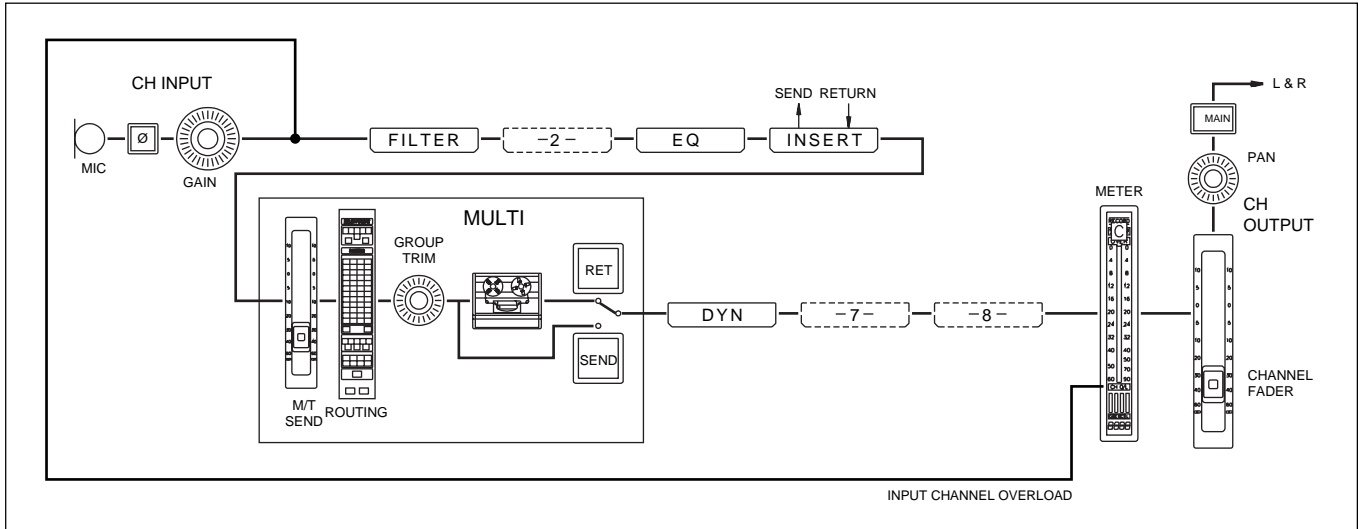

Channel metering – MULTI in channel path, but Send or Return push-buttons are not selected

# 4-11 Dynamics Side-Chain Linking

## 4-11-1 Dynamics Side-Chain Link Right

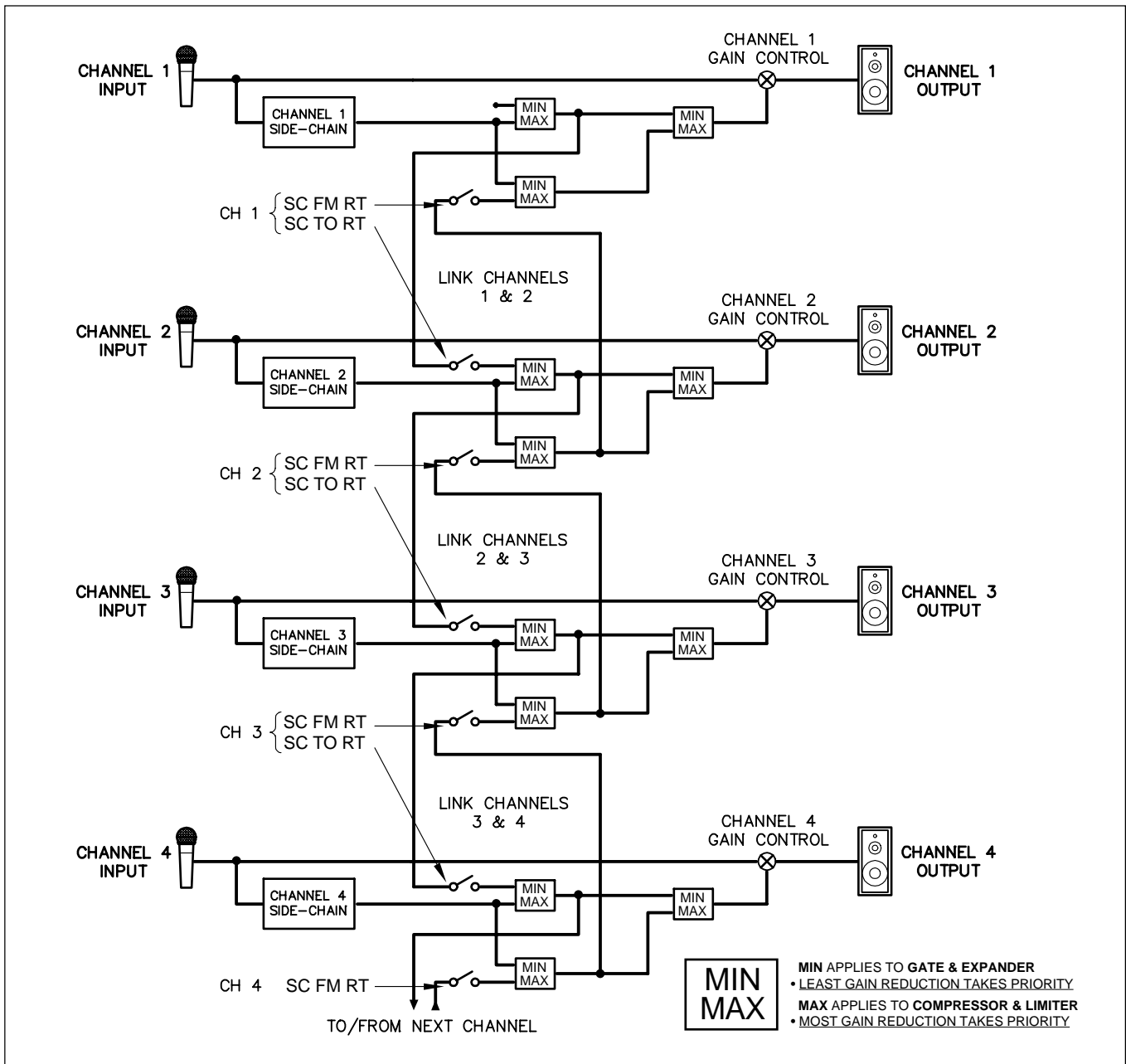

Block schematic to illustrate Dynamics Side-Chain Linking to the next channel to the right

### Dynamics Side-Chain Link Right in general

This function allows the Dynamics section in the next channel to the right to be controlled by the Side-Chain of the currently accessed channel and vice versa. The linking can be cascaded over any number of channels to form a group, and may be linked through channels where the Dynamics sections are not active. No matter how many channels are cascaded, the one with the largest Side-Chain Control Signal will accurately control all the rest. It is often useful to Copy or Link the front panel controls of the channels using the Dynamics Side-Chain Link Right function (see 7-6-8 in Chapter 7)

### Dynamics Side-Chain Link Right set-up procedure

The buttons for this operation are located in the Free Assign Area & Dynamics panel. They are the assignable buttons just left of centre in the upper section of this panel. Their function is indicated by individual 8 character displays, one positioned to the left of each button (see Chapter 6, section 6-2-6).

There are two 8 character displays which relate to this function, and the fire-up default is **LOCAL** in both. The upper display indicates the destination for the Side-Chain Signal generated by the current channel. The lower display indicates the source for the Side-Chain Signal for the current channel.

### Set-up procedure

- 1** The middle button sets where the Side-Chain Control Signal is sent. The default is **LOCAL** i.e. to its own channel. Step through the options with this button and set it at **SC TO RT**. This setting sends its Side-Chain Control Signal to the next channel to the right.
- 2** The lower button sets where the Side-Chain Control Signal is taken from. The default is **LOCAL** i.e. from its own channel. Step through the options with this button and set it at **SC FM RT**. With this setting, the current channel takes its Side-Chain Control Signal from the next channel to the right.

A set-up using 1 and 2 above creates a stereo dynamics section.

- 3** Repeat 1 and 2 above on further channels as desired.

#### Note

*For correct operation, elements such as GATE, COMPRESSOR etc, must be switched in on each channel involved in this type of group.*

## 4-11 Dynamics Side-Chain Linking

### 4-11-2 Dynamics Side-Chain Busses 1-4

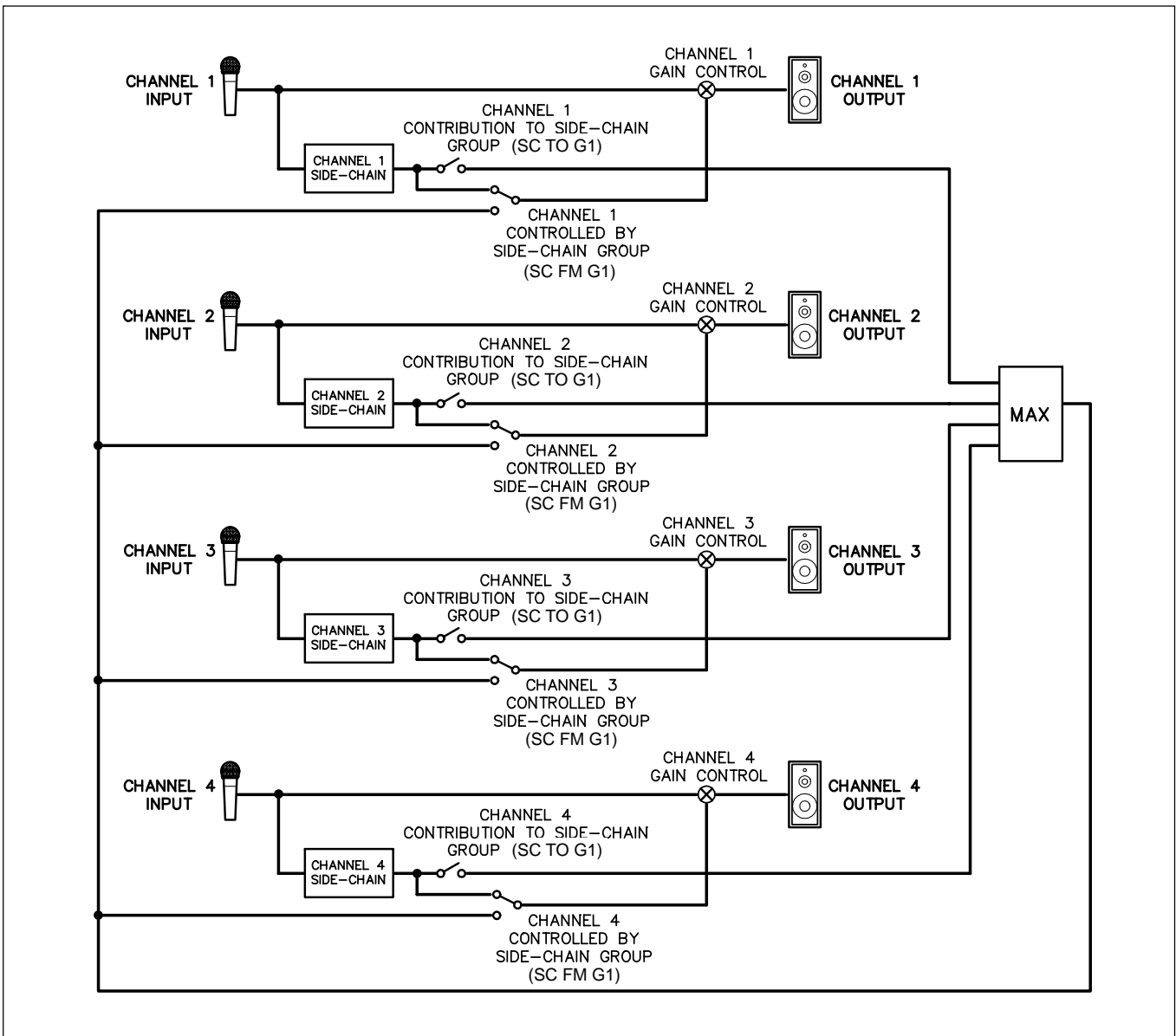

Block schematic to illustrate the switching for Dynamics Side-Chain Bus 1

#### Dynamics Side-Chain Busses 1-4 in general

This function allows any channel to feed its Side-Chain Control Signal to any one of four Side-Chain Busses. Any channel can also take its Side-Chain Control Signal from any one of the four Side-Chain Busses. There is no limit to the number of channels accessing the Side-Chain Busses. For a given set of channels linked to an individual Side-Chain Bus, the channel generating the largest Control Signal will accurately control the rest of the channels

### Dynamics Side-Chain Bus operation

The buttons for this operation are located in the Free Assign Area & Dynamics panel. They are the assignable buttons just left of centre in the upper section of this panel. Their function is indicated by individual 8 character displays, one positioned to the left of each button (see Chapter 6, section 6-2-6).

There are two 8 character displays which relate to this function, and the fire-up default is **LOCAL** in both. The upper display indicates the destination for the Side-Chain Signal generated by the current channel. The lower display indicates the source for the Side-Chain Signal for the current channel.

For example, a display indicating **SC TO G1** means that the Side-Chain Signal is being fed to Side-Chain Bus 1. **SC TO G2** means that the Side-Chain Signal is being fed to Side-Chain Bus 2. **SC FM G4** means that the Side-Chain Signal is being received from Side-Chain Bus 4.

### Dynamics Side-Chain Bus set-up procedure

The following example will send the Side-Chain Signal to Compressor Side-Chain Bus 1. It will also use Bus 1 as its Side-Chain Signal source. This allows:

- control of itself
- control of any other channels using Side-Chain Bus 1 as their Side-Chain source
- control by any other channels sending their Side-Chain Signal to Side-Chain Bus 1.

- 1** The middle button sets where the Side-Chain Control Signal is sent. The default is **LOCAL** i.e. to its own channel. Step through the options with this button and set it at **S-C TO G1**. This setting sends its Side-Chain Control Signal to Side-Chain Bus 1.
- 2** The lower button sets where the Side-Chain Control Signal is taken from. The default is **LOCAL** i.e. from its own channel. Step through the options with this button and set it at **SC FM G1**. With this setting, the current channel takes its Side-Chain Control Signal from Side-Chain Bus 1.
- 3** Repeat 1 and 2 above on further channels as desired.

# 4-12 Mixing to the Main Output Bus

## Multi-Channel Main Output Bus in general

The Main Output Bus for the OXF-R3, which doubles as the M/T Monitor Bus, can be used for Stereo or Surround mix-down according to the set-up in the centre section. The set-up procedure is described later in this section.

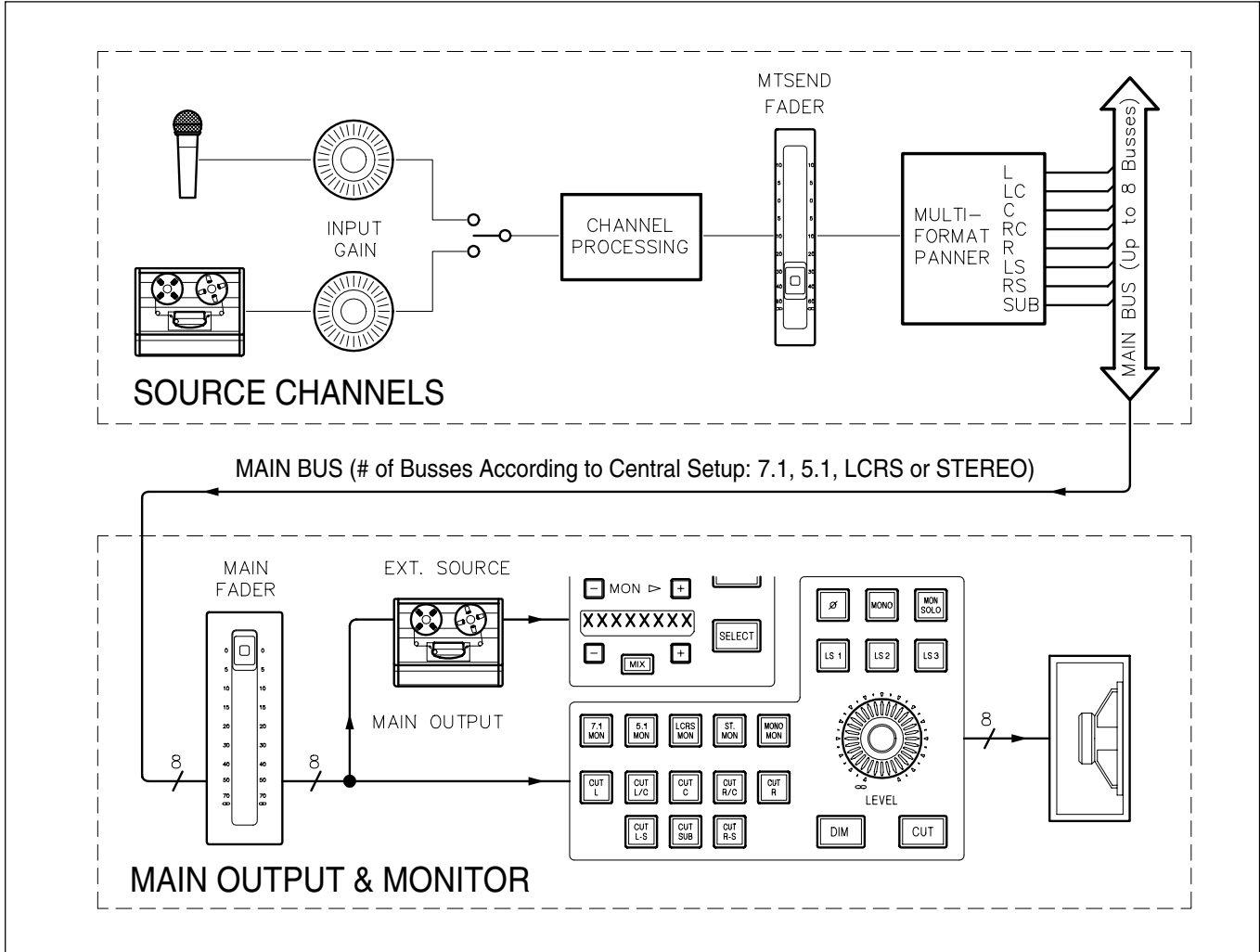

Simplified signal path illustrating the components for mixing to the Multi-Channel Main Output

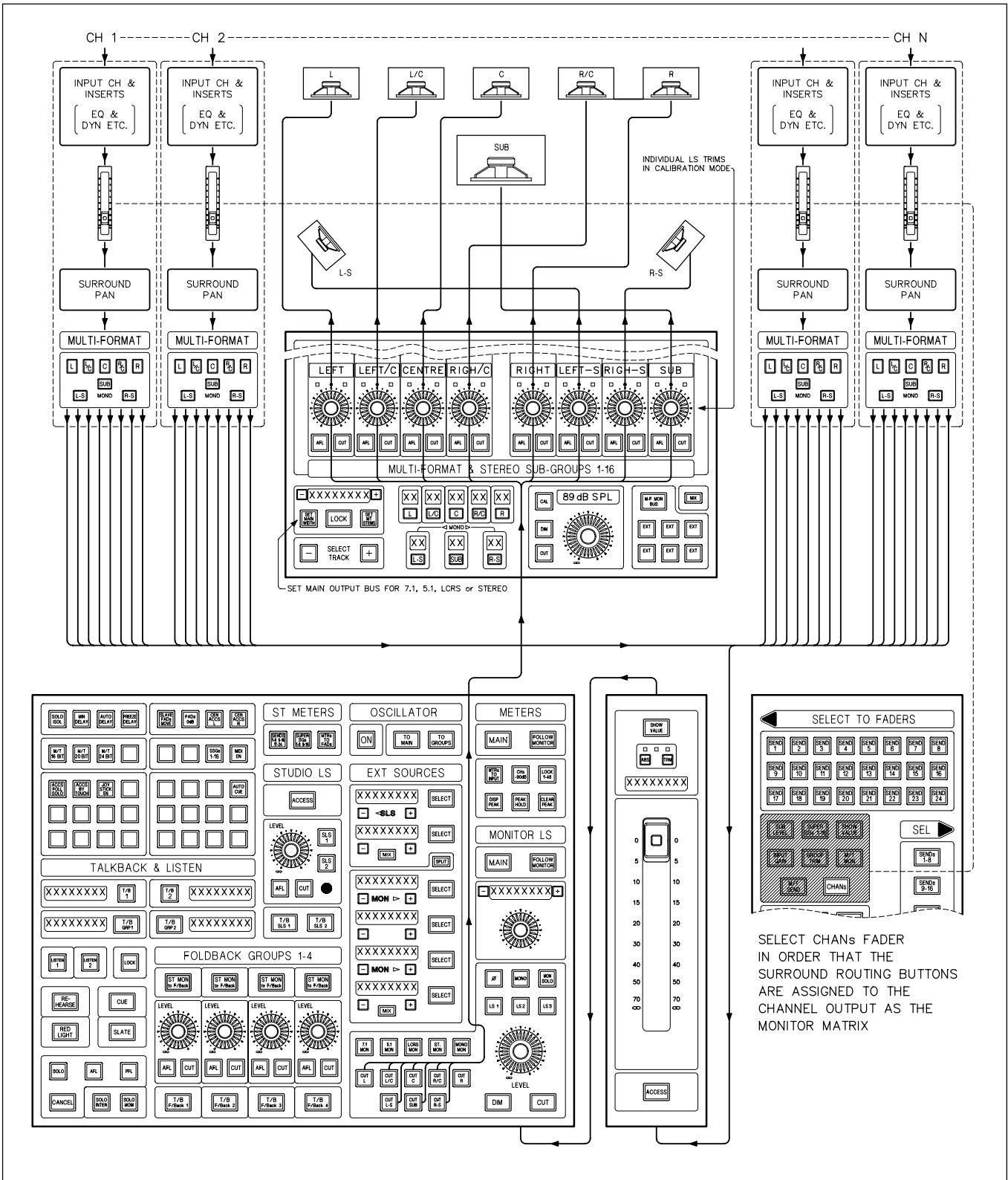

Block Schematic of Stereo and Surround Mix-Down illustrating interconnections of all components, including monitoring

## 4-12 Mixing to the Main Output Bus

### 4-12-1 Main Output Bus Set-up

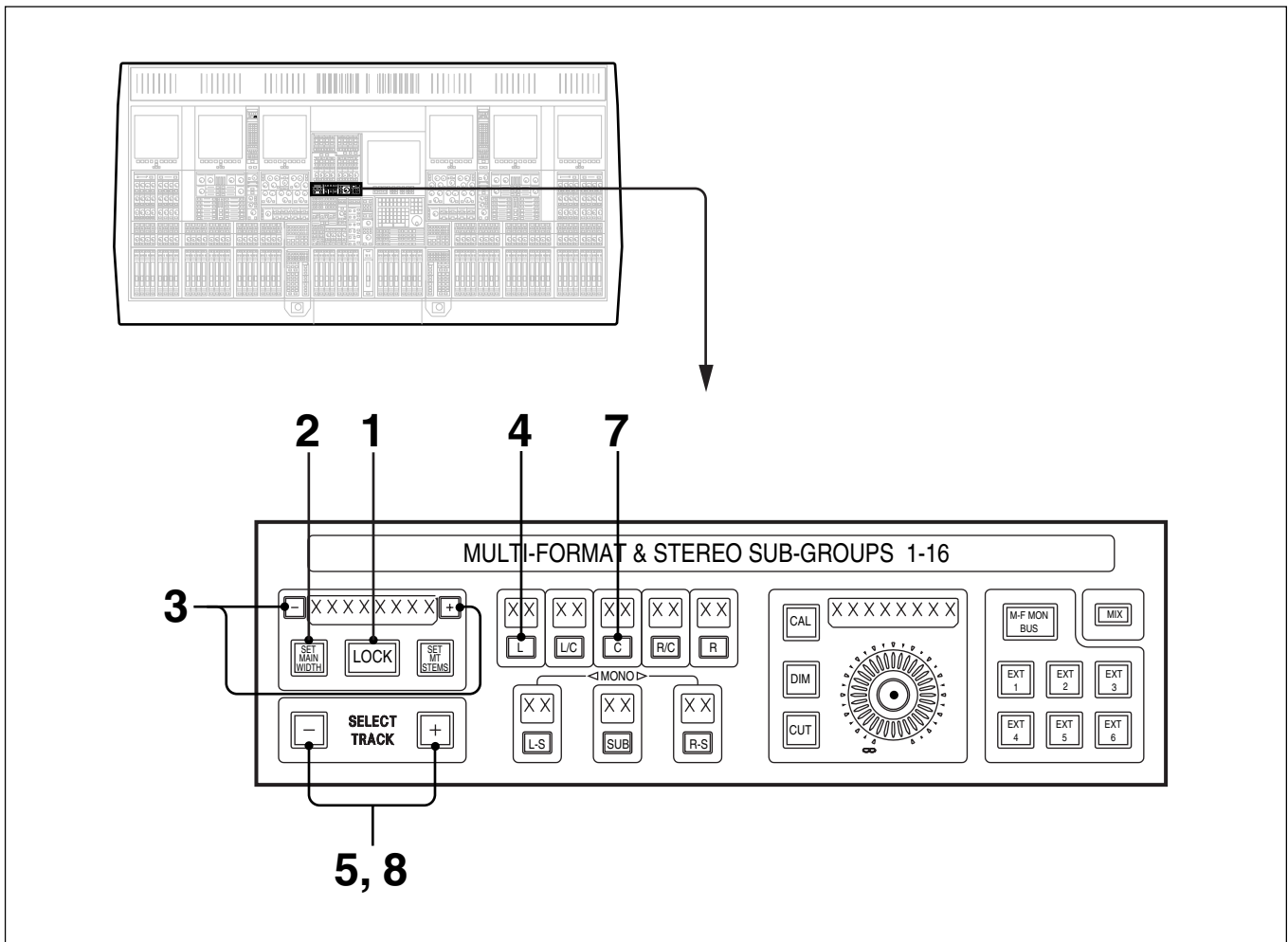

#### Master Section set-up functions

The 8 character dot display to the left of this panel can display the format for the Main Output Bus and that of M/T Stems.

If the **SET MAIN WIDTH** button is lit, the format for the Main Output Bus is displayed: STEREO, LCRS, 5.1 or 7.1. The current format for the Main Output Bus is also displayed in the 8 character display above the central Master fader.

If the **SET MT STEMS** button is lit, the format for the M/T Bus is displayed: STEREO, LCRS, 5.1 or 7.1.

- 1 The **LOCK** push-button is normally lit, indicating that the set-up is locked. Press to unlock indicated by the light going off. This button will time out back to lock status 10 seconds after the last button push.

#### Note

A Config. Set-up option enables the **LOCK** button as a level of security, i.e. it must be unlocked to allow bus assignment set-up.



- 2 While the system is unlocked, press the **SET MAIN WIDTH** button to check the Main Bus width matches requirements, if not already displayed.
- 3 To change it, while the system is unlocked, use the **+** or **-** button to step through the formats: STEREO, LCRS, 5.1 and 7.1 until the desired format is displayed by the 8 character dot display above the **LOCK** push-button. It will also be displayed above the central Master Fader.

### Main Bus to Multitrack

As well as feeding the Main Output to external destinations, the system allows the Main Bus signal to be laid back onto the multitrack if required. But before this can be done, the tracks to be used for this purpose must first be assigned. Continue the set-up as follows:

- 4 The system must be unlocked to assign the multitrack busses which will be fed from the Main Output Bus.

To assign the L channel for example, press and hold the **L** button, and it lights.

- 5 Step through the multitrack busses using the **SELECT TRACK** **+** and **-** buttons until the desired bus number is displayed in the 2 character display above the **L** button. This track has then been assigned for the L channel of the Main Output Bus.
- 6 Repeat steps 4 and 5 for the other destination busses.

### To Clear any Multitrack Bus Destinations

As an example, to clear the bus set up as the C channel:

- 7 Press and hold the **C** button and it lights.
- 8 Press the **SELECT TRACK** **+** and **-** buttons simultaneously to clear the bus assignment for the C channel.

## 4-12 Mixing to the Main Output Bus

### 4-12-2 Channel Signal to the Main Output

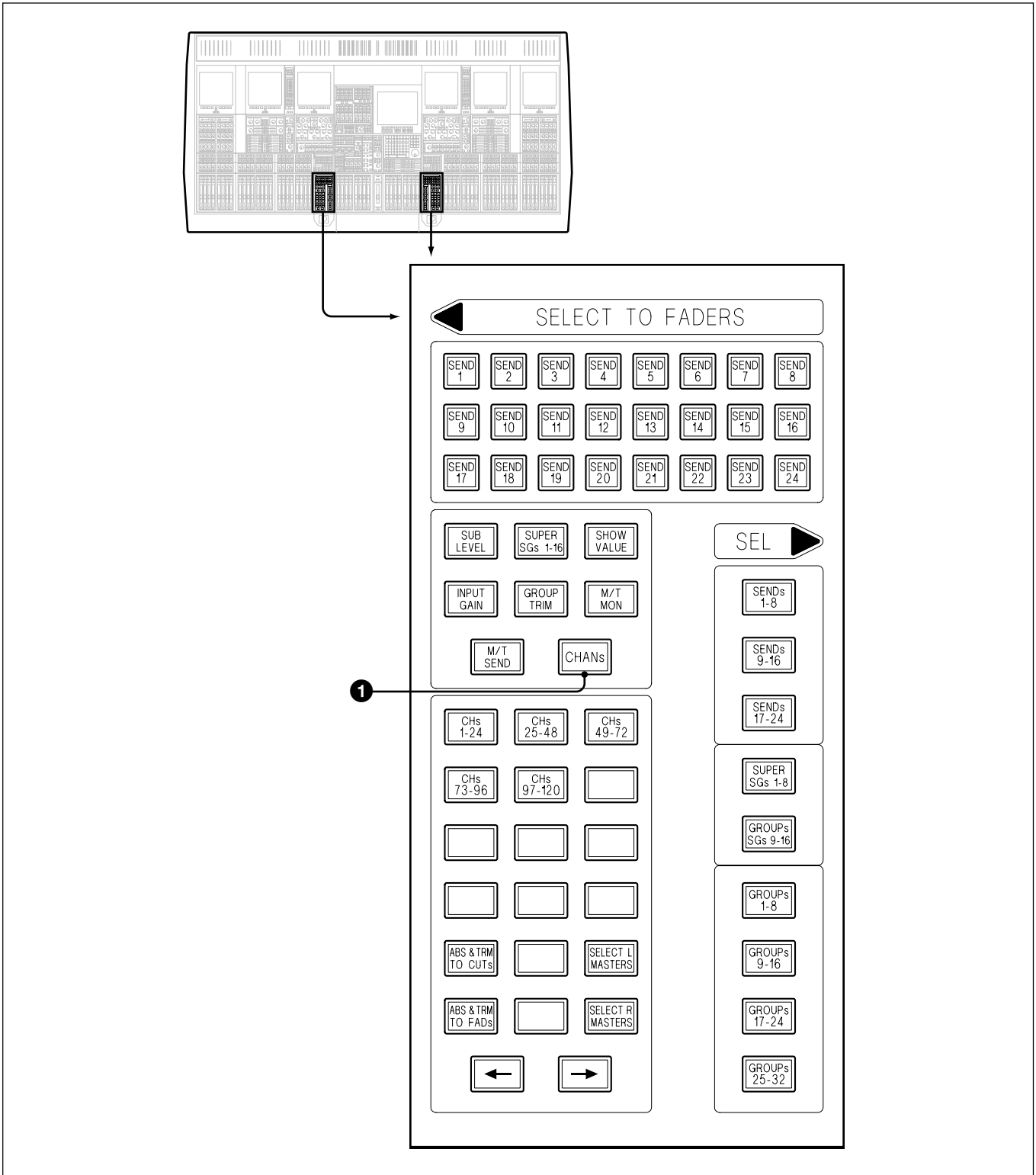

#### ❶ CHANS Push-Button

Sets the faders in the channels sections to control the level of the Channel Outputs to the Main Output Bus. Make sure this button is selected.

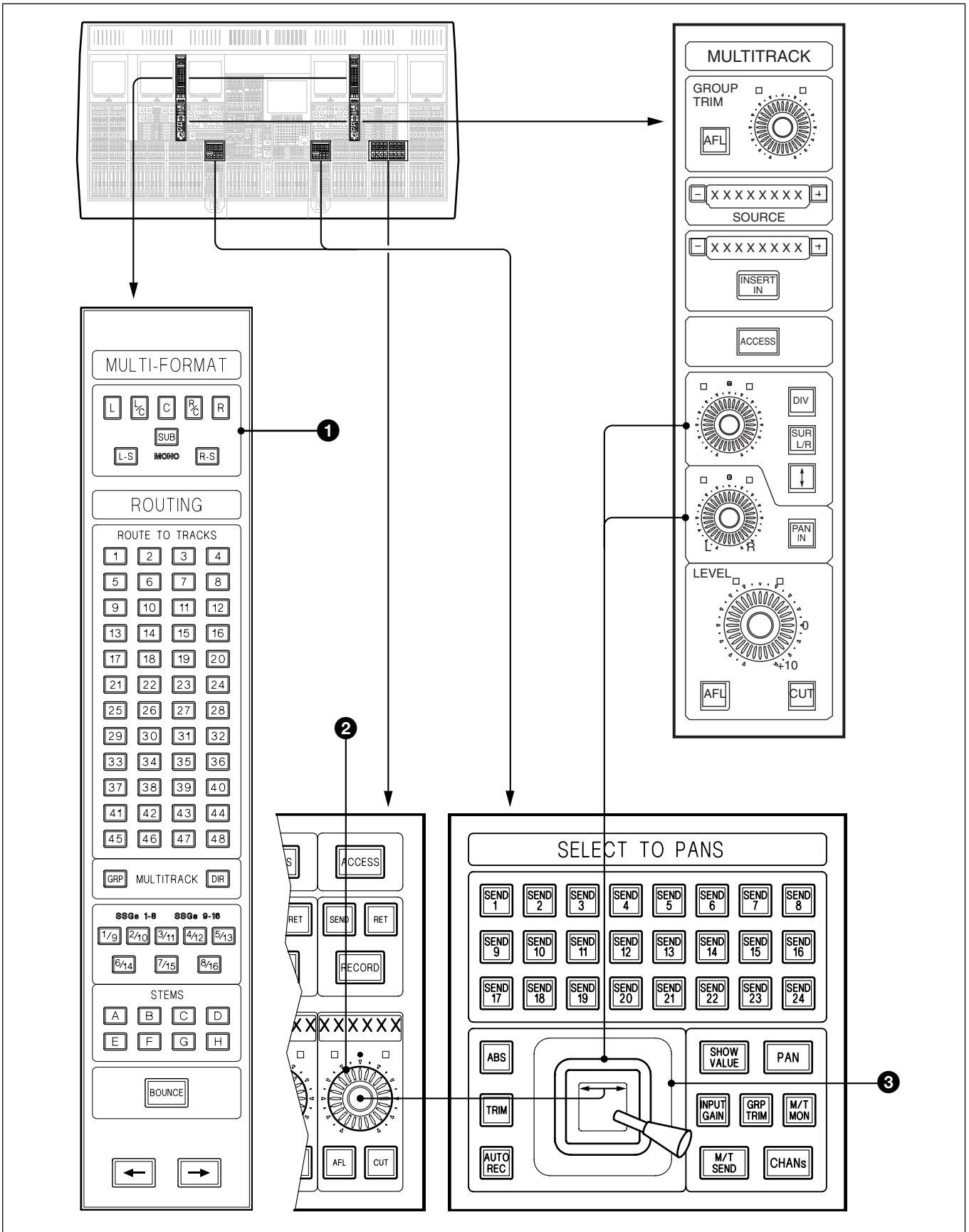

Surround routing and panning when mixing to the Main Output

### Routing, Stereo and Surround Panning in general

The controls used for routing and panning of signals may be assigned to a number of functions including the Channel Output, Multitrack Send and the SSGs (Super Send Groups). The following describes their use when assigned to the Channel Output, by selecting **[CHANS]** on the SELECT TO FADERS panel.

#### ❶ MULTI-FORMAT Routing Push-Buttons

The surround routing buttons are laid out in the form of a surround sound LS layout. Only those consistent with the format selected in the master section will be operable. The fire-up default is Stereo indicated by the L and R buttons being lit.

#### ❷ Definable Knobs

Pan is the fire-up default for the Definable Knobs, indicated by **[PAN]** being lit on the SELECT TO PANS panel. This allows control on a channel by channel basis for L/R pan settings for Stereo and L/C/R for surround modes.

#### ❸ Touch Sensitive Motorised Joystick Panner

Any signal routed to two or more busses can be panned using one of the joysticks, one at each side of the control surface. The joysticks are assigned according to channel **[ACCESS]** buttons. They work in tandem with the Pan knobs on the MULTITRACK panel and the Pan function for the Definable Knobs. All three controls track each other. If one is put into automation write, the others will follow automatically. The joystick will move according to automated moves and the **[AUTO REC]** push-button lights when the joystick is touched.

#### Note

*The Surround Routing buttons in the MULTI-FORMAT section of the Routing panel and panners will always operate on whatever function is assigned to the Faders, via the SELECT TO FADERS panel.*

# 4-13 Multi-Stem Set-up

## MULTI-STEM in general

Recording a stem works in much the same way as recording a mono or stereo signal to multitrack. The differences are having surround sound panning instead of stereo, and the Main Output Bus, which is used as the monitor path, must be set to a suitable surround format.

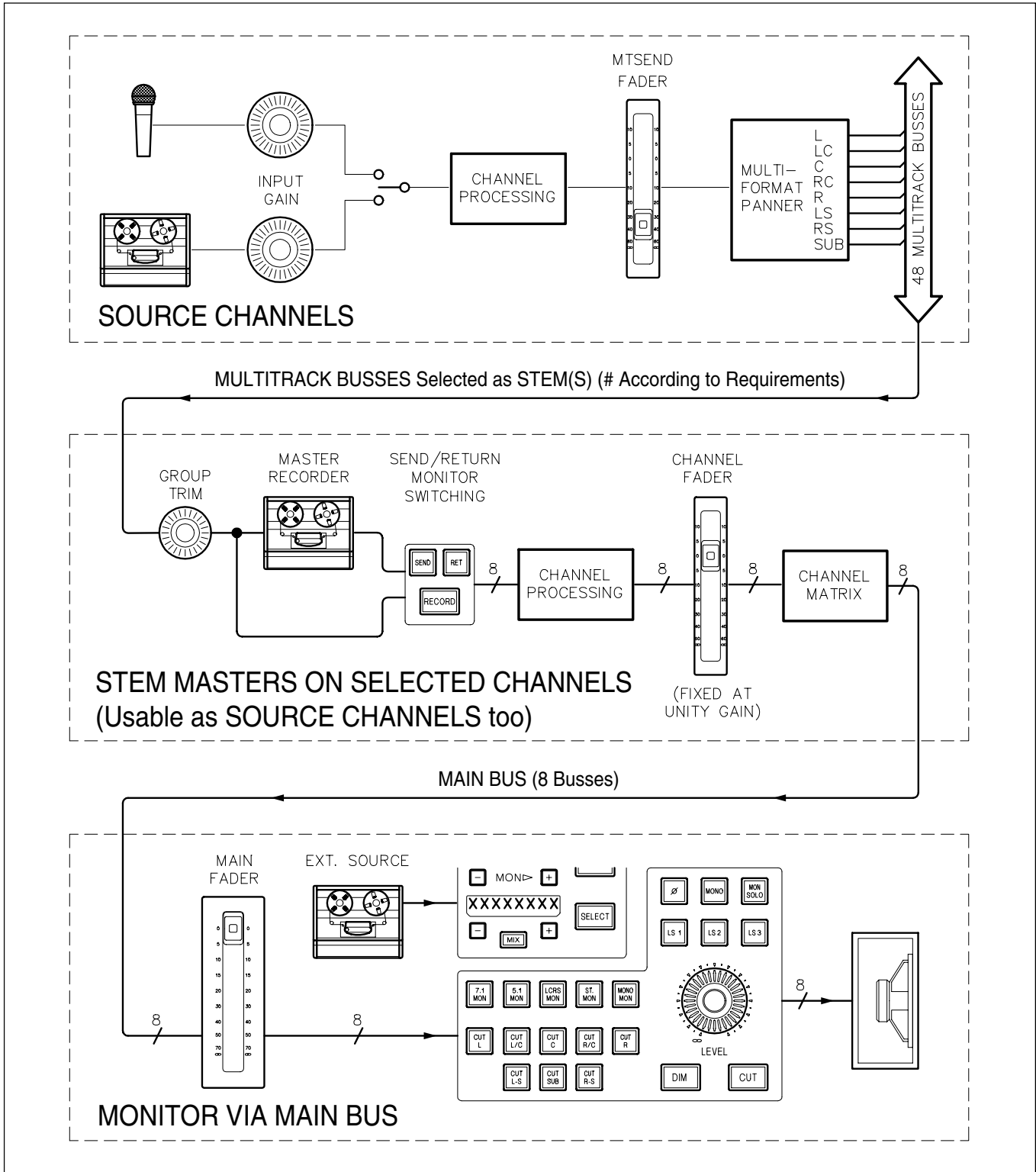

Simplified signal path illustrating the components for mixing to the Multi-Channel Main Output

# 4-13 Multi-Stem Set-up

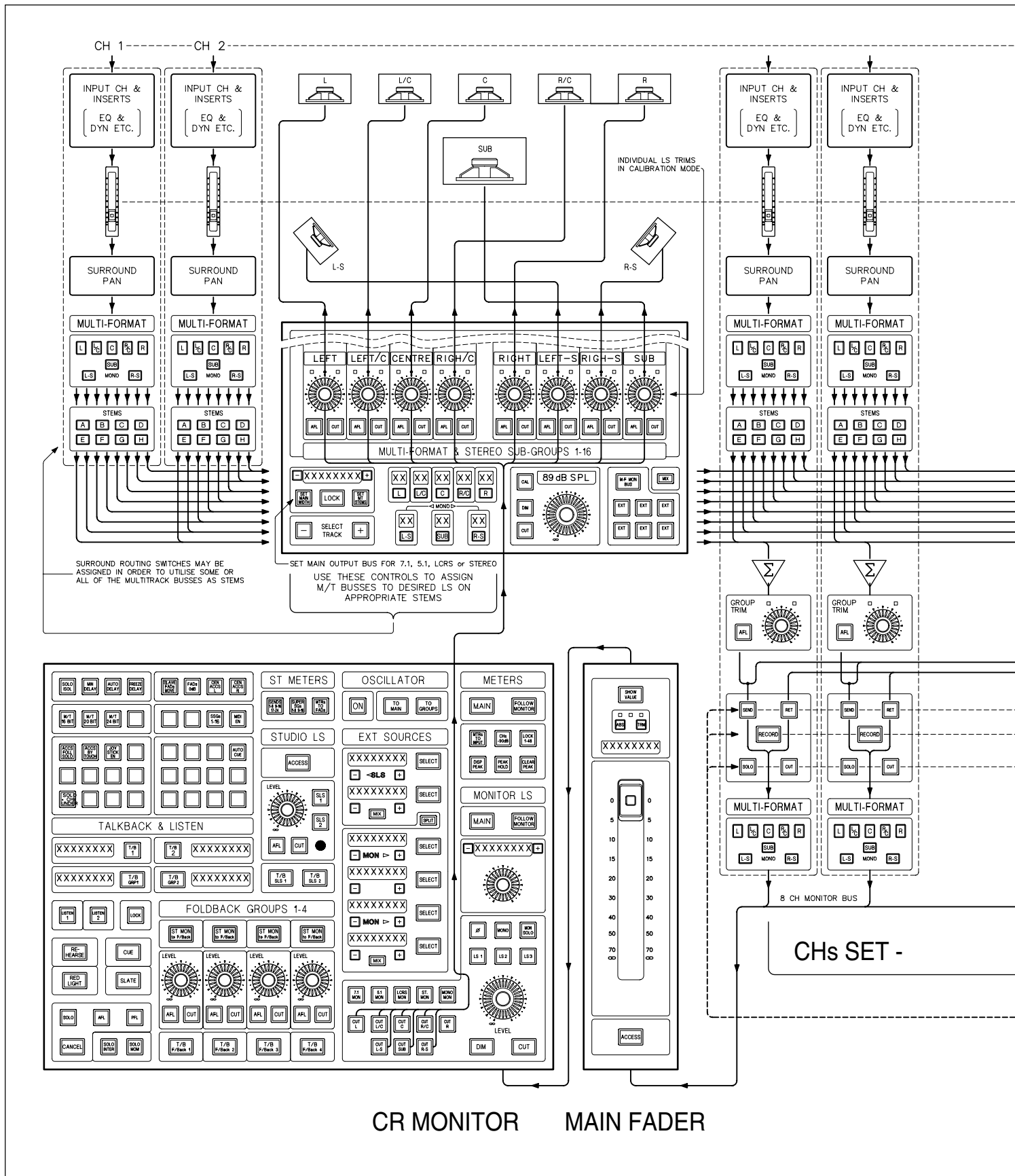

Block Schematic of Multi-Stem Scheme illustrating interconnections of all components, including monitoring

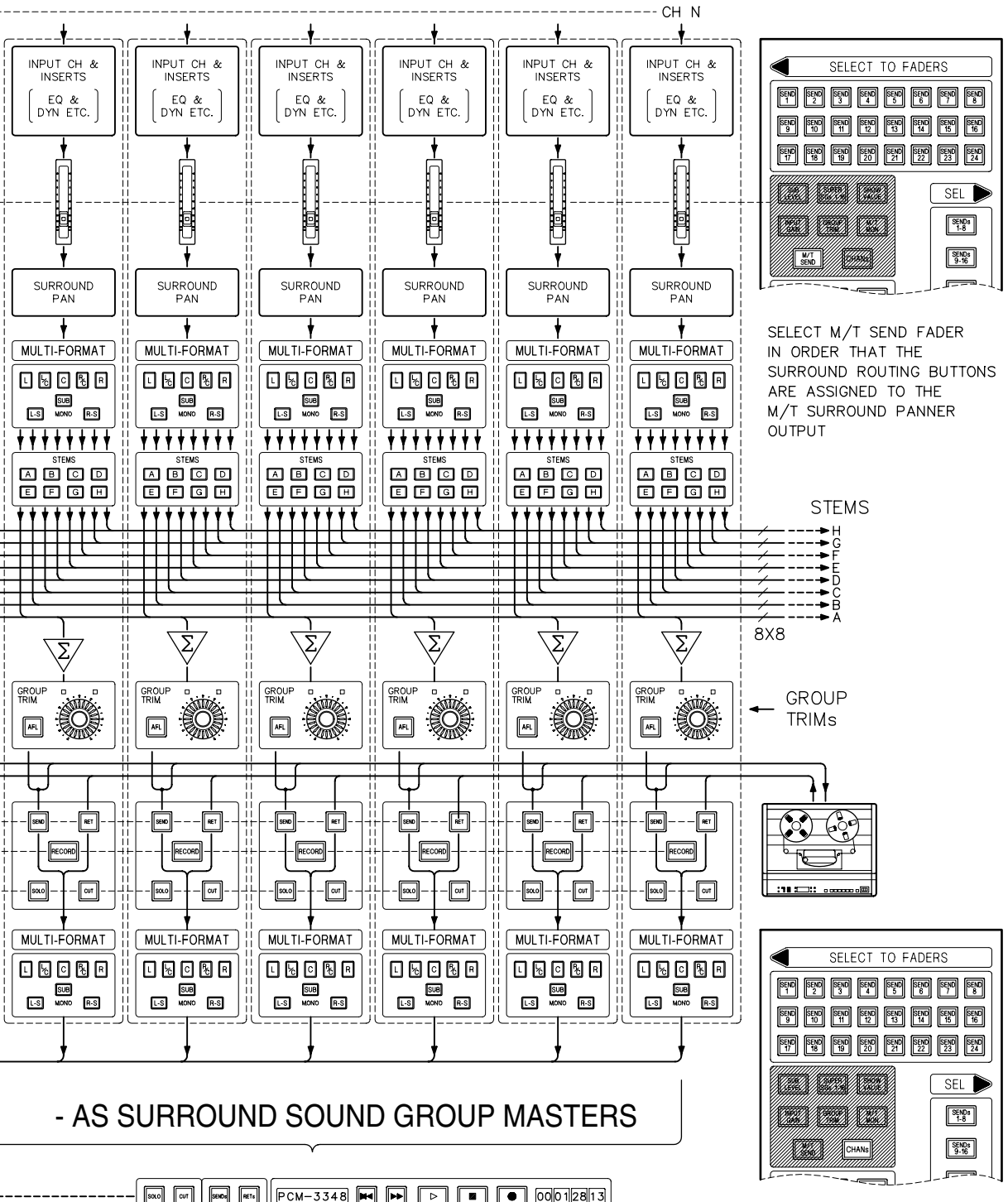

- AS SURROUND SOUND GROUP MASTERS



CHs SET UP AS GROUP MASTERS MAY BE ASSIGNED TO A REMOTE SET VIA GUI SETUP & OPERATED AS AN INDIVIDUAL MACHINE OR PART OF A VIRTUAL MACHINE. THIS ALLOWS GROUPED SOLOS, CUTS, READYs & RECORD FUNCTIONS. ALL OF THESE FUNCTIONS CAN BE CONTROLLED EXTERNALLY VIA GPI

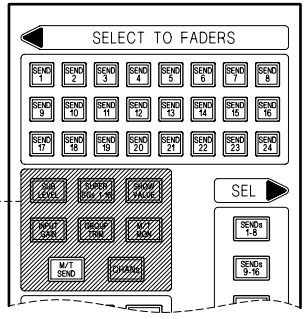

SELECT M/T SEND FADER IN ORDER THAT THE SURROUND ROUTING BUTTONS ARE ASSIGNED TO THE M/T SURROUND PANNER OUTPUT

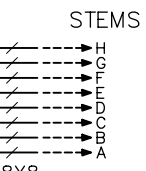

GROUP TRIMS

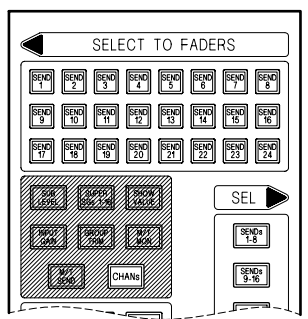
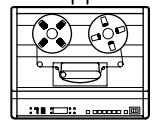

SELECT CHANs FADER IN ORDER THAT THE SURROUND ROUTING BUTTONS ARE ASSIGNED TO THE CHANNEL OUTPUT AS THE MONITOR MATRIX

## 4-13 Multi-Stem Set-up

### 4-13-1 Multi-Stem Set-up Procedure

The Main Output Bus for the OXF-R3, which doubles as the M/T Monitor Bus, has two basic modes of operation, Stereo or Surround. For Stem or Multi-Stem operation the Main Output Bus must be set to a Surround mode. Then M/T Busses can be assigned to stems which are configured automatically to use the Main Output Bus for monitoring purposes.

**Note**

*The width of stems, e.g. the number of busses in stems, is limited to a maximum width no greater than the width of the Main Output Bus.*

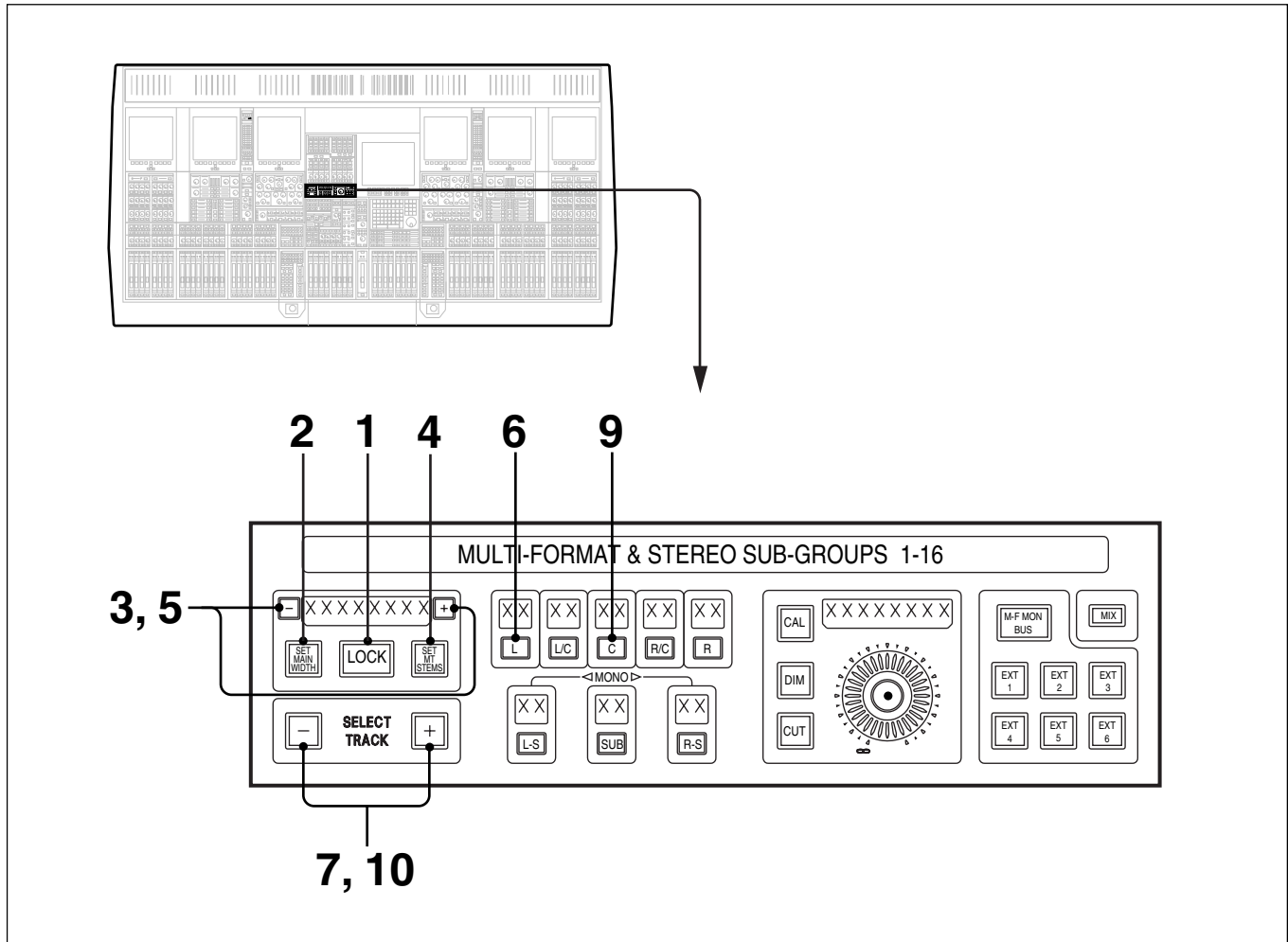

#### Master Section set-up functions

The 8 character dot display to the left of this panel can display the format for the Main Output Bus and that of M/T Stems.

If the **SET MAIN WIDTH** button is lit, the format for the Main Output Bus is displayed: STEREO, LCRS, 5.1 or 7.1.

If the **SET MT STEMS** button is lit, the format for the M/T Bus is displayed: STEREO, LCRS, 5.1 or 7.1. A stem reference, one of A–H, will also be included if surround is in operation.



- 1 The **LOCK** push-button is normally lit, indicating that the set-up is locked. Press to unlock, indicated by the light going off. This button will time out back to lock status 10 seconds after the last button press.

**Note**

*A Config. Set-up option enables the **LOCK** button as a level of security, i.e. it must be unlocked to allow bus assignment set-up.*

- 2 While the system is unlocked, press the **SET MAIN WIDTH** button to check that the Main Bus width matches requirements if not already displayed.
- 3 If it does not, while the system is unlocked, use the **+** or **-** button to step through the formats: STEREO, LCRS, 5.1 and 7.1 until the desired format is displayed by the 8 character display above the **LOCK** push-button.
- 4 While the system is unlocked, press the **SET MT STEMS** button.
- 5 While the system is unlocked, use the **+** or **-** button to step through the formats: STEREO, LCRS, 5.1 and 7.1 until the desired type is displayed by the 8 character display above the **LOCK** push-button. An 'A' will be displayed initially to the right along with each format type, indicating that the settings displayed are for Stem A. If the system has already been in use, then other letters, B-H, may be displayed depending on how the system was left.

To select another Stem make sure that **LOCK** is lit, by pressing it or allowing it to 'time out', then use the **+** or **-** buttons either side of the 8 character display to step through stems A-H.

- 6 Multitrack busses are used as Multi-Stem master busses and must be selected as part of the set-up. The system must be unlocked to assign the multitrack busses.

To assign the L channel for example, press and hold the **L** button, and it lights.

- 7 Step through the multitrack busses using the **SELECT TRACK** **+** and **-** buttons until the desired bus number is displayed in the 2 character display above the **L** button. This track has then been assigned for the L channel for the Stem, one of A-H, indicated in the 8 character display. The track button in the ROUTE GUI will display a colour-coded outline, indicating that it has been assigned to a Stem.
- 8 Repeat steps 6 and 7 for the other busses required in the current Stem.

To assign busses for another Stem, make sure that **LOCK** is lit, by pressing it or allowing it to 'time out'. Then use the **+** or **-** buttons either side of the 8 character display to step through Stems A-H to the one which is required. Then repeat steps 6 and 7 for each of the busses required in that Stem.

### To Clear any Busses set up in Stems

As an example, to clear the bus set up as the C channel:

**9** Press and hold the  button and it lights.

**10** Press the SELECT TRACK  and  buttons simultaneously to clear the bus assignment for the C channel.



# 4-13 Multi-Stem Set-up

## 4-13-2 Multi-Stem Monitor Path

The channels which relate to the multitrack busses in stems need to be set up as the monitor path for each stem.

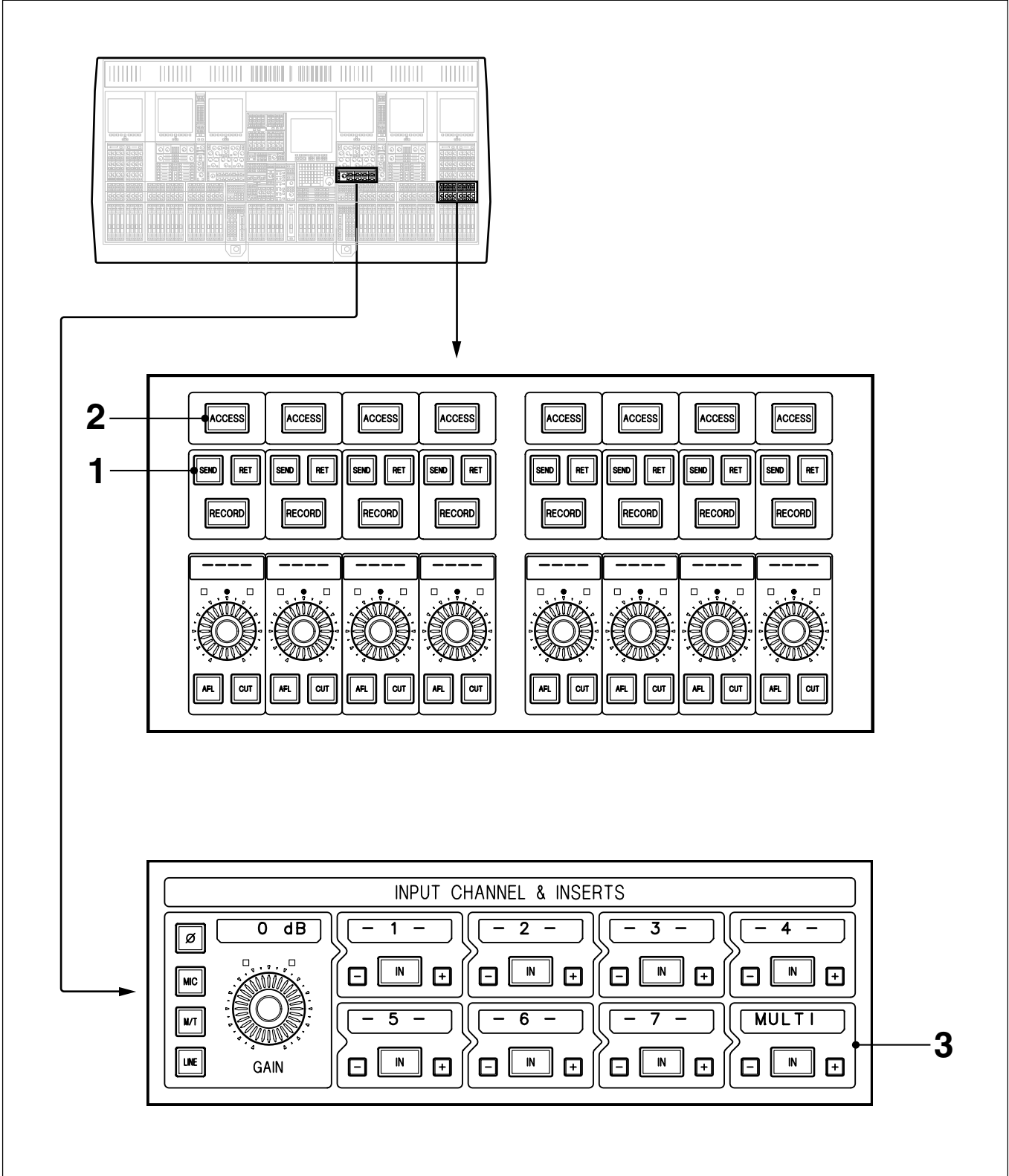

- 1 The **SEND** push-buttons relating to the Multi-Stem (multitrack) busses will be selected automatically during the master set-up.

**Note**

*In Multi-Format Mode the **SEND** and **RET** buttons for channels assigned as Stem masters inter-cancel.*

- 2 Select **ACCESS** for each Stem Master channel in turn.
- 3 Step through the options in box 8 for each stem channel on the Input Channel & Inserts panel until MULTI is shown in the 8 character display. Select its **IN** button. This will ensure that any processing inserted in boxes 1-7 will affect what is recorded via Stem Masters.

### Unity Gain Monitor Path using FADS 0dB Push-Button

The Main Output Bus is used in the monitor path via the Channel Faders which may be freely adjusted. In order to lock Channel Faders for Stem Master Channels at unity gain:

- 4 Make sure **CHANS** is selected at the SELECT TO FADERS panel (refer to 6-2-2 for details of SELECT TO PANELS operation).
- 5 Press the **FADS 0dB** in the central Monitor panel and it flashes on and off (refer to 6-3-2 for details of **FADS 0dB** operation).
- 6 Press **ACCESS** at the bottom of the fader for each of the Stem Masters. Their faders will move to the 0dB point and will spring back to unity, if moved and released. **ACCESS** buttons will light amber.
- 7 Press the **FADS 0dB** to resume normal operations and faders will spring back.

**Note**

*When used this way the **FADS 0dB** function will not be affected by the loading of Snapshots, in that the 0dB locked fader settings cannot be overwritten.*

### Unity Gain settings and Snapshots

To allow the unity gain settings for Stem Master Channel Faders to be overwritten with Snapshots, the procedure is modified slightly:

- 5 Press the **FADS 0dB** and it flashes on and off.
- 6 Press **ACCESS** at the bottom of the fader for each of the Stem Masters. Their faders will move to the 0dB point and will spring back to unity if moved and released. **ACCESS** buttons will light amber.
- 7 Press **ACCESS** buttons again to release them from the 0dB function. They are no longer lit. Do not touch faders in order that they remain at 0dB, they will not spring back to the unity gain setting automatically.
- 8 Press the **FADS 0dB** to resume normal operations but note that the faders will not spring back if moved.

# 4-13 Multi-Step Set-up

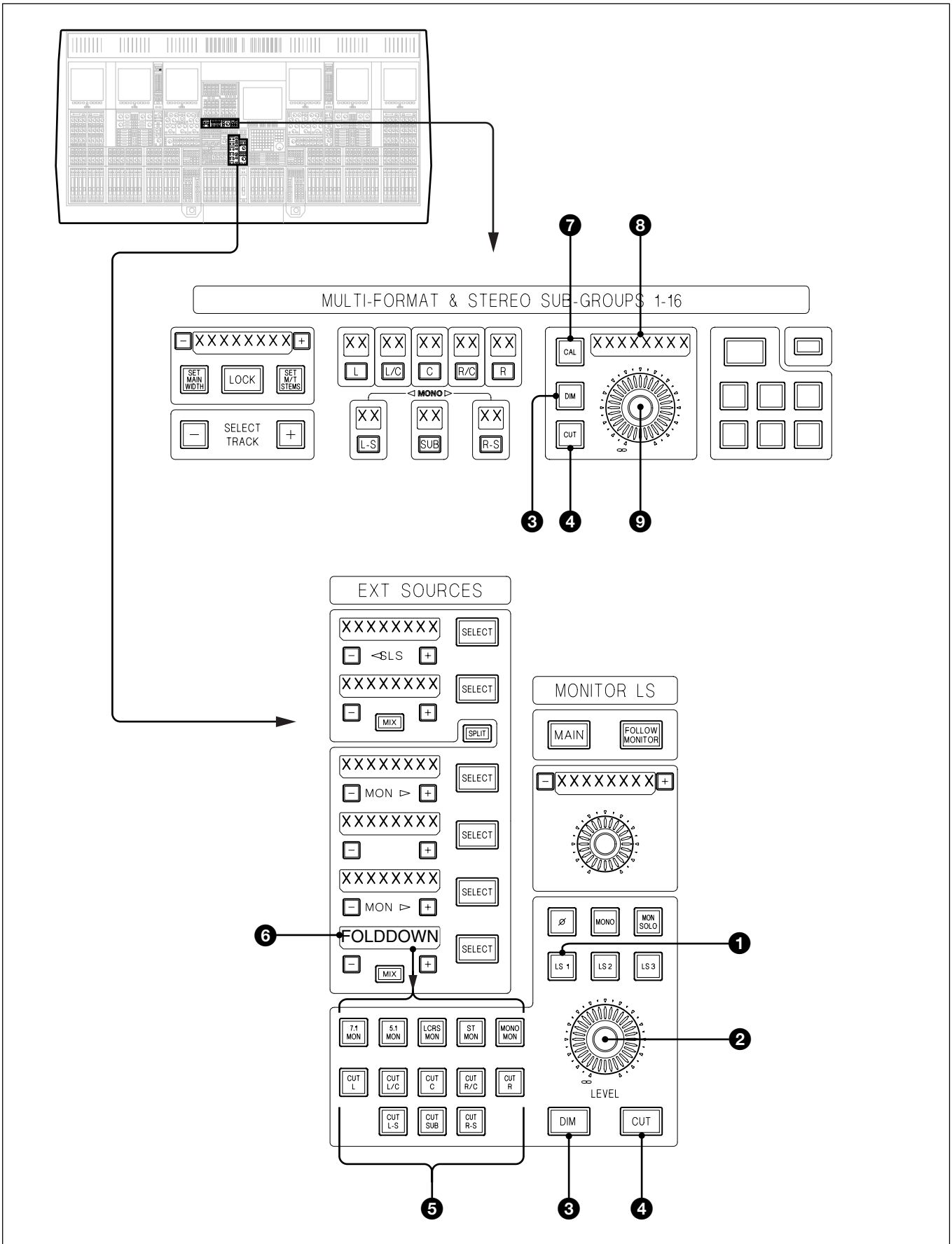

Once the Stem Masters have been set up on channels make sure the central Master Fader is set to maximum, 0dB. Then the monitor signal is available via the centre section controls as follows:

**Note**

*What follows is an overview of the Monitor functions. For detailed descriptions of individual functions, see Chapter 6.*

**1 LS1 Push-Button**

Selects the primary set of Monitor LS and is the fire-up default. Make sure the **[LS 1]** button is lit, or press it if not.

**2 CR Monitor Level**

Sets the level to the Control Room LS and operates in tandem with the Surround Level **9**, on the upper panel illustrated on the page opposite.

**3 DIM Push-Buttons**

Dims the CR Monitor LS according to the Dim setting, adjusted using the small definable knob situated above **2**.

**4 CUT Push-Buttons**

Cuts all the CR Monitor LS simultaneously.

**Note**

**[DIM]** and **[CUT]** are situated in both panel sections and work in tandem.

**5 CUT L – CUT R-S Push-Buttons**

Individual CR Monitor LS mutes.

**6 Surround Fold-Down Matrix**

The monitor signal fire-up default is the Main Output Bus. It is possible to listen to a folded down version of the Main Output Bus as follows:

- Select FOLDDOWN as the source in one of the EXT SOURCE windows using the **[+]** and **[-]** buttons either side of their 8 character dot display.
- Press to light the **[SELECT]** button to the right of that Source Selector.
- Select folded down versions of the Main Output Bus as desired and note that only sources of the same width or less than that of the Main Bus format are valid.

**7 CAL Push-Button**

Toggles between a fixed calibrated setting and the variable setting of the knob **9**.

**8 8 Character Dot Display**

Indicates the level in dB SPL, provided the system has been calibrated correctly. The Calibration Procedure is described in Appendix A-3.

**9 Level Knob**

Adjusts the levels for all LS simultaneously when **[CAL]** is not lit. To change the CAL setting, push, hold and adjust accordingly, then release.

## 4-13 Multi-Stem Set-up

### 4-13-3 Multi-Stem Source Channels

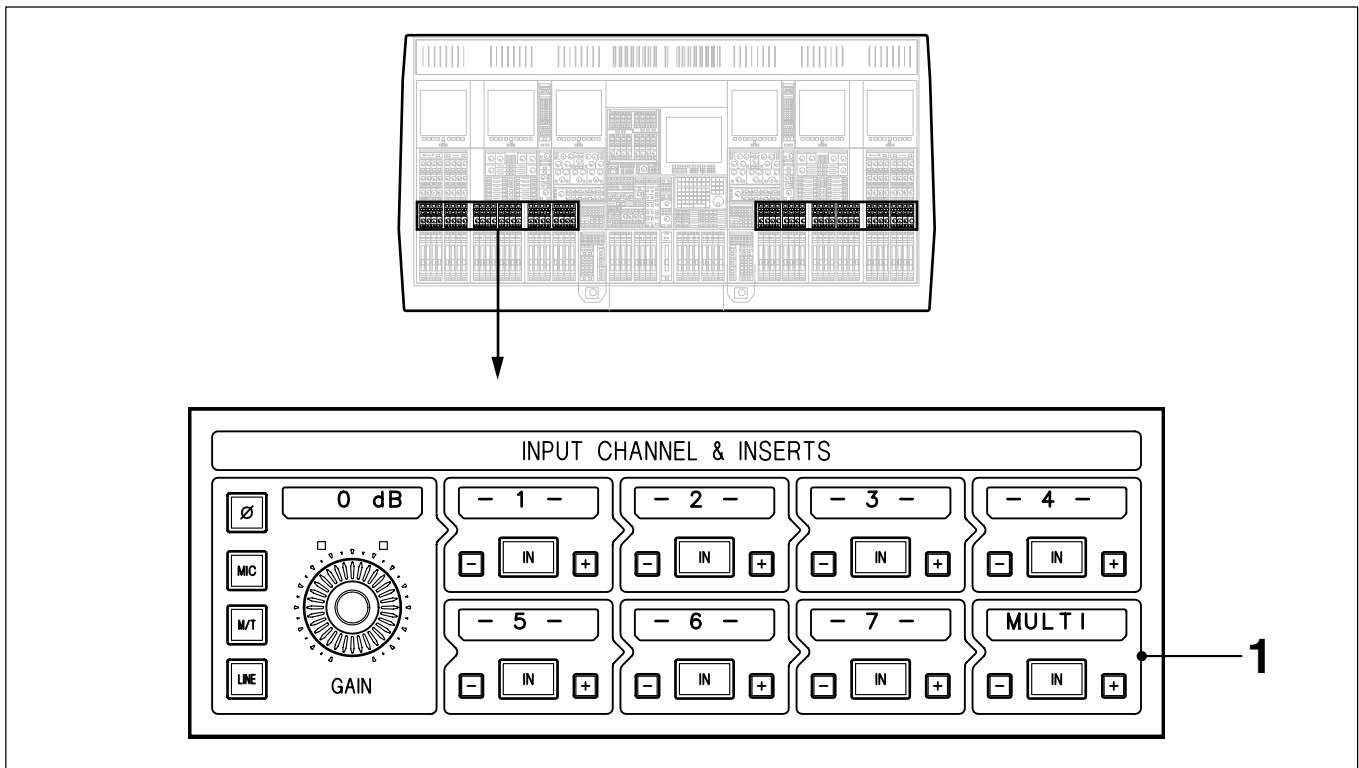

#### Setting up source channels

- 1 Select MULTI in box 8 for each source channel using the **+** and **-** buttons. Select its **IN** button. This set-up ensures that all processes assigned to boxes 1-7 affect the source signal sent to tape.

#### Note

*The channel paths for channels set up as Multi-Channel monitors sections may also be used as source channels.*



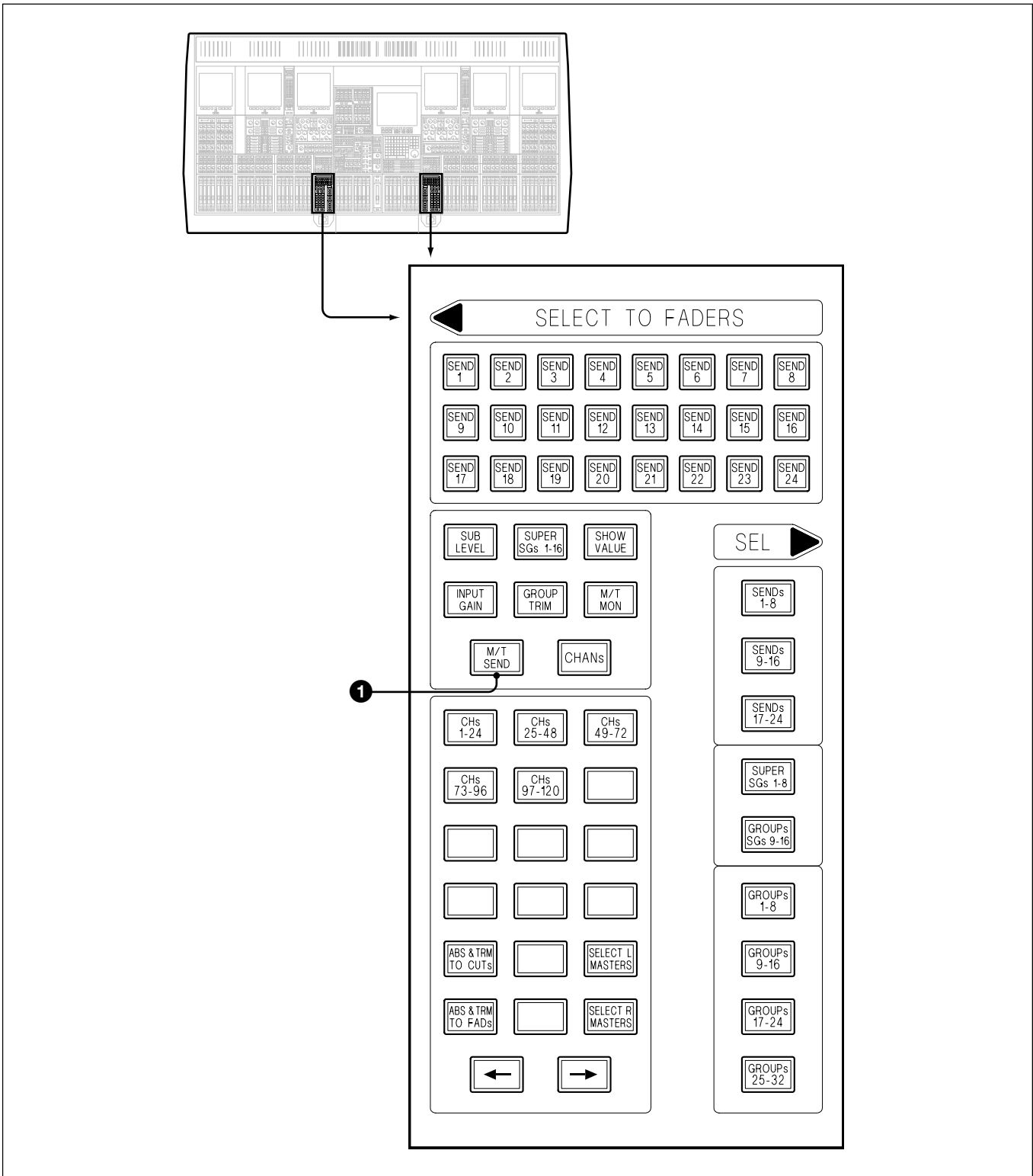

**1 MT SEND Push-Button**

Sets the faders in the channels sections to control the level of the Multitrack Sends which feed the M/T Busses set up as Stems. Make sure this button is selected before proceeding.

# 4-13 Multi-Step Set-up

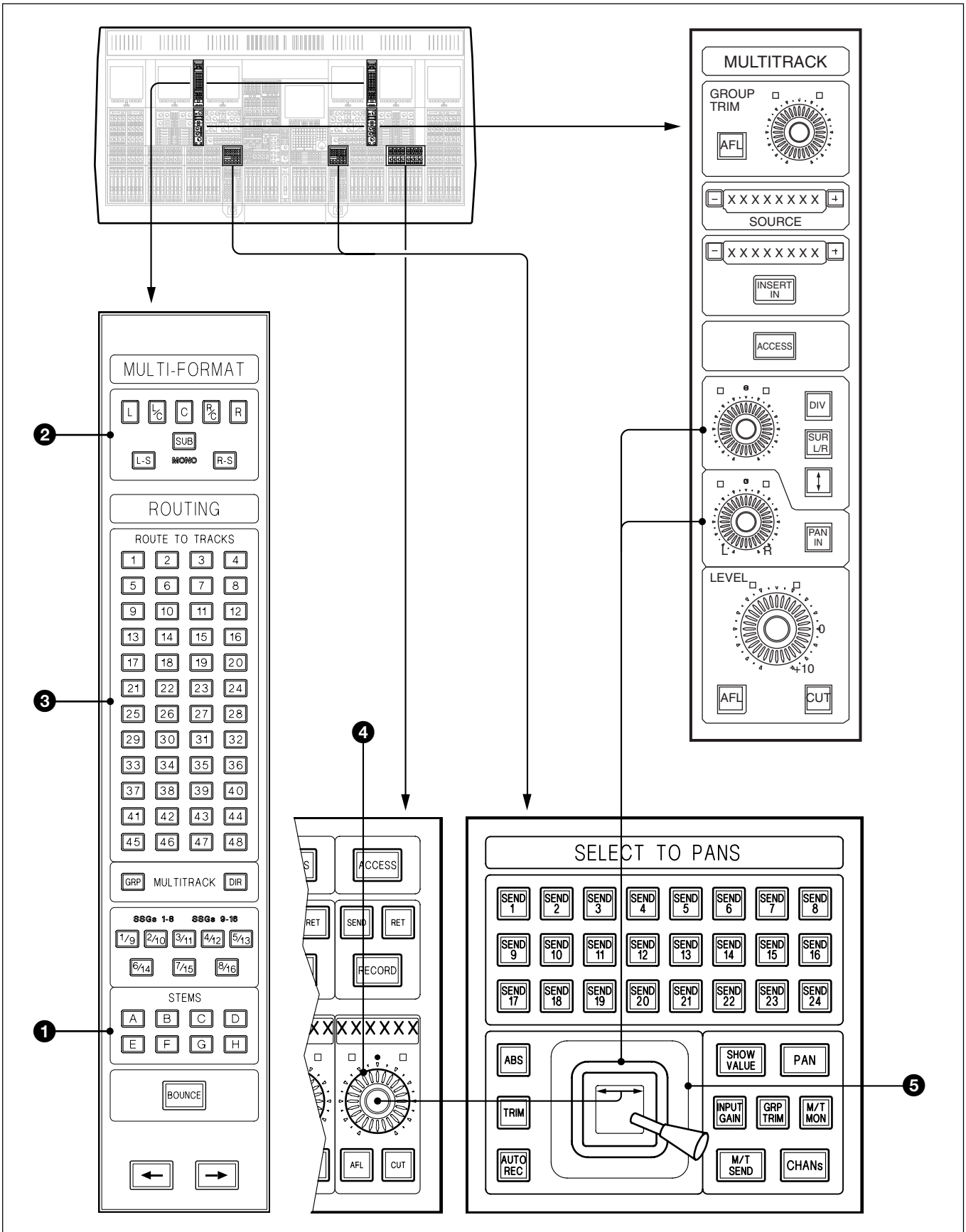

Multi-Channel routing and surround panning

## Multi-Channel routing and surround panning

The following applies to the channels which are the sources for Multi-Channel Stems.

### ❶ STEMS

Press one of A-H to select the desired stem destination. The button will light and its button in the ROUTE GUI will turn red. Buttons A-H inter-cancel. The system can be configured, via the 'Config' set-up file, so that routing selections for the current Stem are cleared automatically on selection of another Stem.

### ❷ MULTI-FORMAT Routing Buttons

The surround routing buttons are laid out in the form of a surround sound LS layout. Only those consistent with the format selected in the master section will be operable. They are assigned to buttons in the ROUTE TO TRACKS section in the Multi-Format set-up.

When a surround routing button is selected, it lights and so does the track button which is assigned to it in the set-up. The ROUTE GUI reflects this operation too by highlighting both buttons in red.

### ❸ ROUTE TO TRACKS Routing Buttons

Allow routing selections direct to Tracks, independent of whether a Track is assigned to a Stem.

### ❹ Definable Knobs

Pan is the fire-up default for the Definable Knobs, indicated by **PAN** being lit on the SELECT TO PANS panel. This allows control on a channel by channel basis for L/R pan settings for Stereo and L/C/R for surround modes.

### ❺ Touch Sensitive Motorised Joystick Panner

Any signal routed to two or more busses can be panned using one of the joysticks, one at each side of the control surface. The joysticks are assigned according to channel **ACCESS** buttons. They work in tandem with the pan knobs on the MULTITRACK panel and the L/R Pan above the faders, when faders are assigned to control M/T Send level. Any Pan can be used as they all track each other. If one is put into automation write, the others will follow automatically. The joystick will move according to automated moves and the **AUTO REC** push-button lights when the joystick is touched.

#### Note

*The Surround Routing buttons in the MULTI-FORMAT section of the Routing panel and panners will always operate on whatever function is assigned to the Faders, via the SELECT TO FADERS panel.*

*The functions of the individual controls on these panels are described in more detail in Chapter 6.*

### Behaviour of Routing in general.

The routing options and behaviour vary considerably depending on whether the system is operating in STEREO or MULTI-FORMAT modes. What follows is a summary:

#### STEREO Mode

'ROUTE TO TRACKS' section ③ allows panning strictly between Odd and Even tracks only. MULTI-FORMAT buttons ② are not operational.

- **Selecting either just ODD or EVEN tracks.**

A Post Fader signal will be fed directly to the Odd or Even tracks. The M/T **PAN IN** button is not operational.

- **Selecting at least one ODD and one EVEN track.**

A Post Fader signal will be fed directly to the Odd and Even tracks. Selecting the M/T **PAN IN** button will allow panning between the Odd and Even tracks.

#### MULTI-FORMAT Mode

Routing to busses can be accomplished in several ways:

- Using the MULTI-FORMAT section buttons ② at the top of the panel, which are mapped onto the track buttons stem by stem.
- Using the 'ROUTE TO TRACKS' buttons directly.
- A mixture of the two above to multiple stems.

#### ROUTING SELECTIONS for the ACTIVE STEM

The 'Active Stem' is the one selected and lit in section ①.

- **Selecting a single button in the MULTI-FORMAT section ②**

The track button, one of 1-48, mapped in the stem set-up to the one pressed, will light and a Post Fader signal will be fed directly to that track. The M/T **PAN IN** button is not operational.

- **Selecting two buttons in the MULTI-FORMAT section ②**

The track buttons, two of 1-48, mapped in the stem set-up will light and a Post Fader signal will be fed directly to those tracks. Selecting the M/T **PAN IN** button will allow panning between those tracks, using the PAN in the Multitrack panel or the Definable knobs, one above each fader.

The full range of the PAN knob is operational between the tracks whilst the Motorised Joystick will be mapped to the shortest path. If the Joystick is moved out of that path it will spring back when released.

#### Note

The **JOYSTICK EN** button must be selected in the centre section for the Joysticks to be operational.

- **Selecting more than two buttons in the MULTI-FORMAT section ②**

The track buttons, from 1-48, mapped in the stem set-up will light and a Post Fader signal will be fed directly to those tracks. Selecting the M/T **[PAN IN]** button will allow panning between those tracks as follows:

- The Motorised Joystick will be mapped to the exact area between the buttons. If the Joystick is moved out of that area it will spring back when released.

Panning using the knobs in the Multitrack panel works according to which routing buttons are selected. The Definable knobs, one above each fader, are also operational, affecting front panning:

(The assignable knob in the Multitrack panel has three functions, Front/Back Pan, Surround Pan and Divergence)

- The L/R Pan knob operates across **[L]**, **[L/C]**, **[C]**, **[R/C]** and **[R]**.
- The Surround Pan, select **[SUR L/R]**, operates across **[L-S]** and **[R-S]**.
- Select the button **↕**, to pan the signal front to back.
- Select **[DIV]** to set the Divergence, clockwise for minimum spread.

### ROUTING SELECTIONS for OTHER STEMS

The 'Active Stem' is the one selected and lit in section ①. It is possible to route to other stems by selecting appropriate track numbers directly in the ROUTE TO TRACKS section ③.

- **Selecting one or more buttons in the ROUTE TO TRACKS section**  
Post Surround Pan signals will be fed to tracks according to the pan settings for the Active Stem.

### OTHER ROUTING SELECTIONS

Signals may be routed to tracks which are not set up in any of the Stems.

- **Selecting a single button in the ROUTE TO TRACKS section**  
A Post Fader signal will be fed directly to the track.
- **Selecting two buttons in the ROUTE TO TRACKS section**  
A Post Fader and Front L/R Pan signal will be fed to the two tracks. The L signal is fed to the lowest number track and the R to the highest.
- **Selecting more than two buttons in the ROUTE TO TRACKS section**  
A Post Fader and Front L/R Pan signal will be fed to the tracks. The L signal is fed to the lowest number track and the R to the rest of the higher number tracks.

## 4-13 Multi-Stem Set-up

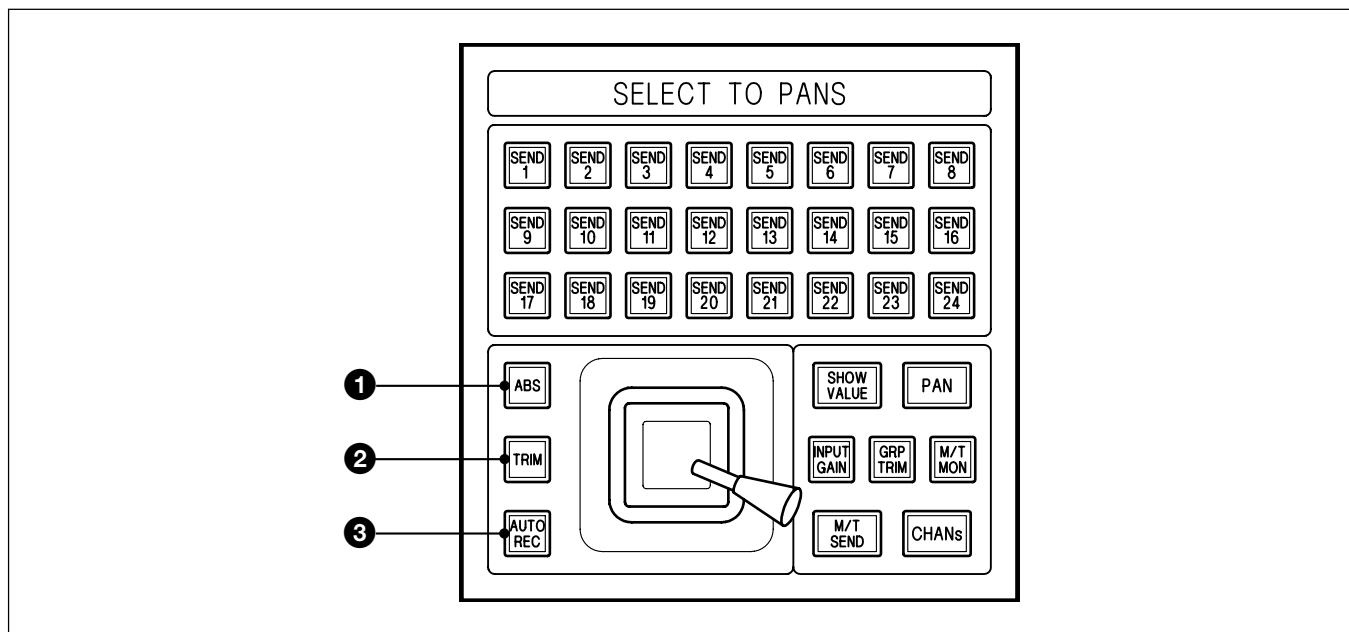

Automation switches for the Motorised Joysticks

### ❶ ABS Push-Button

Used to select 'ready absolute' status when automating joystick panning movements. The automation functions are exactly the same as those for faders (see Chapter 7).

### ❷ TRIM Push-Button

Used to select 'ready trim' status when automating joystick panning movements. The automation functions are exactly the same as those for faders (see Chapter 7).

### ❸ AUTO REC Push-Button

Used to switch the joystick into automation record according to the ABS or TRIM status. The automation functions are exactly the same as those for faders (see Chapter 7). This button lights to indicate that the joystick is being touched.

## Routing and monitoring a signal

Once the set-up operations described earlier in this section have been completed:

- 1** Select **(M/T SEND)** on the SELECT TO FADERS panel and adjust faders on source channels to suitable level settings.
- 2** Select suitable destinations for the source channels using the MULTI-FORMAT routing buttons.
- 3** Monitor the levels visually on the meters related to the channels set up as Multi-Format Masters.
- 4** Listen to the mix via the Multi-Format Monitor described previously in 4-13-2.

### Sub Level

The level control for signals sent to the Sub channel works in two modes, depending on the routing selection.

#### Routed to SUB only

When the **(SUB)** routing button alone is selected for a channel, the level is controlled using the M/T Send Fader. Select **(M/T SEND)** on the SELECT TO FADERS panel.

#### Routed to SUB and other destinations

When the **(SUB)** routing button is selected along with at least one other routing button for a channel, the level is controlled using the M/T Send Fader and can be trimmed using the Sub Level Fader. Select **(M/T SEND)** or **(SUB LEVEL)** accordingly on the SELECT TO FADERS panel.

#### Note

*The setting of the Sub Level Fader will depend upon the sequence of button presses. If **(SUB)** is selected first followed by one or more other routing buttons, the Sub Level Fader will be set at unity gain or 0dB. If **(SUB)** is selected after one or more routing buttons, then the Sub Fader will be set at infinity or fully closed.*

## 4-13 Multi-Stem Set-up

### 4-13-4 Stem Monitor Switching

Once stems have been set up, the tape sends and returns for each stem can be switched in tandem. The switching is operable in several ways, using the SENDS and RETS buttons by the machine remotes or using external switches linked to GPI (General Purpose Interface) connections. Switches may be operated locally.

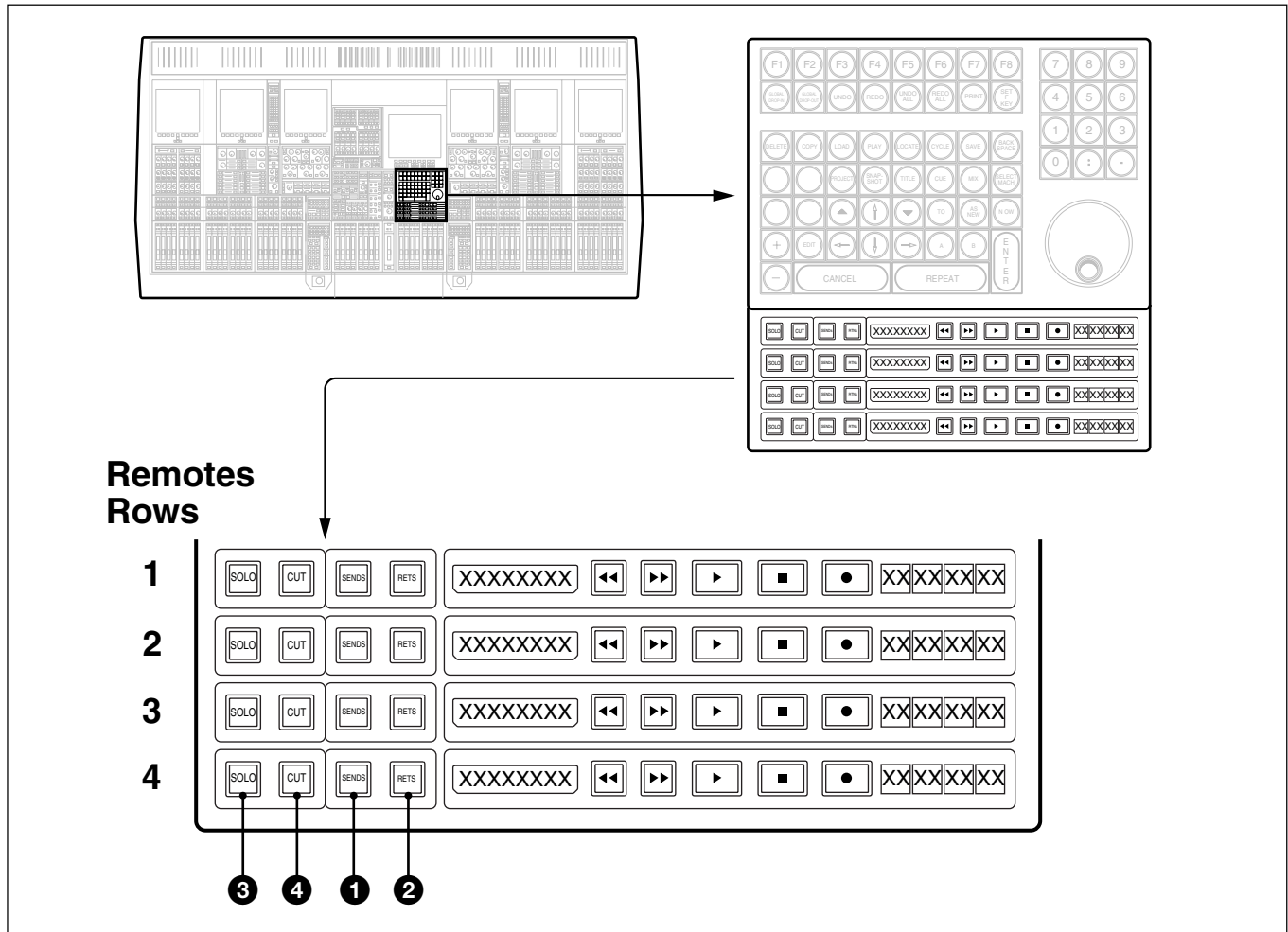

#### STEM monitor switch mapping

The fire-up default sets switch rows on the Control Keyboard to control stems as:

- Remotes Row 1 - Stem A
- Remotes Row 2 - Stem B
- Remotes Row 3 - Stem C
- Remotes Row 4 - Stem D

Mapping is fully flexible via GUI and can include Stems E-H. The GUI set-up operation is described in the following section.



## STEM monitor switch functions

### ❶ SENDS Push-Button(s)

Selects the sources being sent to tape for its stem or stems and inter-cancels with **[RETS]**.

### ❷ RETS (Returns) Push-Button(s)

Selects the return signal from tape for its stem or stems and inter-cancels with **[SENDS]**.

#### Note

*In Multi-Format Mode, the **[SEND]** and **[RET]** buttons for channels assigned as Stem masters also inter-cancel.*

### ❸ SOLO Push-Button(s)

Solos its stem or stems.

### ❹ CUT Push-Button(s)

Cuts its stem or stems.

## Stem monitor switching hierarchy

The monitor switching is controlled top down allowing the flexibility of local overrides at the slave channel level. Pressing either **[SENDS]** or **[RETS]** on the remotes panel in order to change the monitor source will re-synchronise slaves on the first press, if any channels have been overridden locally. A subsequent press will cause the monitor source to change.

The same principle applies to the master buttons in the GUI described in the next section, 4-13-5.

### 4-13-5 Stem Monitor Switching GUI Set-up

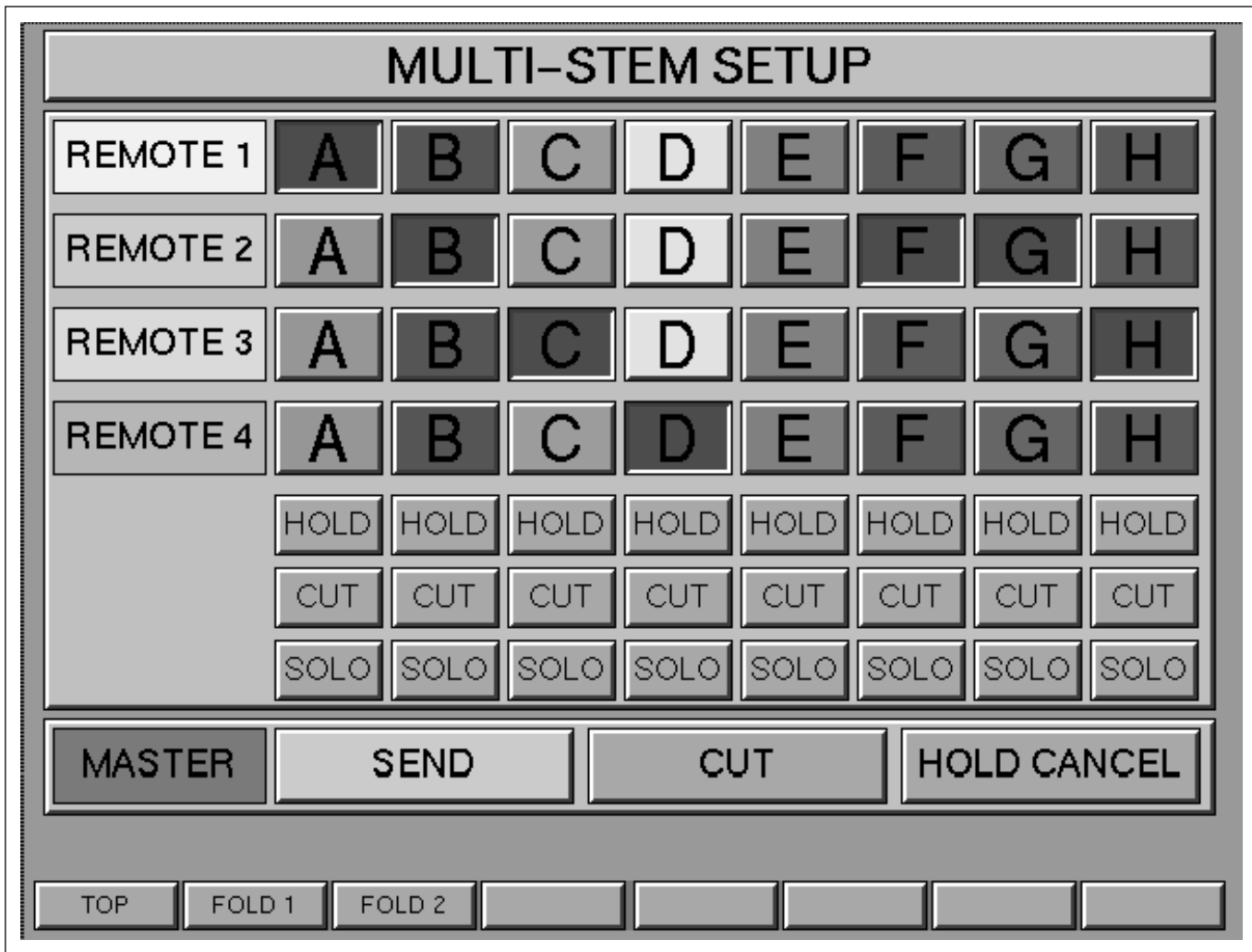

From the OXF-R3 LOGO page, click on M/STEM to view the MULTI-STEM SET-UP GUI.

#### Assigning Stems using the GUI

Any of the Stems A-H which are assigned to the monitor switches in the Remotes Rows will appear in red. Click on them to select or de-select accordingly.

The fire-up default sets switch rows on the Control Keyboard to control stems as:

- REMOTE 1 - Stem A
- REMOTE 2 - Stem B
- REMOTE 3 - Stem C
- REMOTE 4 - Stem D

---

### **HOLD button(s)**

Clicking on and highlighting in red any of the HOLD buttons in the GUI will cause the current monitor selection to be frozen, in that flipping between SENDS and RETS will only affect those not 'held'.

### **CUT button(s)**

Cuts its stem signal.

### **SOLO button(s)**

Solos its stem signal.

## **MASTER Row**

### **SEND button**

Selects the monitor source as the signal being sent to tape for all stems. The button then alternates to RETURN in readiness for selecting the signal returning from tape for all stems.

### **CUT button**

Cuts all stem monitor signals.

### **HOLD CANCEL button**

Cancels any HOLD buttons set on in the GUI.

### **The Softkeys for this GUI:**

- TOP - Selects the top level LOGO screen
- FOLD 1 - Selects FOLD-DOWN MATRIX 7.1 ➔ 5.1 ➔ LCRS
- FOLD 2 - Selects FOLD-DOWN MATRIX 5.1 ➔ STEREO ➔ MONO

4-13-6 Fold-Down Matrix GUIs

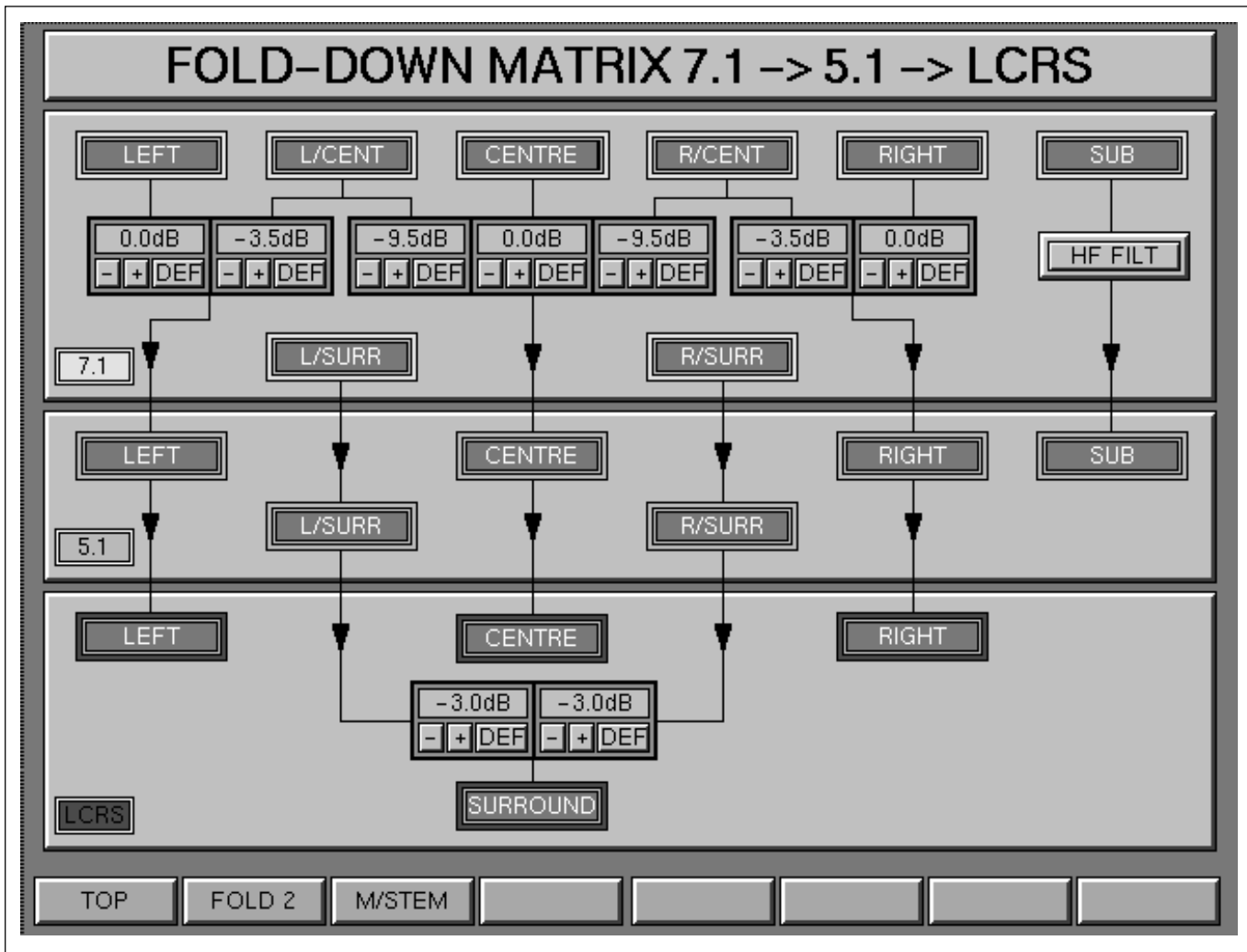

**General**

The two Fold-Down GUIs allow control of the levels for the fold-down of signal sources, when an output is derived from another which has a greater number of outputs. As an example, the Main Output Bus is set up for a 5.1 output and a Stereo Output is required simultaneously, or a Stereo version must be listened to for compatibility checking.

**Operation**

Each Fold-Down destination in the GUIs has a “control module” for each source. For example, when deriving 5.1 from 7.1, the 5.1 LEFT input is being fed from the LEFT and L/CENT of the 7.1 with a level control module for each.

Levels can be set in two ways:

- Click on **DEF** to set the Default values.
- Click on **+** and **-** buttons to set levels manually.

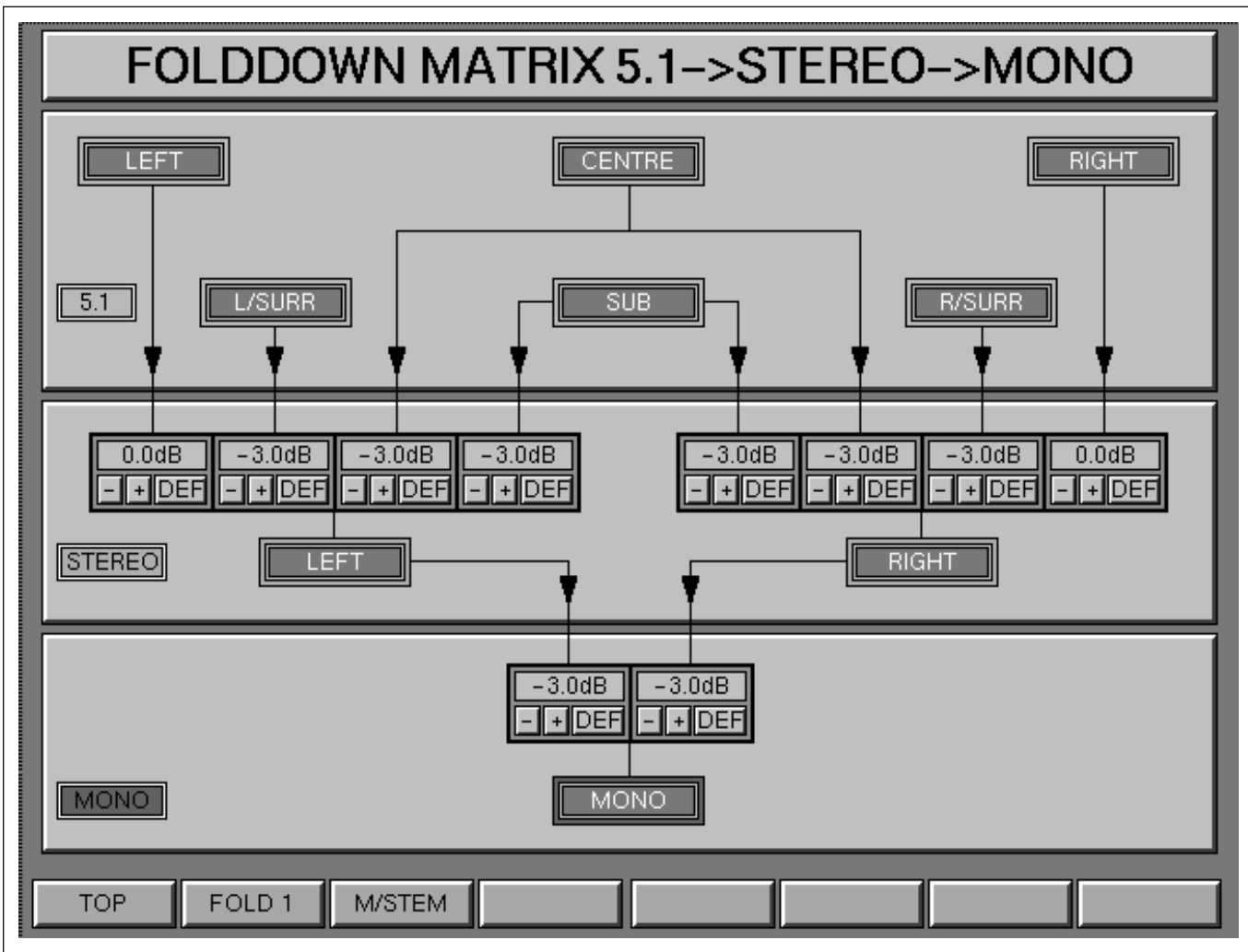

### Defaults

The Defaults are defined in the start-up Config. File settings.

### HF Filter

A low pass filter is available in the Sub channel when folding down from 7.1 to 5.1. Click on **HF FILT**, to the right of the GUI, to insert a filter with a corner frequency of 120Hz and a slope of 24dB/Octave.

### Snapshots

The Fold-Down settings are stored in Snapshots as part of the Centre Section. "CEN" must be selected in the Snapshots GUI in order for these settings to be recalled.

### The Softkeys for these GUIs:

- TOP - Selects the top level LOGO screen
- FOLD # - Alternates between FOLD 1 and FOLD 2
- M/STEM - Selects the MULTI-STEM SET-UP GUI



# Chapter 5 – Control Screens

In this chapter, the user will find a summary of the screens/menus available when operating the OXF-R3 system. They divide into 3 categories: System and general set-up; Session Management™ and those which relate to OXF-R3 mixer functions, such as input and output routing, equaliser and dynamics curve displays. Diagrams are included which show the inter-relationships between the screens available on the central LCD Master Control Screen, referred to as the Session Management™ Screen.

## Chapter 5 Contents

<b>5-1 The Master Control Screens</b> .....	<b>5-2</b>
<b>5-2 Channel Screens</b> .....	<b>5-5</b>
5-2-1 Routing GUI .....	5-8
5-2-2 I/O GUI .....	5-11
5-2-3 Equaliser & Filters GUI .....	5-28
5-2-4 Dynamics GUI .....	5-29
5-2-5 Preferences GUI .....	5-30
5-2-6 Master GUI (includes Main Bus Outputs) .....	5-39

# 5-1 The Master Control Screens

This suite of screen pages is available on the central LCD in the master section. It allows System-related set-up and Session Management™ functions which cover Artists/Projects, Titles, Mixes, Snapshots, Cues and Tracklists. More complex data and mix functions are provided as menu options. Functions involving sub-menus are arranged in a priority system such that the most-used functions are the most readily accessible, where possible. In general, all of the main function screens are accessible from the softkeys located below the screen. Further sub-menus, for more specific operations, are available at subsequent levels below the main menus. At these lower levels, softkey functions allow the return to other main functions without the need to backtrack through multiple levels of the menu hierarchy.

The following diagrams show the inter-relationship of the Session Management™ screen pages and menus available to the operator. The numbers below the softkeys show the screen number (see left-side of diagrams) which is accessed by touching the relevant softkey.

Screen pages available on the centrally-located Session Management™ Screen are shown in Chapters 6 and 7. This chapter illustrates and describes the Channel Screens available on the six LCD Screens, located three on either side of the OXF-R3 centre section.

**Notes:**

- 1 The SHUTDOWN softkey on the System screen page may be used to commence shutdown of the OXF-R3 system.*
- 2 The BACKUPS softkey is available on: the System screen; Artists/Projects & Titles screen; Assemble screen; Offline Automation screen; Global screen and Preferences screen. Select to implement system backup functions.*
- 3 Softkeys shown blank on the Logo screen diagram are not used.*



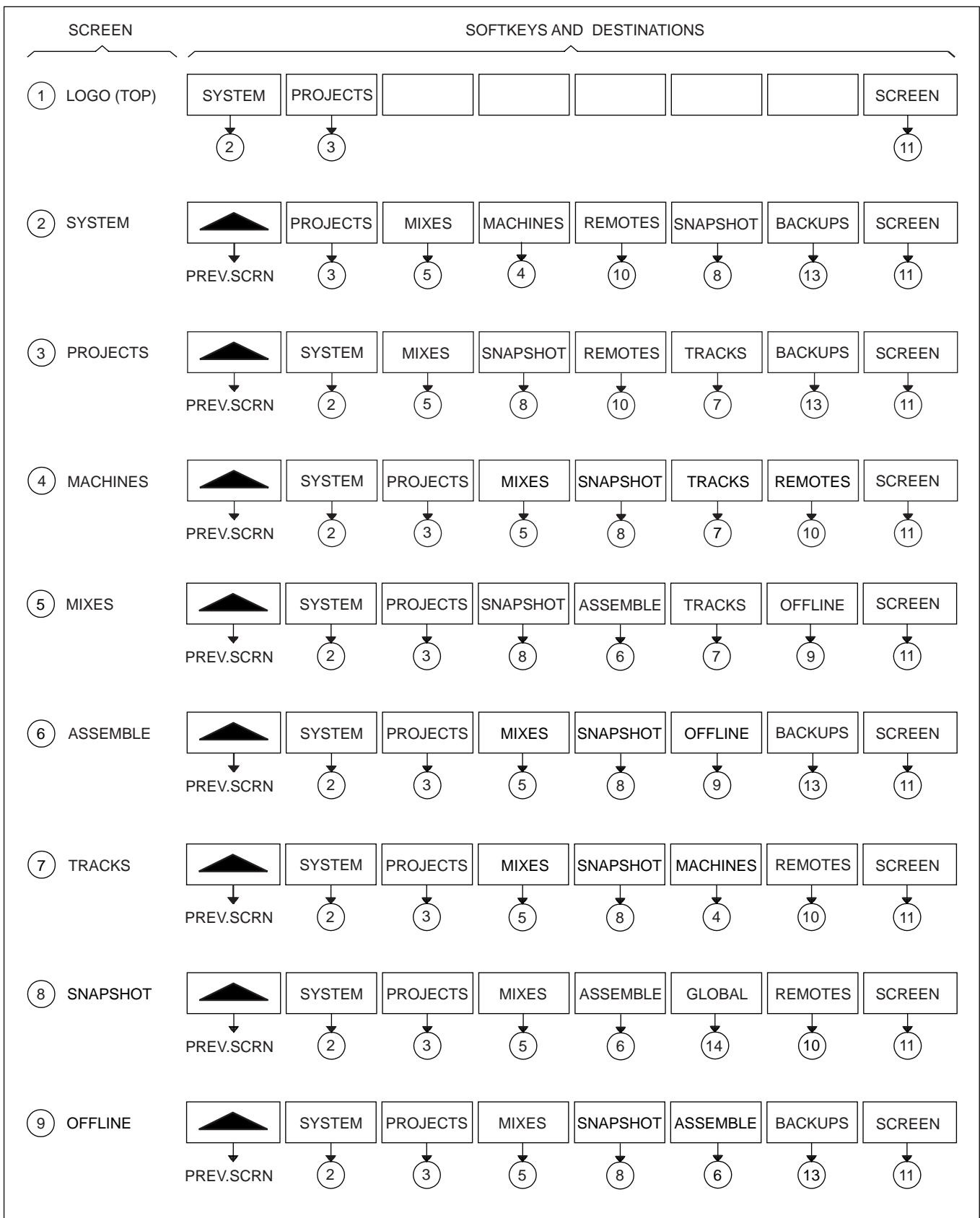

Control Screens structure (1)

# 5-1 The Master Control Screens

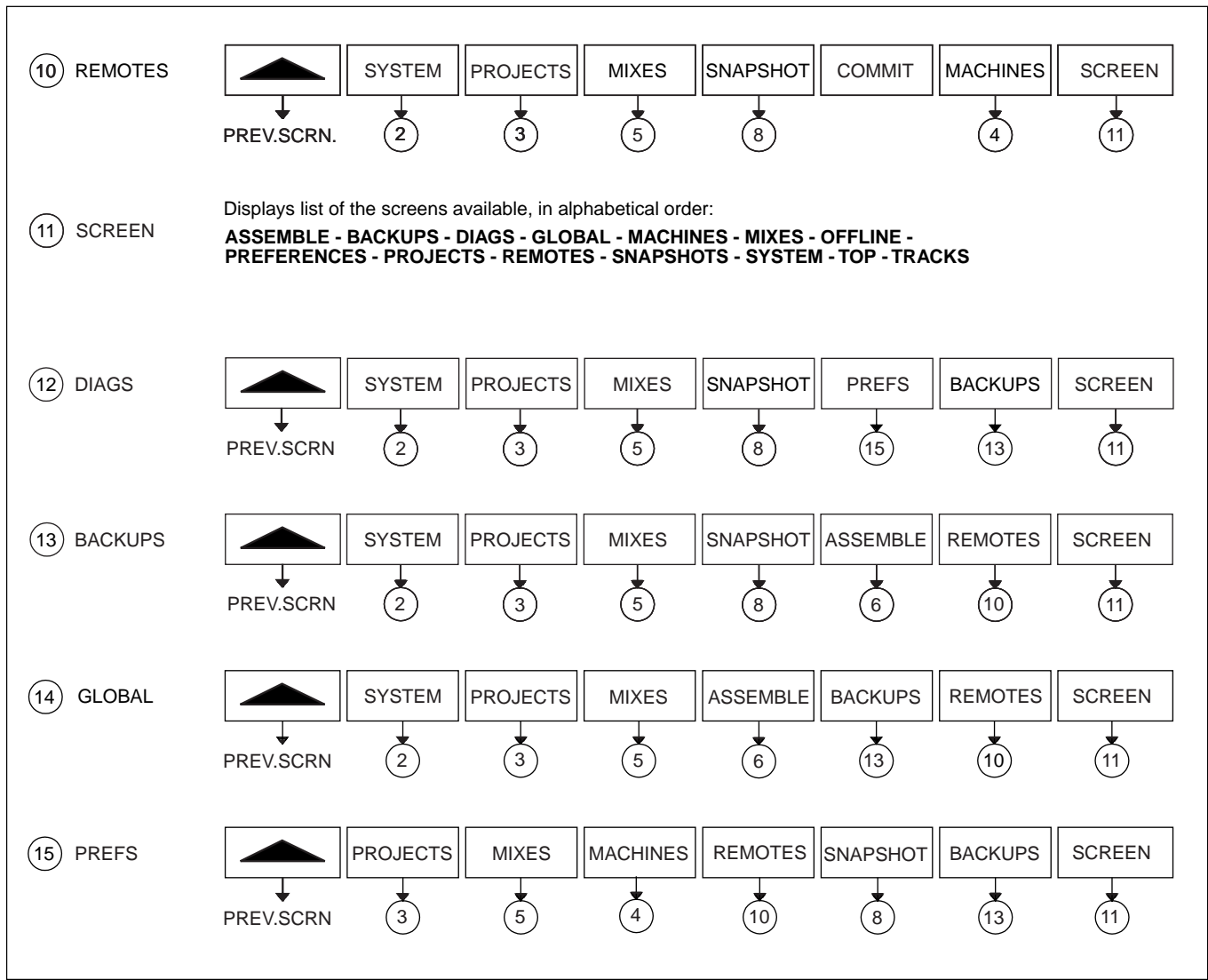

Control Screens structure (2)

## 5-2 Channel Screens

### The Channel Screens in general

Six LCD Channel Screens are provided on the OXF-R3 control surface, three either side of the centre section.

**Note:**

*Each Channel Screen can display any of the functions described. The softkeys below the channel screens give access to other functions. To select these functions, either click on the softkey or press button below the screen.*

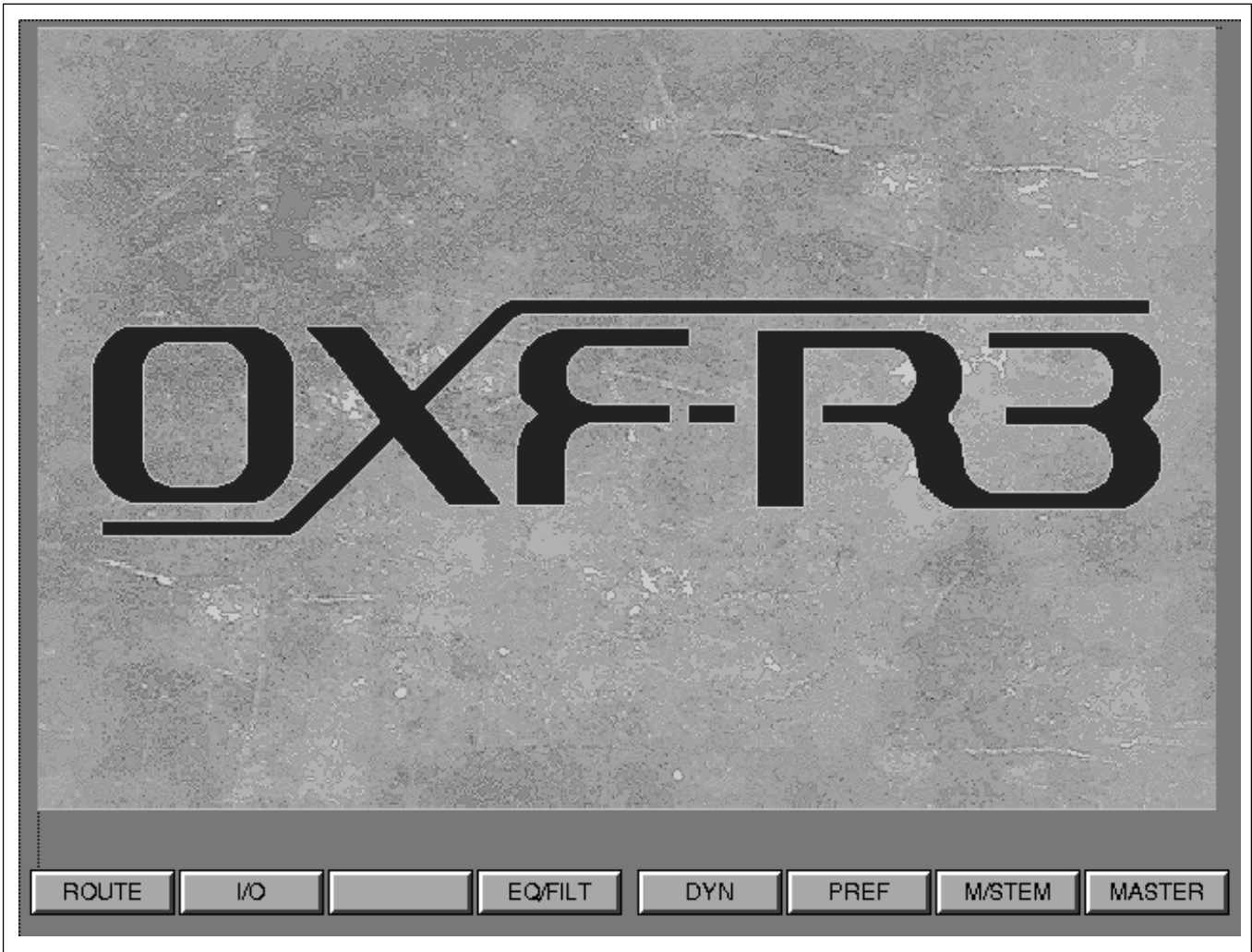

OXF-R3 Logo Screen (TOP)

The OXF-R3 logo screen has softkeys to the other Channel Screens as follows:

- **ROUTE** - Multitrack and Channel Output Routing GUI
- **I/O** - Channel Input & Output Assignments GUI
- **EQ/FILT** - Equaliser and Filters GUI
- **DYN** - Dynamics GUI
- **PREF** - Preferences GUI
- **M/STEM** - Multi-Stem GUI
- **MASTER** - Master Output Assignments GUIs (inc. SSGs & Sends)

To return to this screen at any time, select TOP from any other screen.

## 5-2 Channel Screens

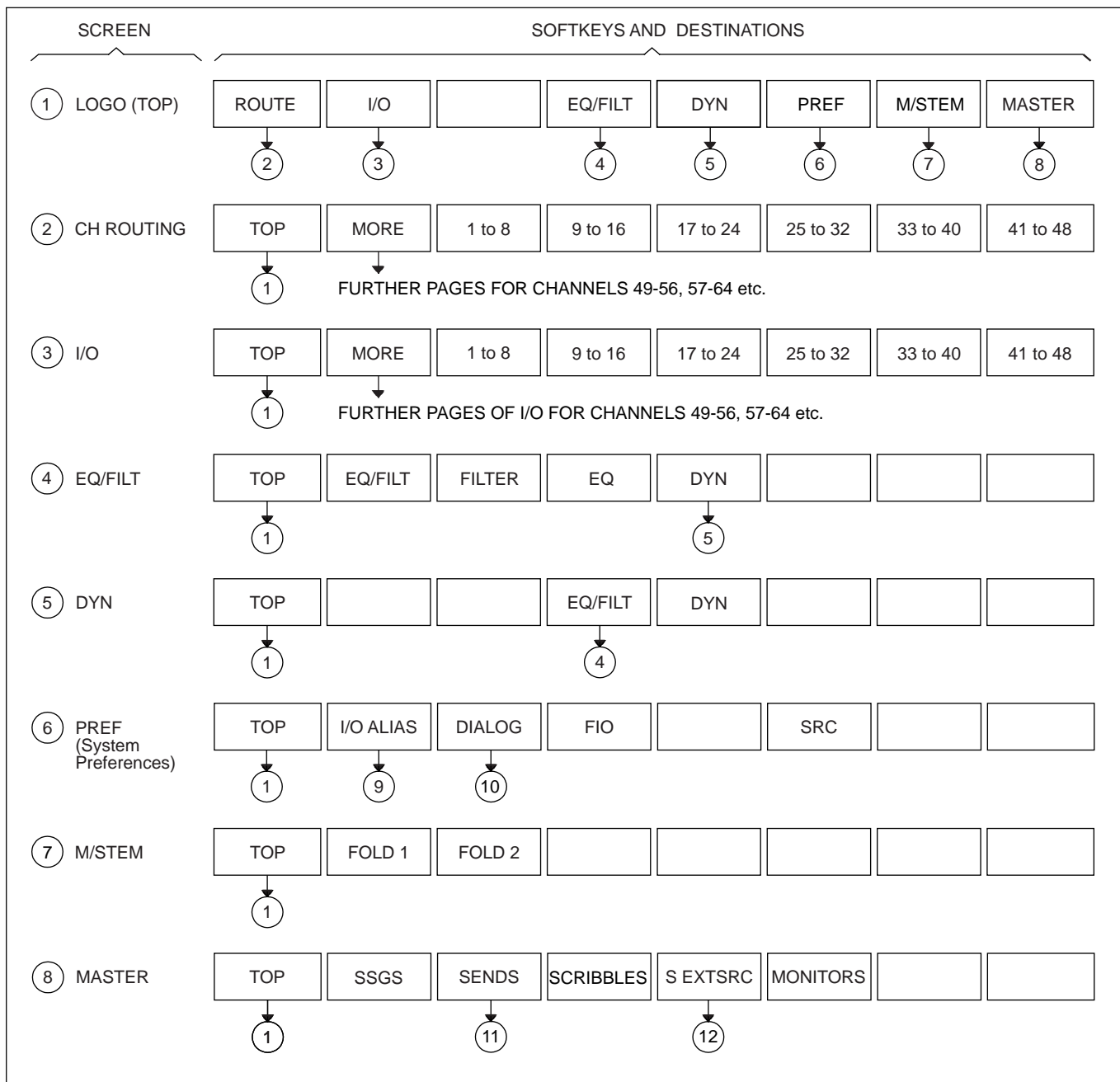

Channel Screens hierarchy, 1st level

All the console input and output assignments can be set and displayed on the channel screens. They include MIC, LINE and M/T Inputs, INSERT Sends and Returns. The MASTER GUI is used to assign all bus outputs, Monitor LS and External Source inputs.

GUIs related to EQ, Filters and Dynamics allow their transfer curves to be displayed.

Preference pages allow 'real' labels, such as MIC 1, to be set for I/O. Each category of I/O has a page that allows custom electronic scribble names to be specified, which appear in the naming pop-ups.

A Fast Insert set-up facility allows I/O (an input and an output) plus a name to be set as a single entity. A single click on that name in the Fast Insert pop-up assigns a send destination, a return source and an electronic scribble name simultaneously.

A Sample Rate Converters (SRCs) set-up GUI allows SRCs be assigned to AES inputs. There is an SRC label local to each digital input/output to indicate the inclusion of an SRC.

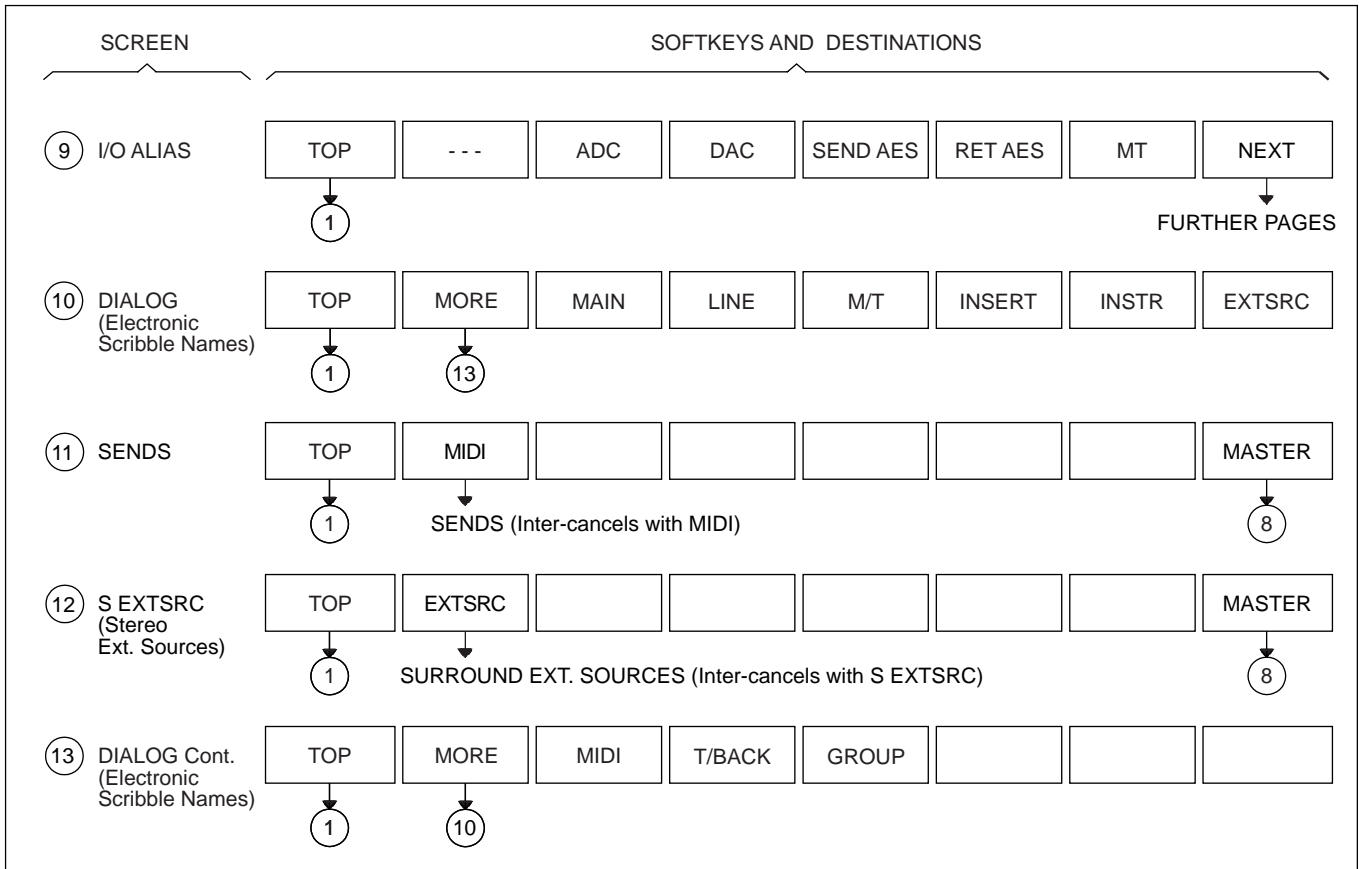

Channel Screens hierarchy, 2nd and 3rd level

**Note:**

Description of the M/STEM GUI (Multi-Stem Set-up) and the two related Fold-Down GUIs are not included in Chapter 5. Please see Chapter 4 for details of these GUIs.

## 5-2 Channel Screens

### 5-2-1 Routing GUI

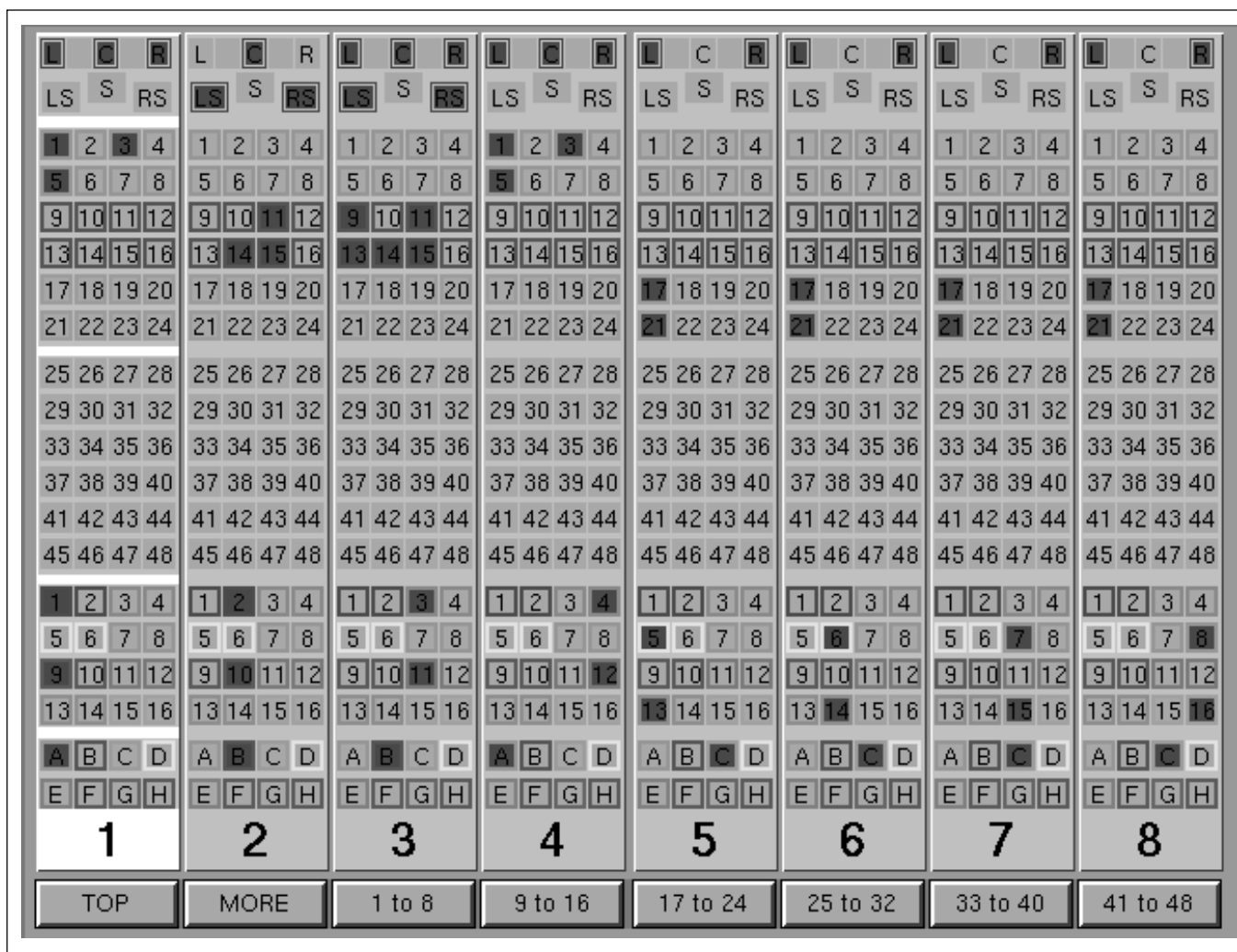

Routing GUI layout

#### General

The Routing GUI displays the channel output routing buttons for 8 channels according to the bank of faders below it, and which faders page is selected on the SELECT TO FADERS panel. For example, if channels 1-24 are selected to the faders and the ROUTING GUI is selected for the middle screen, it will display routing buttons for channels 9-16. There is just one set of actual routing buttons on the ROUTING panel at each side of the control surface, between the second and third screens. Therefore a single channel strip is highlighted to indicate which channel the routing switches are assigned to control. This is set according to the channel currently accessed.

The GUI has been designed to reflect the physical layout of the buttons on the panel. Operations of the real routing switches will be reflected on the screens. Buttons can also be selected via Trackerballs. Press **SELECT** below any GUI in order to set the cursor to the centre of that screen.

Direct the cursor with the Trackerball and press the central red button above the Trackerball to operate button. All routing assignments are indicated by buttons turning red.

To display other groups of 8 channels, click on the appropriate softkey at the bottom of the GUI or push its button below the screen. Select MORE for further groups of channels.

### Upper Surround buttons

The set of 8 buttons at the top of the GUI, set out in a 7.1 LS arrangement, indicate surround routing assignments set by the buttons in the MULTI-FORMAT section of the ROUTING panel. The buttons that are operational at any one time depend on the format set in the centre section (see Chapter 4 for details).

They set assignments for the Main Output Bus or the M/T Busses, depending on which is selected on the SELECT TO FADERS panel. But note that assignments to M/T Busses are possible only if at least one stem has been assigned to the M/T Busses (see Chapter 4 for details).

If  CHANS is lit, the assignments for the Main Output Bus are displayed and changes can be made using the buttons on the ROUTING panel, or using a Trackerball and associated buttons. If  M/T SEND is lit, then these buttons display Stem assignments for the current stem.

### Stem buttons A-H

These buttons, in the lower section of the GUI, inter-cancel and select which stem the 8 buttons in the LS layout are assigned to.

#### Note:

*To avoid routing the same signals to multiple stems, there is an automatic clear option so that when a new stem is selected, assignments for the previous stem are de-assigned. Alternatively they can be cleared manually allowing assignments to multiple stems. See the “STEM CLEARING” option in the section for the PREFERENCES GUI, later in this Chapter.*

### Routing buttons 1-48

These buttons reflect routing assignments to the Multitrack or M/T Busses. Press any button on the ROUTING panel to make an assignment. The output of the M/T Send Fader controls the level. If the M/T Pan is switched in, then the L output feeds odd numbered busses and the R feeds the even.

Stems A-H, which utilise groups of M/T Busses and can be up to 7.1 wide, are set up via the centre section (see Chapter 4 for details). When stems have been set up, the tracks they have been assigned to are distinguished by colour coding of their outside borders. There is a different colour for each stem. They are automatically mapped to the buttons laid out in the form of a set of surround LS at the top of the GUI. So for example, if track 35 is assigned as the Centre track for a stem, just press the  C button and the track 35 button lights too.

Assignments made to tracks which are not set up as part of a stem can be routed as normal, taking the output from the surround panner, L to odd numbered tracks and R to even.

### Super Send Group (SSG) buttons 1-16

These buttons, at the lower part of the GUI, just above the Stem buttons A-H, indicate assignments to the 16 Super Send Groups. The 8 SSG buttons on the ROUTING panel are labelled as , ,  and so on. They operate for SSGs 1-8 or 9-16 depending on whether  or  is selected in the centre section.

Since SSGs may be grouped, they are colour coded in a similar way to the stems with a coloured border around the outside of each button. The fire-up default for SSGs is 8 stereos, but they can also be set up as mono or surround groups. However, note that grouping cannot cross the boundary between the two pages, 1-8 and 9-16.

Super Sends can be set up as:

- **Mono**
- **Stereo**
- **LCR**
- **LCRS**
- **5.0**
- **5.1**
- **7.0**
- **7.1**

The setting up of SSGs is achieved in the centre section. Press and hold the  button for an SSG and wait until it turns amber. Any other SSGs in the same group will light yellow simultaneously. Press  buttons depending on whether more or fewer SSGs are required for that group. De-selecting SSG  buttons must be done from the outer to the inner buttons.

The signal feed to any SSGs has the same pan and level settings as that of the channel output feeding the Main Output Bus.

#### **Note:**

*An SSG can be set up to be wider than the Main Output Bus, e.g. Main could be set for Stereo, whilst an SSG could be 5.1. In this case the surround panning would be fully operational for the SSG whereas the Main Output Bus would receive L/R information only. L/R information includes in-place surround signals.*



## 5-2-2 I/O GUI

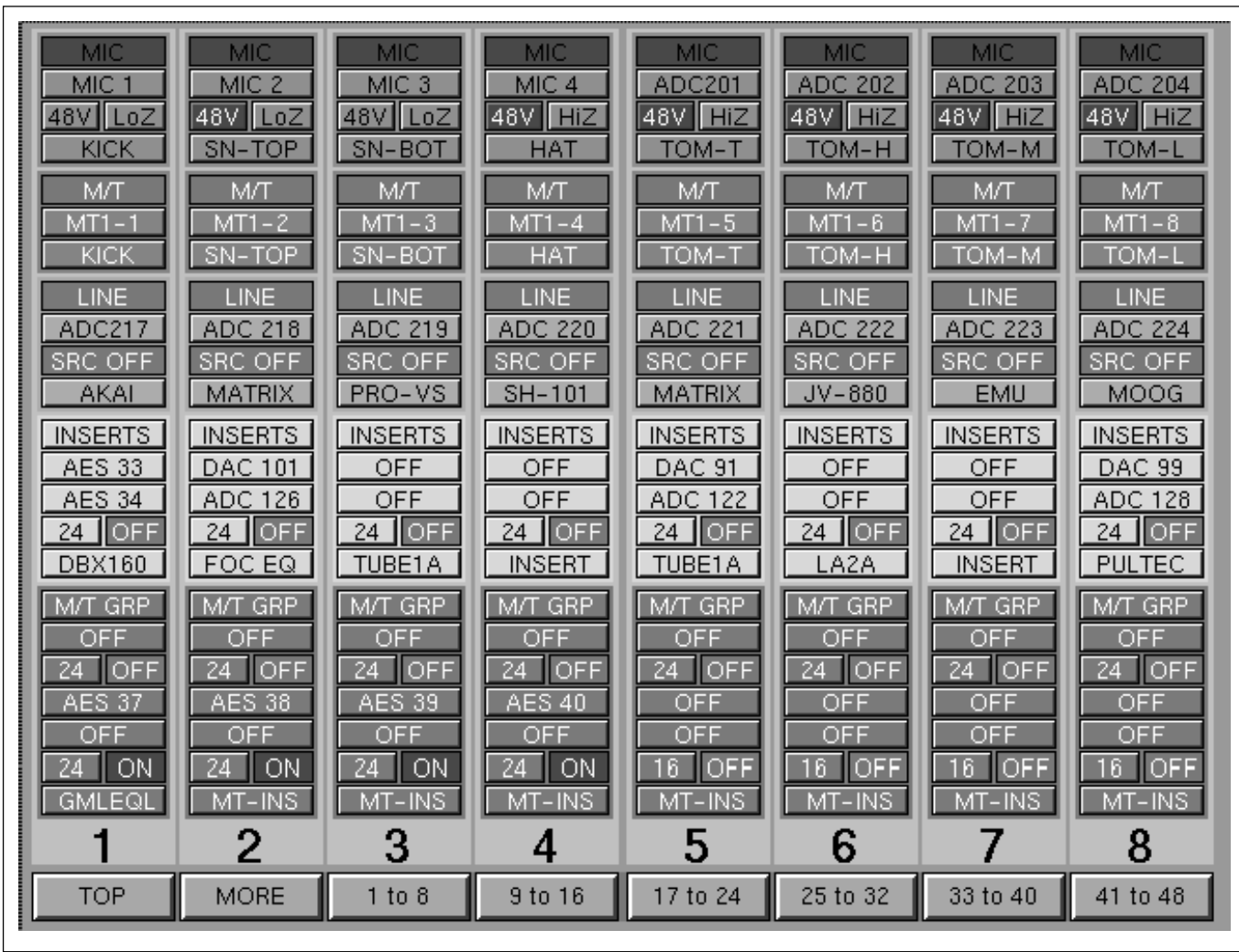

I/O GUI layout

**This GUI allows I/O assignments for:**

- **MONO channels**
- **STEREO Return channels**

The I/O GUI Screen contains dialogue blocks for the following I/O:

- **Mic Inputs**
- **Line Inputs**
- **Multitrack Inputs**
- **Channel Inserts**
- **Multitrack Group Send Outputs and Inserts**

Softkeys 3-8 may be used to select other groups of channels i.e. the first screen gives immediate access to channels 1-48. For further pages of channel groups, select the softkey MORE.



### Indication of inputs and outputs already in use

The I/O is assigned using the GUIs illustrated on the following pages. Various pop-ups are used to display sources and destinations. Objects already in use will be indicated by [xxx]. For example if ADC10 is in use it will be indicated as [ADC10].

### Printing GUI pages

All GUIs displayed on the channel LCDs can be printed, one at a time, using the following procedure:

- Select the PREF page on one of the LCDs. It does not have to be the LCD displaying the GUI to be printed and often it is more convenient to use another.
- Click on PRINT in the box lowest right.
- Move the cursor into the screen to be printed if it is not already there. This can be done with a Trackerball or by pressing the SELECT button below the LCD just once.
- Once the cursor is displayed on the screen to be printed, press the SELECT button below the LCD to print the image.
- This is a one-shot operation and once the printing has been actioned the PRINT option in the PREF page reverts to SELECT.
- Click on PRINT once more to print a second or further GUI image.

**Note:**

*This print output function requires the system to be configured with a Postscript compatible printer.*

## 5-2 Channel Screens

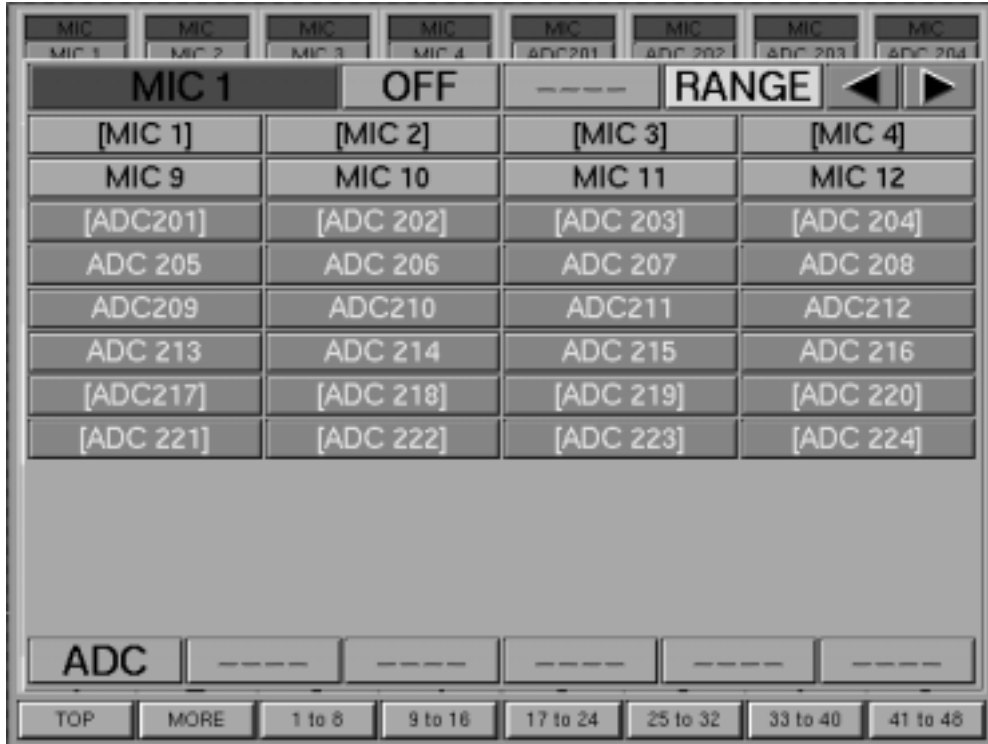

Figure A

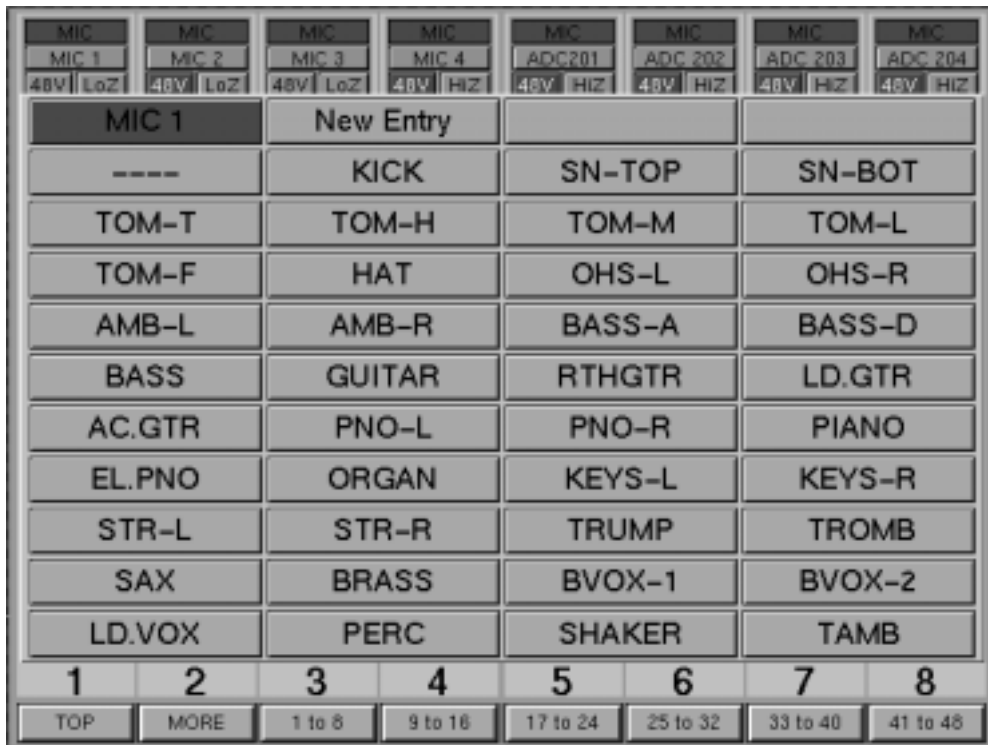

Figure B

MIC INPUT pop-ups

## Assigning MIC INPUTS

The upper 8 blocks in the GUI entitled MIC, each with 3 clickable fields below, are used for setting up MIC inputs.

### INPUT – Upper field

The upper field is used to select the ADC. Click on this field to display a pop-up dialogue box as shown in Figure A. The channel number is displayed in the pop-up according to the channel selected. If OFF is selected, there will be no source. Click on the required ADC number or name alias to connect that input to the selected channel.

### RANGE

A contiguous range of inputs can be assigned simultaneously. To assign a set of consecutive inputs to a number of consecutive channel inputs, ADCs 9-16 to channel Mic Inputs 1-8 as an example:

- Click on the upper field below the MIC legend of Channel 1 for the assignment pop-up shown in Figure A.
- Click on RANGE and its characters turn white and the background red.
- Click on the lowest number of the ADCs required, 9 in this example, and it highlights red.
- Click on the highest number of the ADCs required, 16 in this example, and ADCs 9-16 are assigned simultaneously to Mic Inputs 1-8.

#### Note:

*ADCs already in use will be “stolen” in all cases when the RANGE function is used.*

To set a range of inputs to off:

- Click on RANGE and its characters turn white and the background red.
- Click on OFF for a pop-up displaying the channel numbers.
- Click on the first and last of the range required.

### PHANTOM POWER – Second field left

The second field (left) toggles between 48V ON and 48V OFF, for phantom powering microphones.

### INPUT IMPEDANCE – Second field right

The second field (right) allows the user to toggle between a HIGH Z and LOW Z, high or low impedance, for the microphone input.

### NAME – Third field

The third (lowest) field is used to enter an electronic scribble name for the MIC INPUT. Click on this to display a pop-up as shown in Figure B. Either click on a name in the list or click on NEW ENTRY and use the QWERTY keyboard to type in a new name of up to 6 characters. Press ENTER when finished.

## 5-2 Channel Screens

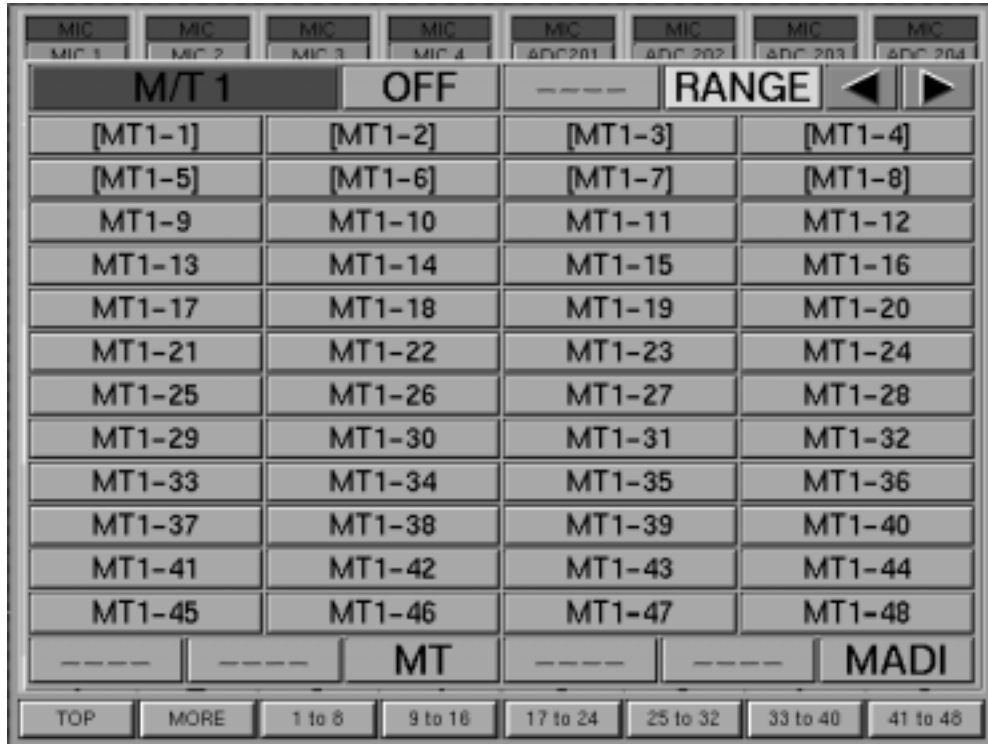

Figure A

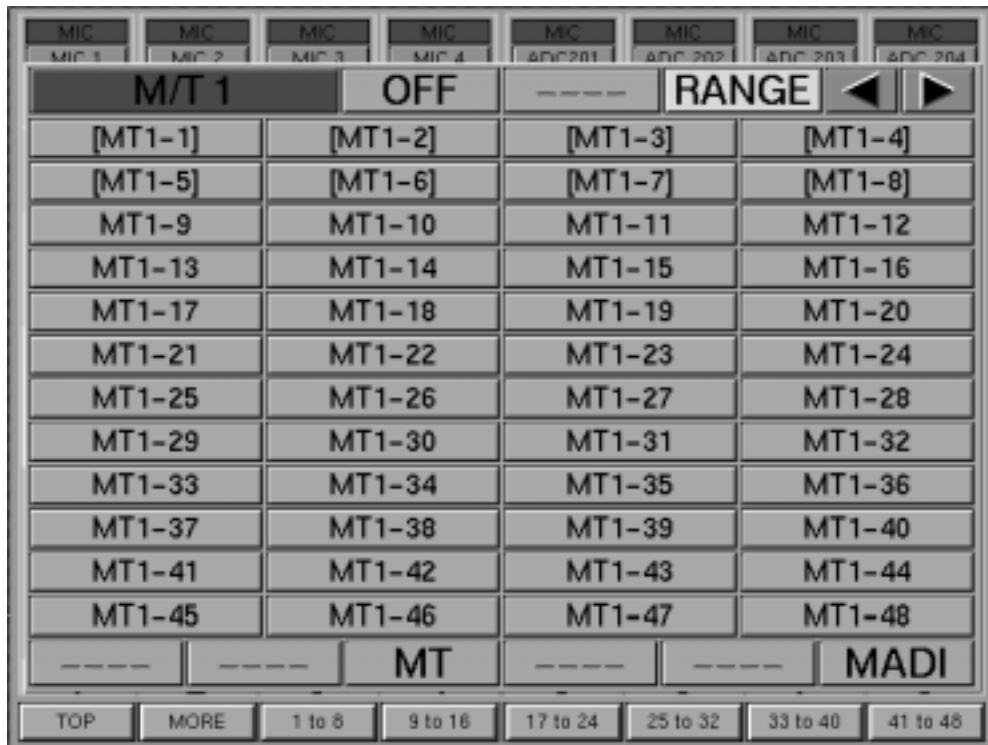

Figure B

M/T RETURN INPUTS GUI pop-ups

## Assigning M/T INPUTS

The second 8 blocks entitled M/T, each with 2 clickable fields below, are used for setting up the multitrack inputs.

### INPUT – Upper field

The upper field of each block is used to select the input source. Click on this to display a pop-up of the available sources as in Figure A. Click on the desired source to select it. The sources available include multitrack channels 1-48 and MADi signals 49-56.

### RANGE

A contiguous range of inputs can be assigned simultaneously. To assign a set of consecutive inputs to a number of consecutive channel inputs, M/T Returns 1-48 to channel M/T Inputs 1-48 as an example:

- Click on the upper field below the M/T legend of Channel 1 for the assignment pop-up shown in Figure A.
- Click on RANGE and its characters turn white and the background red.
- Click on the lowest number of the M/T Returns required, 1 in this example, and it highlights red.
- Click on the highest number of the M/T Returns required, 48 in this example, and M/T Returns 1-48 are assigned simultaneously to Channels 1-48.

#### Note:

*M/T Returns already in use will be “stolen” in all cases when the RANGE function is used.*

To set a range of inputs to off:

- Click on RANGE and its characters turn white and the background red.
- Click on OFF for a pop-up displaying the channel numbers.
- Click on the first and last of the range required.

### NAME – Lower field

The lower field is used to enter an electronic scribble name. Click on this to display a pop-up as shown in Figure B. Either click on a name in the list or click on NEW ENTRY and use the QWERTY keyboard to type in a new name of up to 6 characters. Press ENTER when finished.

Click on ‘Track List’ at the top of the pop-up to load the name in the Track List for Multitrack machines MT1 or MT2 in the Session Manager™. These names are assigned using the central LCD. Click “All Tracks” to load all the names for MT1 or MT2.

#### Note:

*These options are available only if one or more outputs from MT1 or MT2 are actually assigned to inputs on the M/T INPUTS GUI. It is possible to load Track List names directly from the TRACK LISTS GUI. This is described in Chapter 7.*

## 5-2 Channel Screens

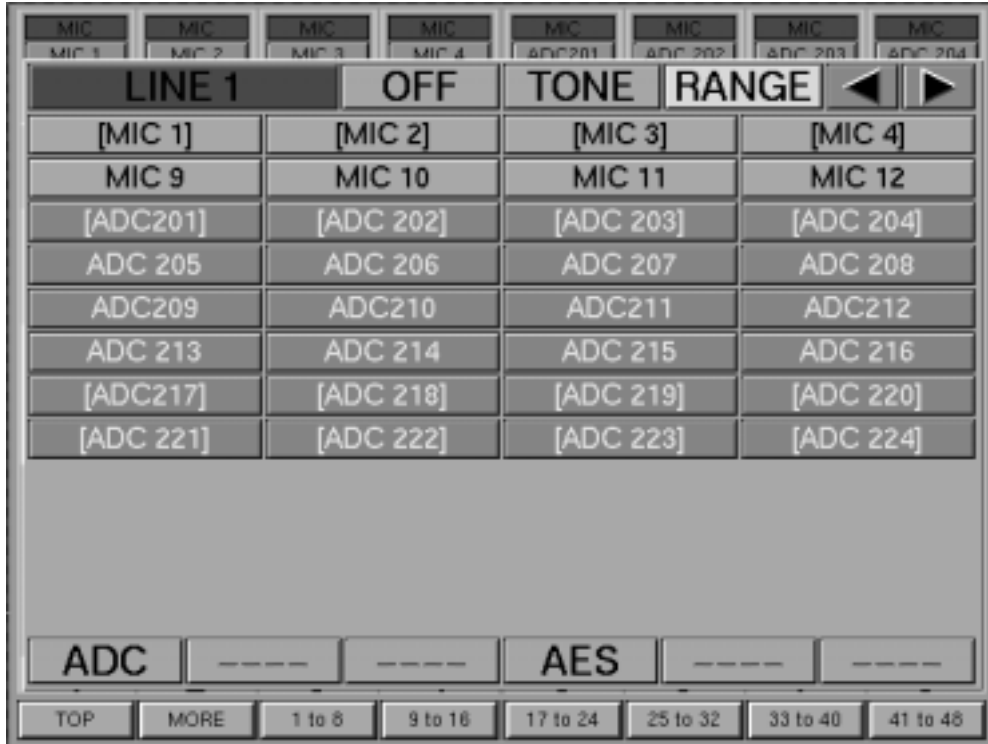

Figure A

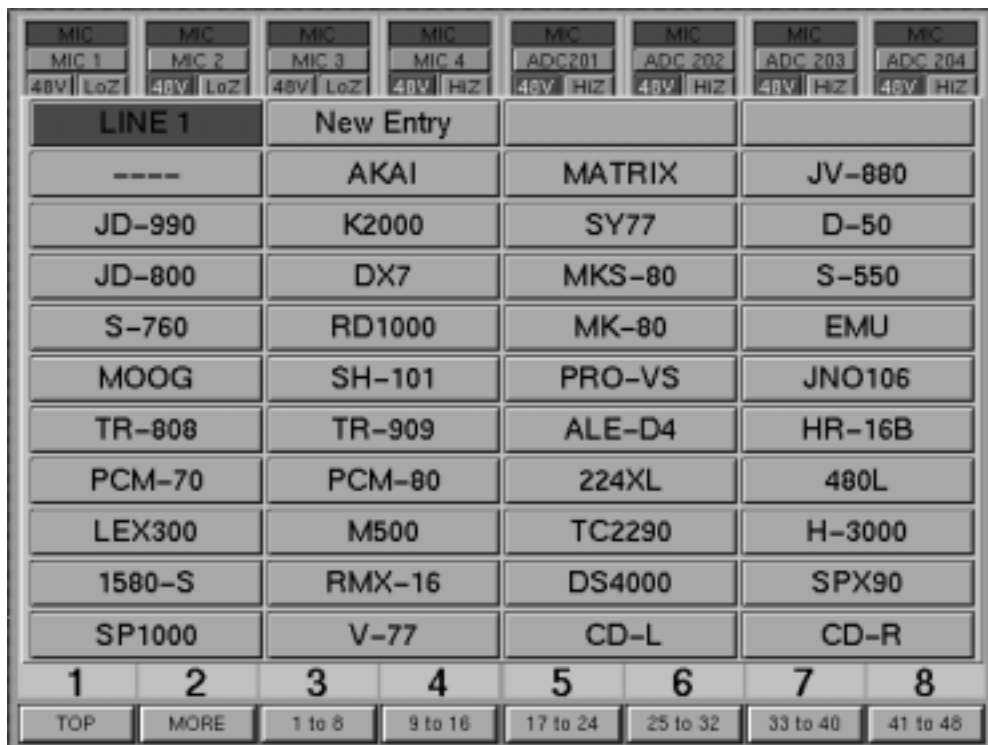

Figure B

LINE INPUTS pop-ups



## Assigning LINE INPUTS

The middle 8 blocks entitled LINE, each with 2 clickable fields and an indicator below, are used for setting up LINE inputs.

### INPUT – Upper field

The upper field is used to select the I/O source. Click on this to display a pop-up as in Figure A.

If OFF is selected, there will be no input source. If TONE is selected, the source is the oscillator as set up in the console centre section.

To select a source, click on one in the list. These can be ADC (analogue) sources or AES (digital) sources, as numbered. Clicking on AES will swap from the ADC page (Figure A) to the AES page and vice versa.

### RANGE

A contiguous range of inputs can be assigned simultaneously. To assign a set of consecutive inputs to a number of consecutive channel inputs, ADCs 17-24 to channel Line Inputs 1-8 as an example:

- Click on the upper field below the LINE legend of Channel 1 for the assignment pop-up shown in Figure A.
- Click on RANGE and its characters turn white and the background red.
- Click on the lowest number of the ADCs required, 17 in this example, and it highlights red.
- Click on the highest number of the ADCs required, 24 in this example, and ADCs 17-24 are assigned simultaneously to Line Inputs 1-8.

#### Note:

*ADCs already in use will be “stolen” in all cases when the RANGE function is used.*

To set a range of inputs to off or assign the oscillator signal set at the master section:

- Click on RANGE and its characters turn white and the background red.
- Click on OFF or TONE for a pop-up displaying the channel numbers.
- Click on the first and last of the range required.

### SAMPLE RATE CONVERTER – Second field (Indicator)

This indicator turns red and reads “SRC ON” when a digital source is selected which has its SRC turned on. SRCs are controlled via the PREFERENCES GUI, described later in this chapter.

### NAME – Third field

The lower field is used to enter an electronic scribble name for the LINE INPUT. Click on this to display a pop-up as shown in Figure B. Either click on a name already displayed or click on NEW ENTRY and use the QWERTY keyboard to type in a new name of up to 6 characters. Press ENTER when finished.

## 5-2 Channel Screens



CHANNEL FAST INSERTS pop-up

### Assigning CHANNEL INSERTS

The 8 blocks towards the bottom of the GUI entitled INSERTS, each with 5 fields (the title is a useable field too), are used to set up channel inserts. Inserts can be set up in two ways, using the pre-assigned FAST INSERTS via the upper field or by setting each item individually using the other fields.

#### FAST INSERT – Upper field

Clicking on the upper INSERTS field gives access to the FAST INSERTS pop-up. Each selection can have a pre-assigned input, output and appropriate name. These are set up via the PREF (Preferences) GUI described later in this chapter.

Click on the desired device name in the pop-up and its input and output will be connected simultaneously. The I/O device names will be displayed in the second and third fields and the actual device name will be displayed in the fifth scribble field. Selecting INSERT at the INPUT CHANNEL & INSERTS panel will display the device name in the dot character display.

Once actioned as a Fast Insert, the assignments to the other fields can be edited or set up on an individual basis as follows:

#### INSERT SEND – Second field

The second field is used to specify an I/O destination for the selected channel Insert Send. Click on this for the pop-up displaying possible

destinations. Figure A shows analogue destinations (DACs). Click on the desired DAC number to assign a Send. For a digital output, click on AES for the list of digital destinations. Further pages of related pop-ups can be accessed by clicking on ◀ or ▶. Click on OFF to disable a Send.

### **RANGE**

A contiguous range of Insert Sends can be assigned simultaneously. To assign a set of consecutive Insert Sends to a number of consecutive outputs, channel Insert Sends 1-4 feeding DACs 5-8 as an example:

- Click on the field below the INSERTS button of Channel 1 for the assignment pop-up shown in Figure A.
- Click on RANGE and its characters turn white.
- Click on the lowest number of the DACs required, 5 in this example, and it highlights red.
- Click on the highest number of the DACs required, 8 in this example, and DACs 5-8 are assigned simultaneously to channel Insert Sends 1-4.

#### **Note:**

*DACs already in use will be “stolen” in all cases when the RANGE function is used.*

To set a range of inputs to off:

- Click on RANGE and its characters turn white and the background red.
- Click on OFF for a pop-up displaying the channel numbers.
- Click on the first and last of the range required.

### **INSERT RETURN – Third field**

The third field is used to select the I/O Insert Return source for the channel. Click on this to display a pop-up similar to that shown in Figure B. Click on the desired analogue return source or click on AES for the digital return sources. Other functions related to the Return operate in exactly the same way as for the Insert Sends.

### **RANGE**

The Range function works for Insert Returns in the same way as it does for Insert Sends.

### **WORD LENGTH – Fourth field left**

The fourth field allows the channel Insert Send word length to be set, if the send is digital. Click on it to cycle through the word lengths 16 bit, 20 bit and 24 bits.

### **SAMPLE RATE CONVERTER – Fourth field right (Indicator)**

This indicator turns red and reads “ON” when a digital I/O is selected which has an SRC turned on. SRCs are controlled via the PREFERENCES GUI, described later in this chapter.

## 5-2 Channel Screens

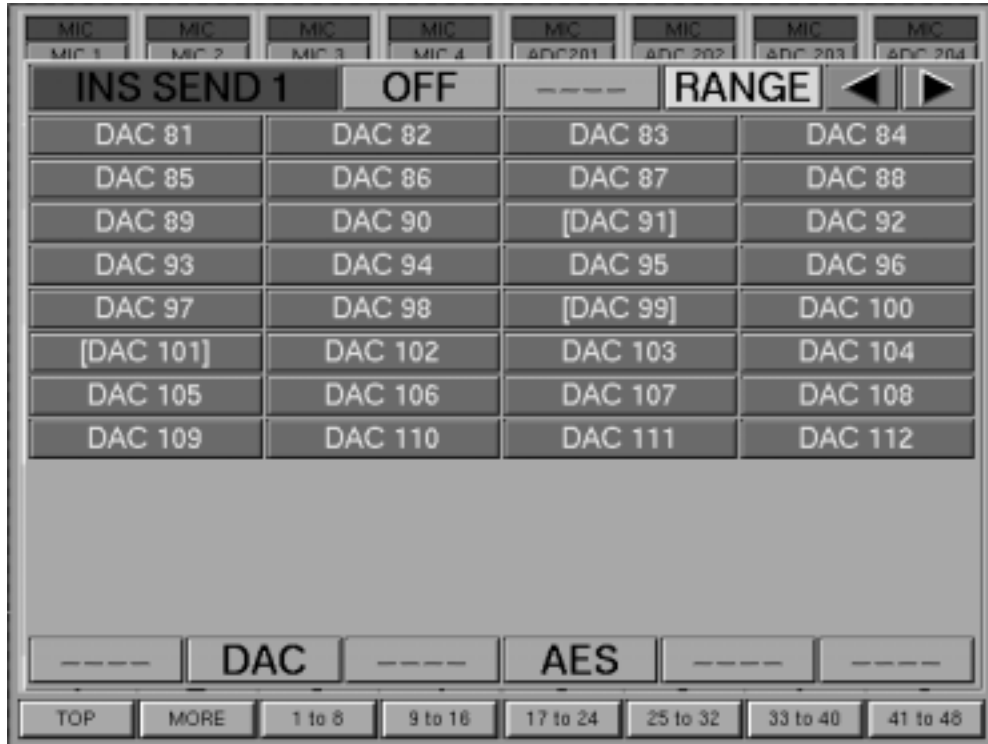

Figure A

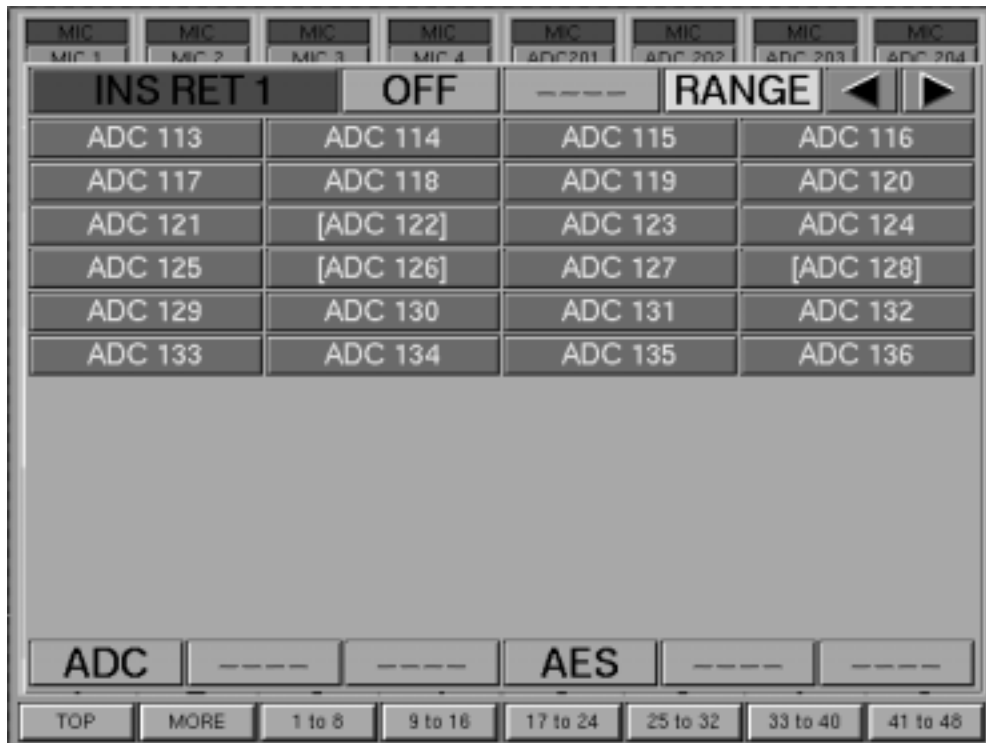

Figure B

CHANNEL INSERT pop-ups

MIC	MIC	MIC	MIC	MIC	MIC	MIC	MIC
MIC 1	MIC 2	MIC 3	MIC 4	ADC201	ADC 202	ADC 203	ADC 204
48V LoZ	48V LoZ	48V LoZ	48V HiZ	48V HiZ	48V HiZ	48V HiZ	48V HiZ
<b>INS 1</b>	New Entry						
INSERT	MT-INS	1960	1961				
DBX160	DBX165	DBX166	DBX902				
DBX120	PULTEC	SONYF7	TTCOMP				
APHEXL	APHEXR	GMLEQL	GMLEQR				
TUBE1A	TUBE1B	DS201L	DS201R				
BS402L	BS402R	BS502L	BS502R				
BS901	A&D760	DL221	FRCHLD				
KT 60	KT 360	SUMTLA	SUM EQ				
1176 1	1176 2	DRM500	ORB EQ				
LA2A	KEPEX2	db 740	FOC EQ				
<b>1</b>	<b>2</b>	<b>3</b>	<b>4</b>	<b>5</b>	<b>6</b>	<b>7</b>	<b>8</b>
TOP	MORE	1 to 8	9 to 16	17 to 24	25 to 32	33 to 40	41 to 48

Figure C

CHANNEL INSERT pop-up

**NAME – Fifth field**

Click on the fifth (lowest) field to name the device inserted. This name appears in an 8-character display in the Input Channel & Inserts panel when the Insert function is selected. A pop-up appears as in Figure C. Click on a suitable name already in the list or select NEW ENTRY and use the QWERTY keyboard to type in a new name of up to 8 characters. Press ENTER when finished.

## 5-2 Channel Screens



Figure A - M/T GROUP FAST INSERT

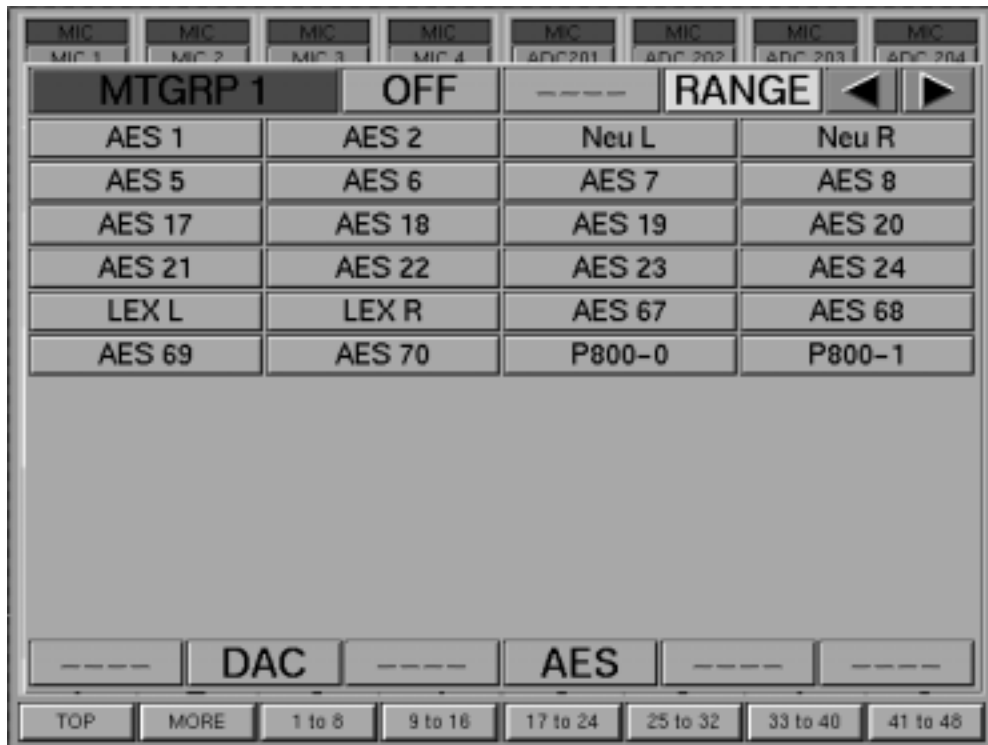

Figure B - M/T GROUP OUTPUT

M/T GROUP pop-ups

## Assigning M/T GROUP INSERTS and OUTPUTS

The 8 blocks at the bottom of the GUI entitled M/T GRP, each with 7 clickable fields (including the title) are used to set up the multitrack outputs and inserts.

### FAST INSERT – Upper field

Clicking on the upper M/T GRP field gives access to the FAST INSERTS pop-up. Each selection can have a pre-assigned input, output and appropriate name. These are set up via the PREF (Preferences) GUI described later in this chapter.

Click on the desired device name in the pop-up and its input and output will be connected simultaneously. The I/O device names will be displayed in the fourth and fifth fields and the actual device name will be displayed in the seventh (lowest) scribble field. The name will also be displayed in the Insert section of the MULTITRACK Panel in the dot character display.

Once actioned as a Fast Insert, the assignments to the other fields can be edited or set up on an individual basis as described later.

#### Note:

*The M/T GROUP OUTPUTS are always fed to MADI loops 1 and 2 but further parallel assignments can be made as follows:*

### GROUP OUTPUT – Second field

The second field is used to select the destination for the M/T Group outputs. Click on this for the pop-up displaying possible destinations. Figure A shows analogue destinations (DACs). Click on the desired DAC number to assign a Send. For a digital output, click on AES for the list of digital destinations. Further pages of related pop-ups can be accessed by clicking on ◀ or ▶. Click on OFF to disable an output.

### RANGE

A contiguous range of M/T Group outputs can be assigned simultaneously. To assign a set of consecutive groups to a number of consecutive outputs, channel M/T Groups 1-4 feeding DACs 5-8 as an example:

- Click on the second field of Channel 1 for the assignment pop-up shown in Figure B.
- Click on RANGE and its characters turn white and the background red.
- Click on the lowest number of the DACs required, 5 in this example, and it highlights red.
- Click on the highest number of the DACs required, 8 in this example, and DACs 5-8 are assigned simultaneously to M/T Group Sends 1-4.

### GROUP O/P WORD LENGTH – Third field left

The third field allows the M/T Group output word length to be set, if the send is digital. Click on it to cycle through the word lengths 16 bit, 20 bit and 24 bits.

#### Note:

*The word length for the MADI output is set at the central Monitor Panel.*

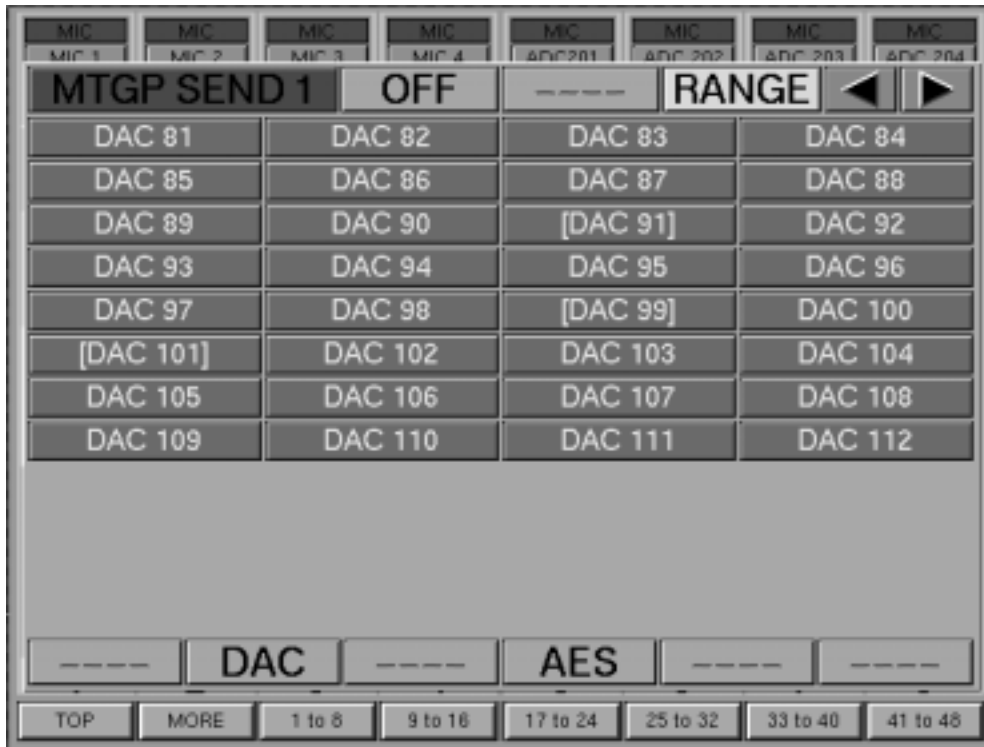

Figure C - INSERT SEND

M/T GROUP pop-up

### GROUP O/P SAMPLE RATE CONVERTER – Third field right

This indicator turns red and reads “ON” when a digital I/O that has an SRC turned on is selected. SRCs are controlled via the PREFERENCES GUI, described later in this chapter.

### INSERT SEND – Fourth field

The fourth field is used to select the M/T Group insert send destination or adjust an assignment set using the Fast Insert function. Click on this to display a pop-up as shown in Figure C. Click on the desired analogue send destination or click on AES for the digital send destination. Further pages of related pop-ups can be accessed by clicking on ◀ or ▶. Click on OFF to disable an insert send. Click on RANGE to set a contiguous set of M/T Group Insert Sends as described for the second field in this section.

### INSERT RETURN – Fifth field

The fifth field is used to select the M/T Group insert returns. Click on this to display a pop-up. Click on the desired analogue return source or range.

### WORD LENGTH – Sixth field left

The sixth field (left) allows the M/T Group insert send and return word length to be set, if the insert device is digital. Click on it to cycle through the word lengths 16 bit, 20 bit and 24 bits. It will be set for both send and return simultaneously.



---

**INSERT SAMPLE RATE CONVERTER – Sixth field right**

This indicator turns red and reads “ON” when a digital I/O that has an SRC turned on is selected. SRCs are controlled via the PREFERENCES GUI, described later in this chapter.

**NAME – Seventh field**

The seventh (lowest) field is used to enter an electronic scribble name for the insert. Click on this to display a pop-up. Either click on a name already in the list or select NEW ENTRY and use the QWERTY keyboard to type in a new name of up to 8 characters. Press ENTER when finished.



### 5-2-3 Equaliser & Filters GUI

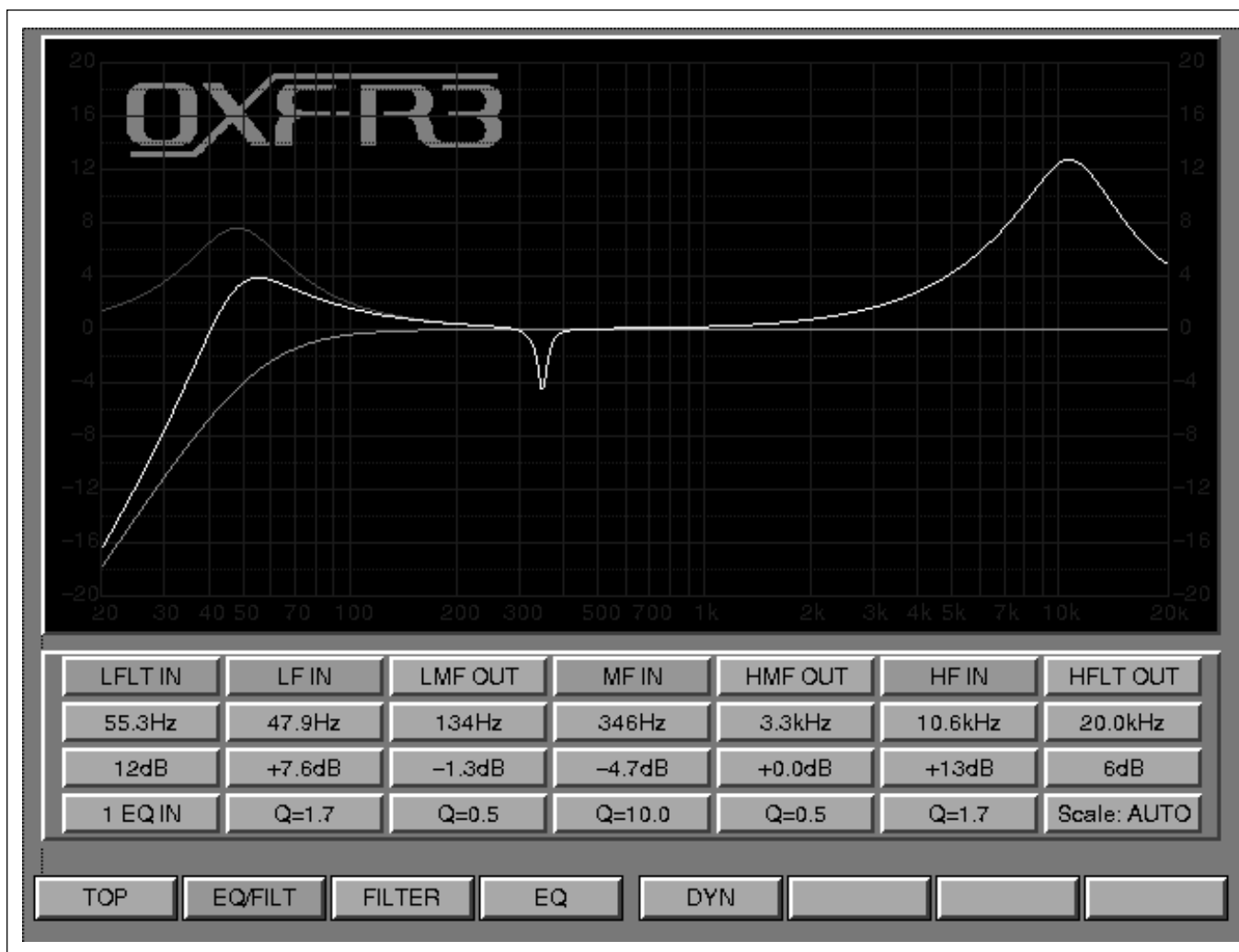

EQUALISER & FILTERS GUI layout

This GUI displays the 5 Band Equaliser, High and Low Filter curves as a combination (default) or individually. The parameters for each section are also indicated.

#### Viewing EQ and Filter curves (Press softkeys below the LCD screen)

- **EQ/FILT** - The combination of EQ and Filters is displayed in White.  
- Red line = EQ contribution; Green = Filters contribution.
- **FILTER** - Combined HF and LF Filters response curve only.
- **EQ** - Equaliser response curve only.

To view the individual contribution of any particular band, click on its name field e.g. MF IN. The colour coded individual curve will be displayed along with the combined response. Click **EQ** to release.

The vertical scale for boost and cut can be set using the ▲ and ▼ keys below the screen. The scale options are: +/-2.5dB, +/-5dB, +/-10dB, +/-15dB, +/-20dB, +/-40dB, +/-100dB and AUTO which is the default.

## 5-2-4 Dynamics GUI

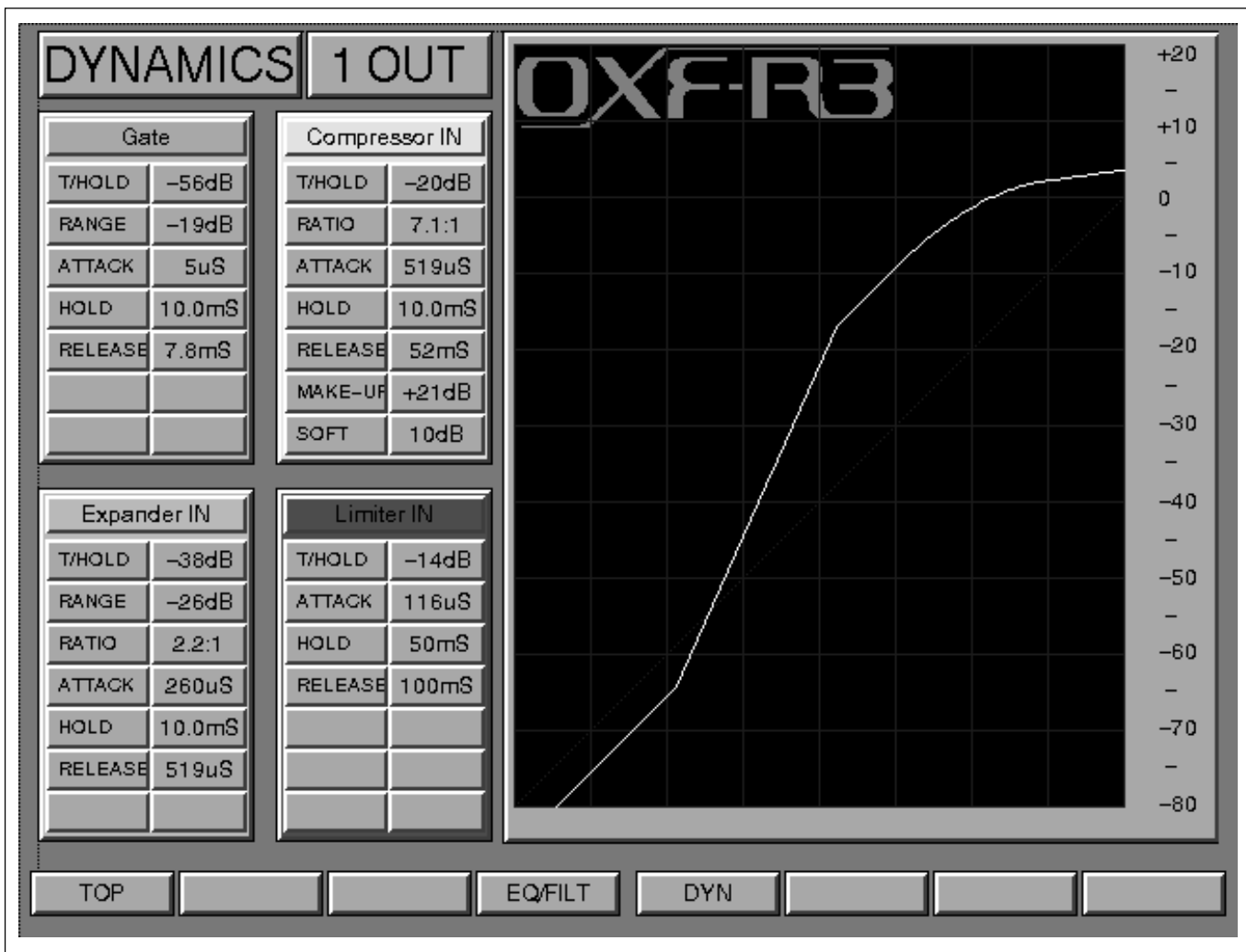

DYNAMICS GUI layout

This GUI functions in a similar manner to the Equaliser & Filters screen, displaying the knob setting parameters for the Gate, Expander, Compressor and Limiter simultaneously. The related dynamics transfer curve is displayed for the channel currently accessed.

In the graph displayed on this screen, the X axis has a range of -80dB (left) to 0dB (right, full scale) for the input scale. The Y axis represents the output scale from -80dB to +20dB. The output scale is expanded to +20dB at the top end to allow for any gain make-up to be displayed.

### 5-2-5 Preferences GUI

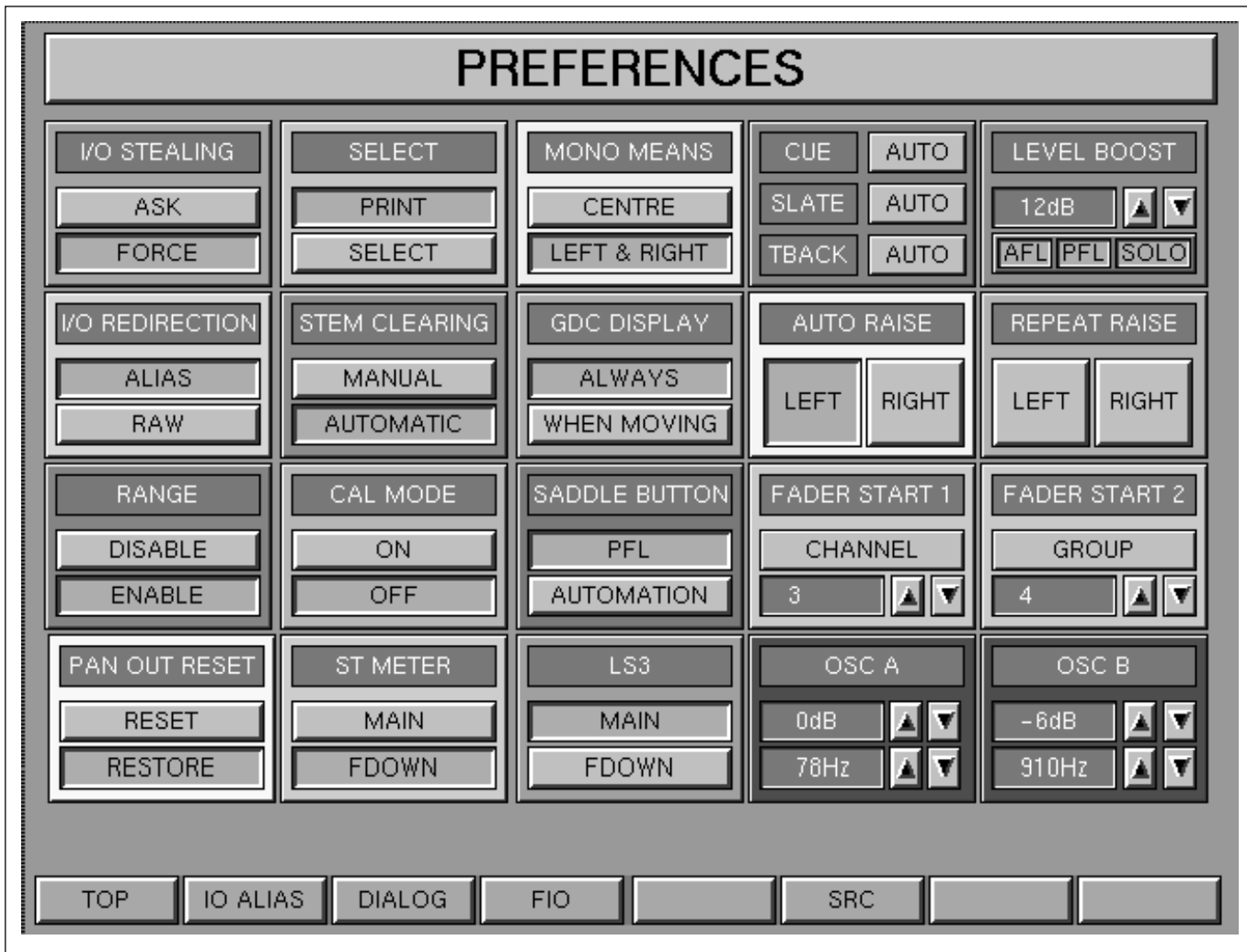

PREFERENCES GUI layout

#### General

Click on Preference options according to the following descriptions:

#### I/O STEALING

- **ASK** - A warning dialogue will appear when re-assigning I/O already in use, allowing the previous assignment to be retained.
- **FORCE** - I/O can be re-assigned without dialogue, irrespective of other assignments.

#### Note:

*The warning will never appear when the RANGE function is used. I/O will be assigned whether in use or not, without notification.*

## SELECT

Allows a one-shot print function of Mixer GUIs, such as I/O set-ups, using the SELECT buttons below the LCD screens in the channel sections.

- **PRINT** - Click on PRINT. Then, pressing SELECT below any LCD in the channels sections will cause an image of the GUI displayed to be printed, provided that the cursor is already in that screen. The selector then reverts to the normal SELECT function. PRINT must be clicked on again to print a second or further GUI.
- **SELECT** - Default function setting for the SELECT buttons below the LCD screens in the channel sections.

### Note:

*This print output function requires the system to be configured with a Postscript compatible printer.*

## MONO MEANS

Sets the destination LS when, for a mono signal, **MONO** is selected at the Monitor panel.

- **CENTRE** - Mono signal fed to the Centre LS.
- **LEFT & RIGHT** - Mono signal fed to both the Left and Right LS.

## MODES for COMMUNICATIONS BUTTONS

There are three button modes for each of CUE, SLATE and TBACK as below. Click on the buttons to the right of these labels accordingly.

- **MOM(entary)** - Press and hold.
- **LATCH(ing)** - Press for on and press again for off.
- **AUTO** - Combination mode: Press and hold for a momentary function, or short press to latch and another short press to release.

## LEVEL BOOST

Click on AFL, PFL or SOLO and then click on the ▲ and ▼ buttons to adjust monitor level beyond the default unity gain.

- **AFL** - Allows boost of up to 20dB in 1dB steps.
- **PFL** - Allows boost of up to 20dB in 1dB steps.
- **SOLO** - Allows boost of up to 20dB in 1dB steps.

## I/O REDIRECTION

- **ALIAS** - The specified 'alias' names, such as MIC 1, are displayed for I/O legends.
- **RAW** - The 'raw' names such as ADC 1 are displayed for I/O legends.

## STEM CLEARING

- **MANUAL** - Channel to stem routing is totally flexible allowing routing to multiple stems. Routing selections must be cleared manually.
- **AUTOMATIC** - Channel to stem routing selections for a particular Stem will be cleared automatically if another stem is selected. In other words, channels can route only to a single stem.

### GDC DISPLAY (Global Delay Compensation)

Option to set what is displayed in the 8 character dot display above the Global Display Compensation knob on the Free Assign Area & Dynamics panel.

- **ALWAYS** - Units of delay are indicated continuously.
- **WHEN MOVING** - GLOB DEL displayed until the knob is moved, when the units of delay are indicated, and remains for 3 seconds after release of the knob.

### AUTO RAISE

- **LEFT** - EQ & Dynamics GUIs are automatically displayed in the left channels section, above respective panels, when any EQ or Dynamics controls are adjusted.
- **RIGHT** - EQ & Dynamics GUIs are automatically displayed in the right channels section, above respective panels, when any EQ or Dynamics controls are adjusted.

### REPEAT RAISE

When assigning I/O, clicking on the source or destination device normally causes the pop-up to close. With the use of Repeat Raise, the pop-up remains open and increments the channel number for the same input or output for a further assignment and so on. Click on the red title bar at the top left when completed.

- **LEFT** - Repeat Raise operates for the left side of the console.
- **RIGHT** - Repeat Raise operates for the right side of the console.

### RANGE

- **DISABLE** - Disables the Range function.
- **ENABLE** - Allows consecutive numbered sections of I/O devices, of the same type, to be assigned to consecutive numbered sets of channels when using the I/O GUI.

### CAL MODE

Relates to the Surround LS Calibration settings for mixing to picture.

- **ON** - LS1 Monitor Outputs use their calibration settings.
- **OFF** - LS1 Monitor Outputs default to uncalibrated settings.

### SADDLE BUTTON

Option to allow the buttons in the middle of the Fader Knobs to be used for two different functions:

- **PFL** - Momentary PFL operation.
- **AUTOMATION** - Fader Automation drop-in to record fader moves.

### FADER STARTS 1 & 2

Two GPIO relay closure Fader Starts can be assigned to Channel or Control Group Faders.

- **Upper Button** - Click on to cycle through CHANNEL and GROUP Faders or OFF.
- **▲ ▼ Buttons** - Click to select the Channel or Group Fader number.

### PAN OUT RESET

- **RESET** - Switching a Pan out will centre it if switched in again.
- **RESTORE** - Switching a Pan out will centre it, but it will return to its previous setting if switched in again.

### ST METER

This option applies to the central stereo meter when **MAIN** is selected under the “METERS” heading at the top right of the Monitor panel.

- **MAIN** - Central stereo meter displays the L and R signals from the Main Output Bus.
- **FDOWN** - Central stereo meter displays the L and R signals derived in the Fold-Down Matrix.

### LS3

This option applies to the stereo CR Monitor LS3, when **MAIN** is selected under the “MONITORLS” heading at the middle right of the Monitor panel.

- **MAIN** - The LS3 feed is the L and R signals from the Main Output Bus.
- **FDOWN** - The LS3 feed is the L and R signals derived in the Fold-Down Matrix.

### OSC A & OSC B

Oscillators outputs A & B are controlled by clicking on ▲ and ▼ to the right of the parameter displays.

- **Level: dBs** - -100, -90, -80, -70, -60, -50, -40, -30 – 0dB in 1dB steps.
- **Frequency: Hz** - 20, 30, 40, 50, 60, 70, 80, 90, 100, 200, 300, 400, 500, 600, 700, 800, 900.
- **kHz** - 1, 2, 3, 4, 5, 6, 7, 8, 9, 10, 12, 14, 16, and 20.

### The Softkeys for this GUI:

- **TOP** - Selects the top level LOGO screen
- **IO ALIAS** - Alias naming facility for all types of I/O
- **DIALOG** - Naming facility for all I/O Scribble pop-ups
- **FIO MONO** - Set-up facility for Fast Insert I/O
- **SRC** - Sample Rate Converter control

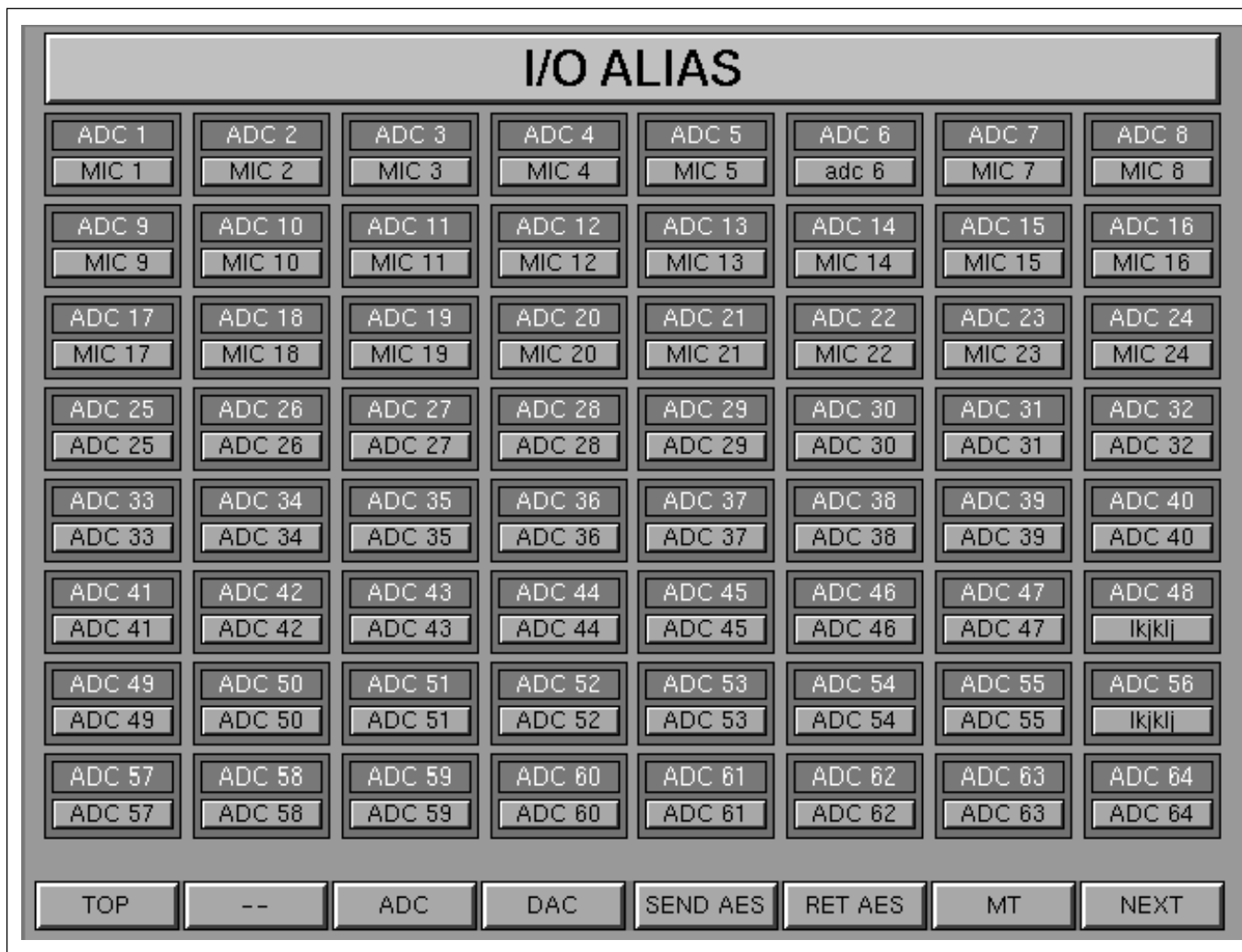

PREFERENCES GUI - I/O ALIAS page layout

### General

This GUI allows I/O objects to be given names which can relate to the local environment. ADC 1 could be named MIC 1, for example, which might relate to a particular microphone input socket on a panel in the studio. So instead of ADC 1 appearing in the I/O assignment GUI, MIC 1 will be displayed, provided 'Alias' is selected in the PREFERENCES GUI.

### NAME – Lower field

Click on this to display a pop-up. Enter a name of up to 6 characters using the QWERTY keyboard. Press ENTER when finished.

### The Softkeys for this GUI:

- **TOP** - Selects the top level LOGO screen
- **ADC** - Alias names for ADCs
- **DAC** - Alias names for DACs
- **SEND AES** - Alias names for AES I/O Outputs
- **RET AES** - Alias names for AES I/O Inputs
- **MT** - Alias names for MADI Multitrack Returns
- **NEXT** - Further pages of ADCs, DACs, AES & MADI I/O



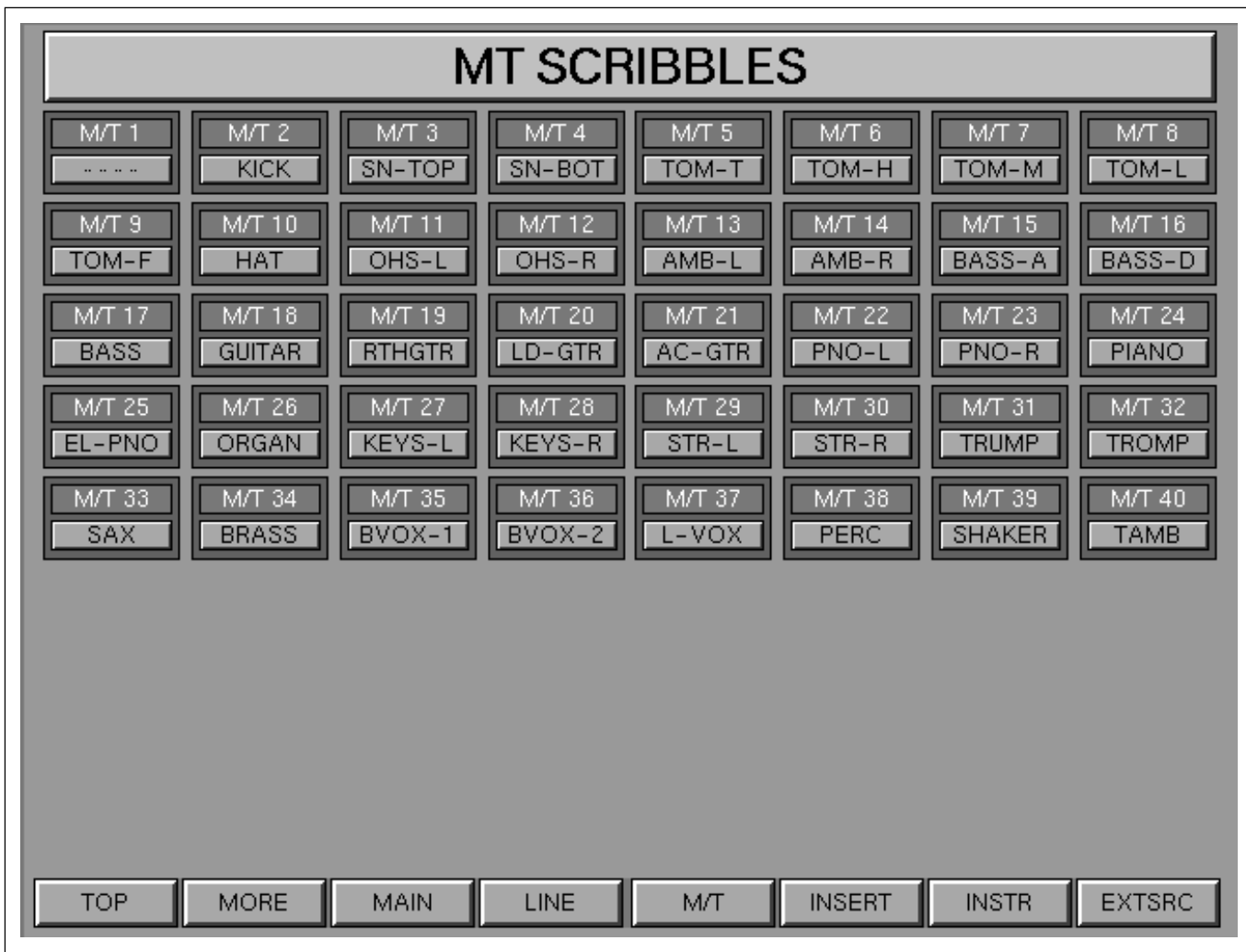

PREFERENCES GUI - MULTITRACK SCRIBBLES page layout (Select 'DIALOG' at the PREFERENCES GUI)

### General

The majority of I/O assignments can have names associated with them which may be displayed on GUIs and electronic scribbles. This GUI allows customisation of the scribble name pop-ups allowing frequently used pre-set names to be listed and edited.

### NAME – Lower field

Click on this to display a pop-up. Enter a name of up to 6 characters using the QWERTY keyboard. Press ENTER when finished.

### The Softkeys for this GUI:

- **TOP** - Selects the top level LOGO screen
- **MORE** - Further page for naming scribbles (MIDI, TRACK & GROUP)
- **MAIN** - Main Output names (SSGs, Sends etc) pop-up
- **LINE** - Line Inputs names pop-up
- **M/T** - Multitrack Return Inputs names pop-up
- **INSERT** - Insert names pop-up
- **INSTR** - Instrument names pop-up (MIC Inputs)
- **EXTSRC** - External Source names pop-up

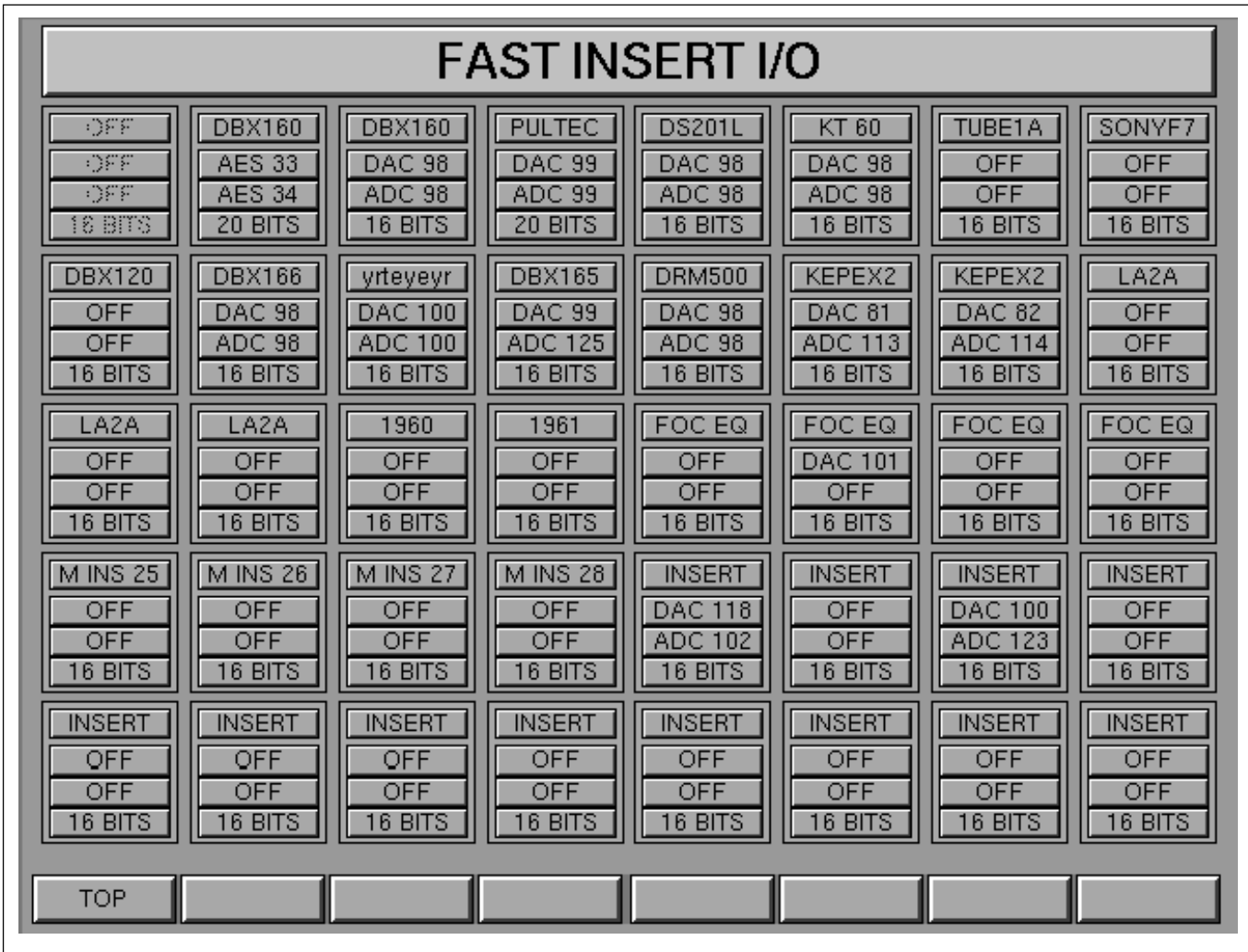

PREFERENCES GUI - FAST INSERT I/O set-up page layout

**General**

This GUI allows the setting up of Send I/O, Return I/O and Electronic Scribble names for devices used via Channel Inserts. The preset FAST INSERTs are accessed via the channel I/O GUI.

**Setting up FAST INSERT I/O**

Each of the 40 blocks in the GUI has 4 clickable fields as follows:

**Note:**

*The following description applies to Mono Inserts. Stereo Inserts have an additional field since there are left and right audio paths.*

**NAME – Upper field**

Click on the upper field for a pop-up to name the insert device to be assigned. This name will appear in an 8-character display at the Input Channel & Inserts panel when the Insert function is selected. Click on a suitable name already in the list or select NEW ENTRY and use the QWERTY keyboard to type in a new name of up to 8 characters. Press ENTER when finished.

### **INSERT SEND – Second field**

The second field is used to specify an I/O destination for the selected Insert Send. Click on this for a pop-up displaying possible destinations. Click on the desired DAC to assign an analogue Send or, for a digital output, click on AES for the digital destinations. Further pages of related pop-ups can be accessed by clicking on Prev. or Next. Click on OFF to disable a Send.

### **INSERT RETURN – Third field**

The third field is used to select the I/O Insert Return source for the channel. Click on this for a pop-up displaying possible return sources. Click on the desired ADC for an analogue return source or click on AES for the digital return sources. Further pages of related pop-ups can be accessed by clicking on ◀ or ▶. Click on OFF to disable a Return.

### **WORD LENGTH – Fourth field**

The fourth (lowest) field allows the insert Send and Return word length to be set, if the insert device is digital. Click on it to cycle through the word lengths 16 bit, 20 bit and 24 bits. It will be set for both send and return simultaneously.

**Note:**

*Although the word length field is operable when analogue I/O is selected, it only affects digital I/O.*

### **The Softkeys for this GUI:**

- **TOP** - Selects the top level LOGO screen

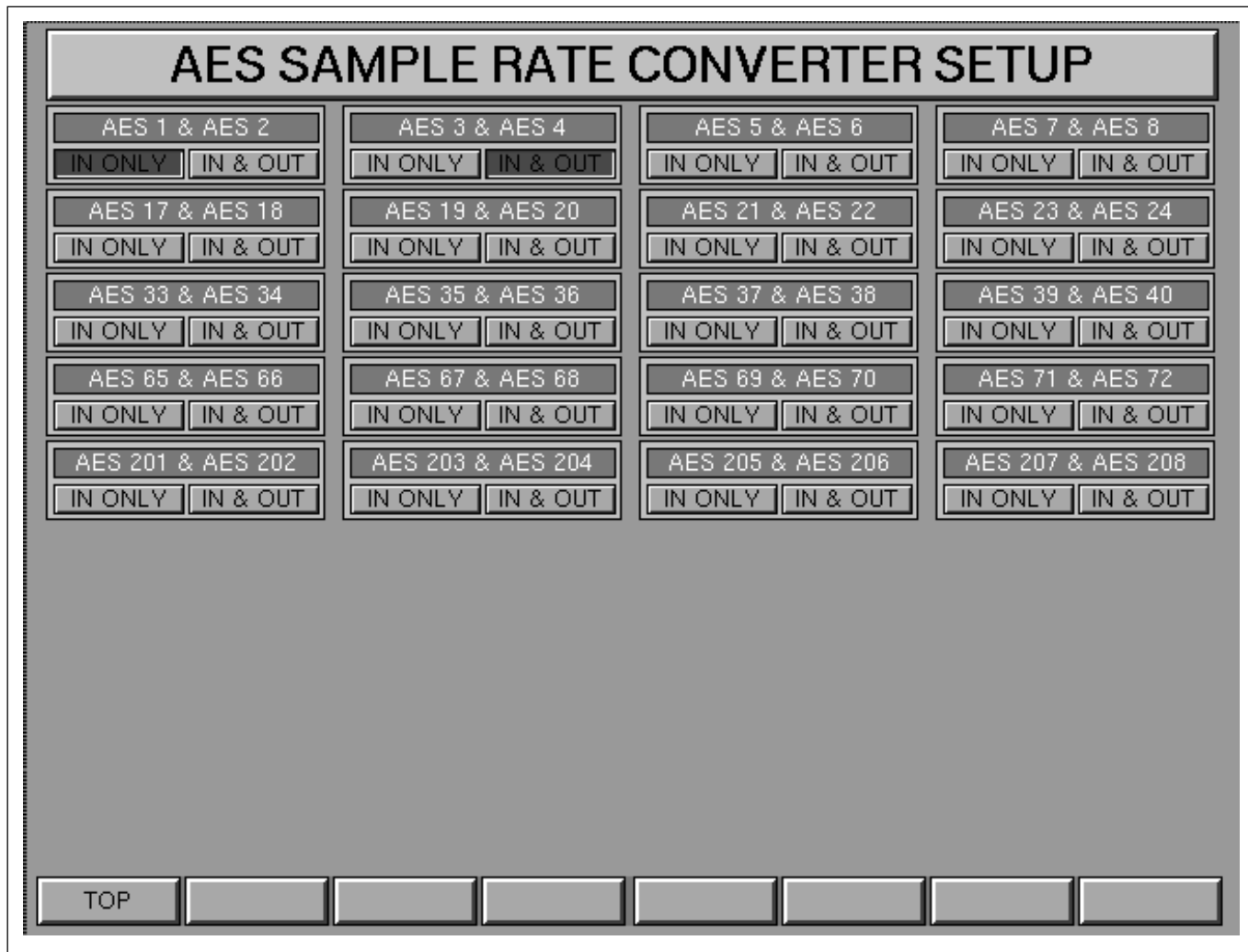

AES SAMPLE RATE CONVERTER SETUP GUI

### General

This GUI allows Sample Rate Converters (SRCs) to be switched in and out on AES Digital I/O.

SRCs are switchable in odd/even pairs only for:

- **INPUTS**
- **INPUTS & OUTPUTS**

### Note:

*It is not possible to select an SRC to an Output alone. This because a clock signal must be extracted from a source outside the system and this is acquired from AES inputs.*

### The Softkeys for this GUI:

- **TOP** - Selects the top level LOGO screen

## 5-2-6 MASTER GUI

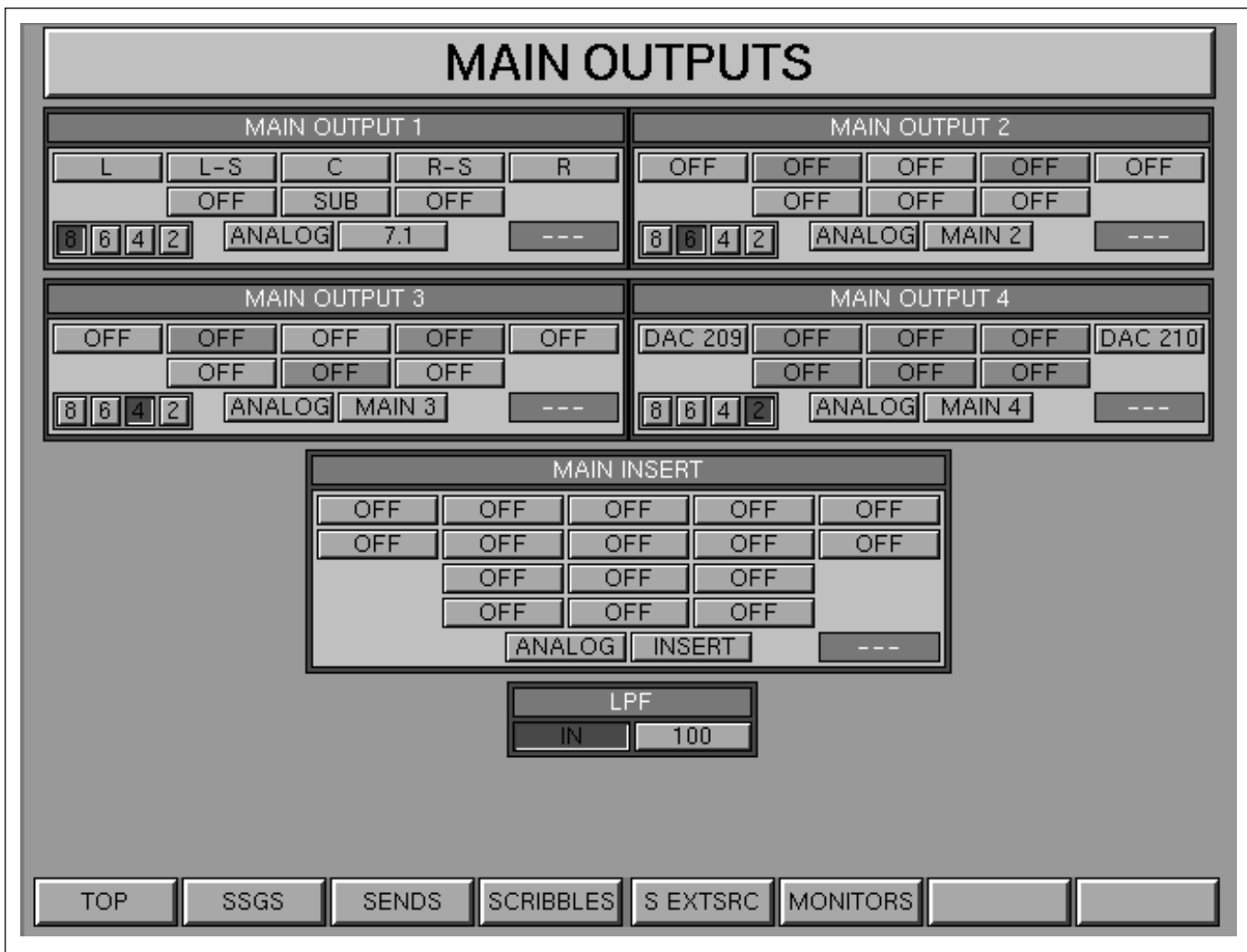

MASTER GUI layout

### This GUI allows assignment of:

- MAIN OUTPUT BUS (4 separate outputs)
- MAIN BUS INSERTs

### General

The MAIN OUTPUTS GUI allows assignments of all master bus outputs, their inserts and external monitor inputs etc. A number of pages can be accessed using softkeys at the bottom of the screen.

### The Softkeys for this GUI:

- TOP - Selects the top level LOGO screen
- SSGS - Super Send Group Outputs & Inserts
- SENDS - Send Outputs
- SCRIBBLES - Control Group & Talkback Scribbles
- S EXTSRC - Stereo & Multi-Channel External Sources
- MONITORS - Control Room Monitors, Studio LS, F/back, T/back & Oscillators

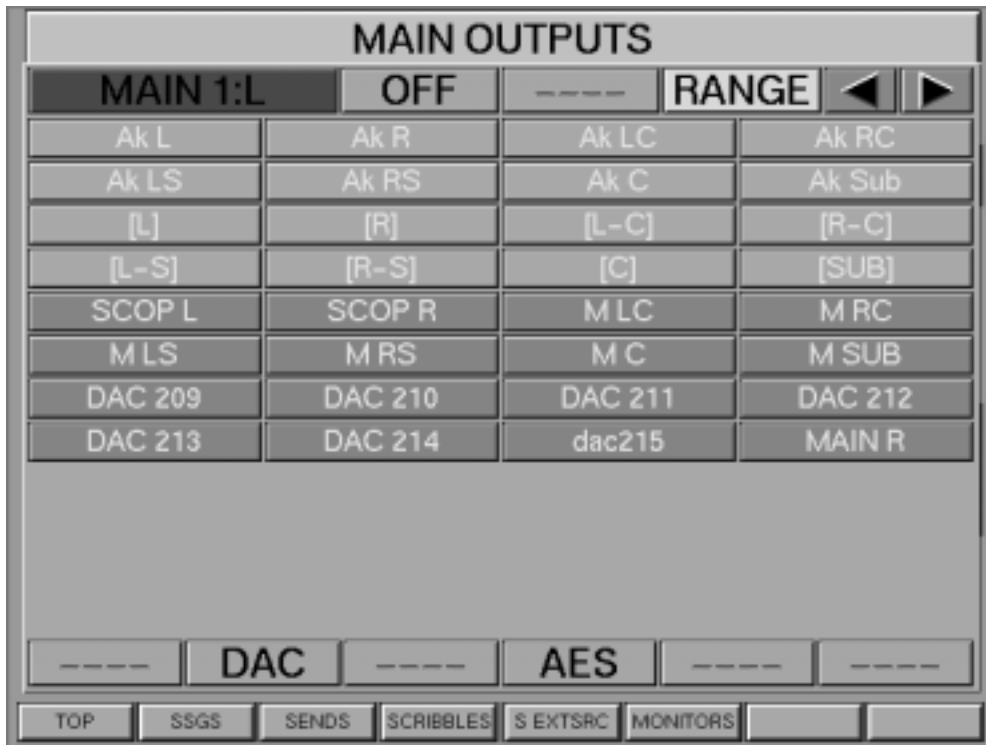

Figure A

MASTER GUI - MAIN OUTPUT BUS output pop-up

**Note:**

*Whilst the following describes selecting destinations and inserts for the MAIN BUS, the methods of operation apply to all pages related to the MASTER GUI.*

**General**

The clickable fields in the Main Output GUI are laid out in the form of a set of Surround LS. The upper section contains a single set of Inserts which affect all four outputs.

**OUTPUT FORMAT – MAIN OUTPUT 1 upper section**

The 8 fields labelled [L], [L-S], etc. allow the selection of I/O destinations for the Main Output 1. Eight fields are displayed in the illustration, but the number displayed depends upon the current format for the Main Output Bus. Click on any of these fields to display the pop-up as shown in Figure A, which lists analogue outputs. Click on one of them to select it or click on AES for the list of digital destinations.

**OUTPUT FORMAT – MAIN OUTPUT 1 lower left**

The 4 buttons labelled [8], [6], [4], and [2] inter-cancel allowing the setting of the format for the output, 7.1, 5.1, LCRS or Stereo respectively. A Fold-down Matrix derives signals for formats with fewer outputs than the Main Bus.

**WORD LENGTH – MAIN OUTPUT 1 lower middle left**

This field is displaying 'ANALOGUE' in the illustration, since analogue



Figure B

MASTER GUI - MAIN OUTPUT BUS scribble pop-up

outputs have been selected. When digital outputs are set, the Word Length is displayed here. Clicking on it cycles through 16, 20 and 24 bit settings.

**NAME – MAIN OUTPUT 1 lower middle right**

Click on this to display a pop-up as shown in Figure B. Either click on a name already displayed or click on NEW ENTRY and use the QWERTY keyboard to type in a name of up to 8 characters. Press ENTER when finished.

**SAMPLE RATE CONVERTER – MAIN OUTPUT 1 lower right**

This indicator turns red and reads “SRC ON” when a digital source is selected which has its SRC turned on. SRCs are controlled via the PREFERENCES GUI, described earlier in this chapter.

**MAIN OUTPUTS 2, 3 & 4**

The assignment operations for MAIN OUTPUT 1 apply to 2, 3 and 4.

**LP FILTER – Lower middle block**

Low Pass Filter for the SUB output. Click on the lower left button to switch the filter section in and out of the signal path. Set the frequency with the button to the lower right, 70 or 100Hz. The slope is 24dB/Octave.

**To assign an insert on the MAIN OUTPUT BUS**

The Insert selectors are laid out in the form of a set of Surround LS in the section headed ‘MAININSERT’.

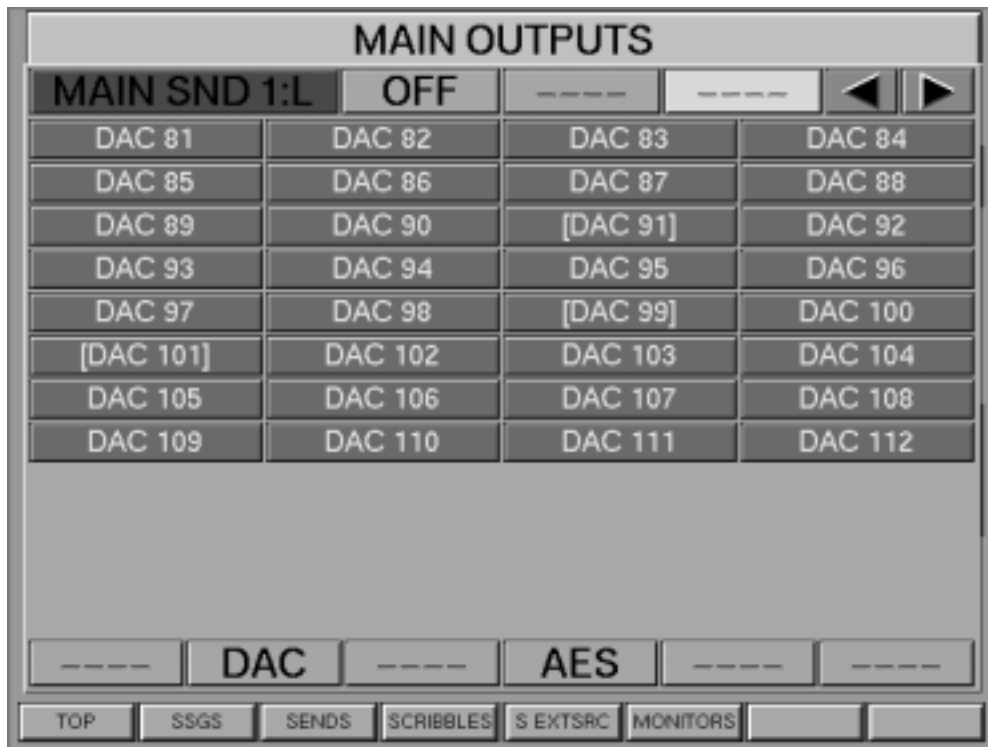

Figure C

MASTER GUI - MAIN OUTPUT BUS insert pop-up

### MAIN INSERT SEND – Upper field

Click on an upper field of one of the 8 block pairs for the Insert Send pop-up displaying possible destinations. Figure C shows analogue destinations in the form of DAC outputs. Click on the desired DAC number to assign a Send. For a digital output, click on AES for the list of digital destinations. Click OFF to disable a Send.

### MAIN INSERT RETURN – lower field

Click on a lower field of one of the 8 block pairs for the Insert Return pop-up in order to display sources. Click on the desired analogue return source or click on AES for the digital return sources list.

### WORD LENGTH – MAIN INSERT 1 lower middle left

When digital outputs are assigned, the Word Length is displayed here. Clicking on it cycles through 16, 20 and 24 bit settings.

### NAME – MAIN INSERT 1 lower middle right

Click on this to display a pop-up. Either click on a name already in the list or select NEW ENTRY and use the QWERTY keyboard to type in a new name of up to 8 characters. Press ENTER when finished.

### SAMPLE RATE CONVERTER – MAIN INSERT 1 lower right

This indicator turns red and reads "SRC ON" when digital I/O is selected which has its SRC turned on. SRCs are controlled via the PREFERENCES GUI, described earlier in this chapter.



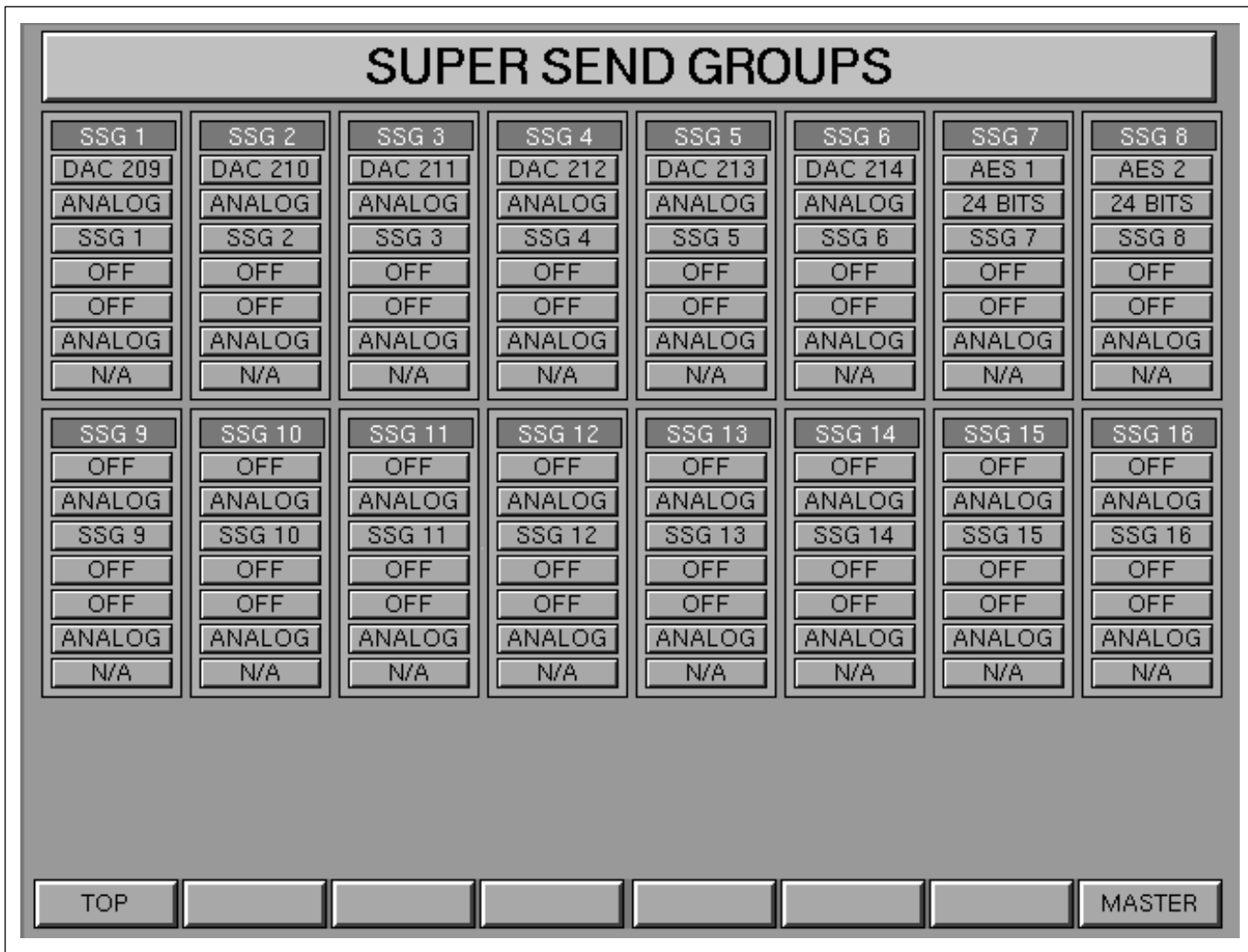

MASTER GUI - SUPER SEND GROUPS Outputs and Inserts page layout

**This GUI allows assignment of:**

- SUPER SEND GROUP Outputs 1-16
- SUPER SEND GROUPS 1-16 Inserts

**The Softkeys for this GUI:**

- TOP - Selects the top level LOGO screen
- MASTER - Selects the top level MASTER screen

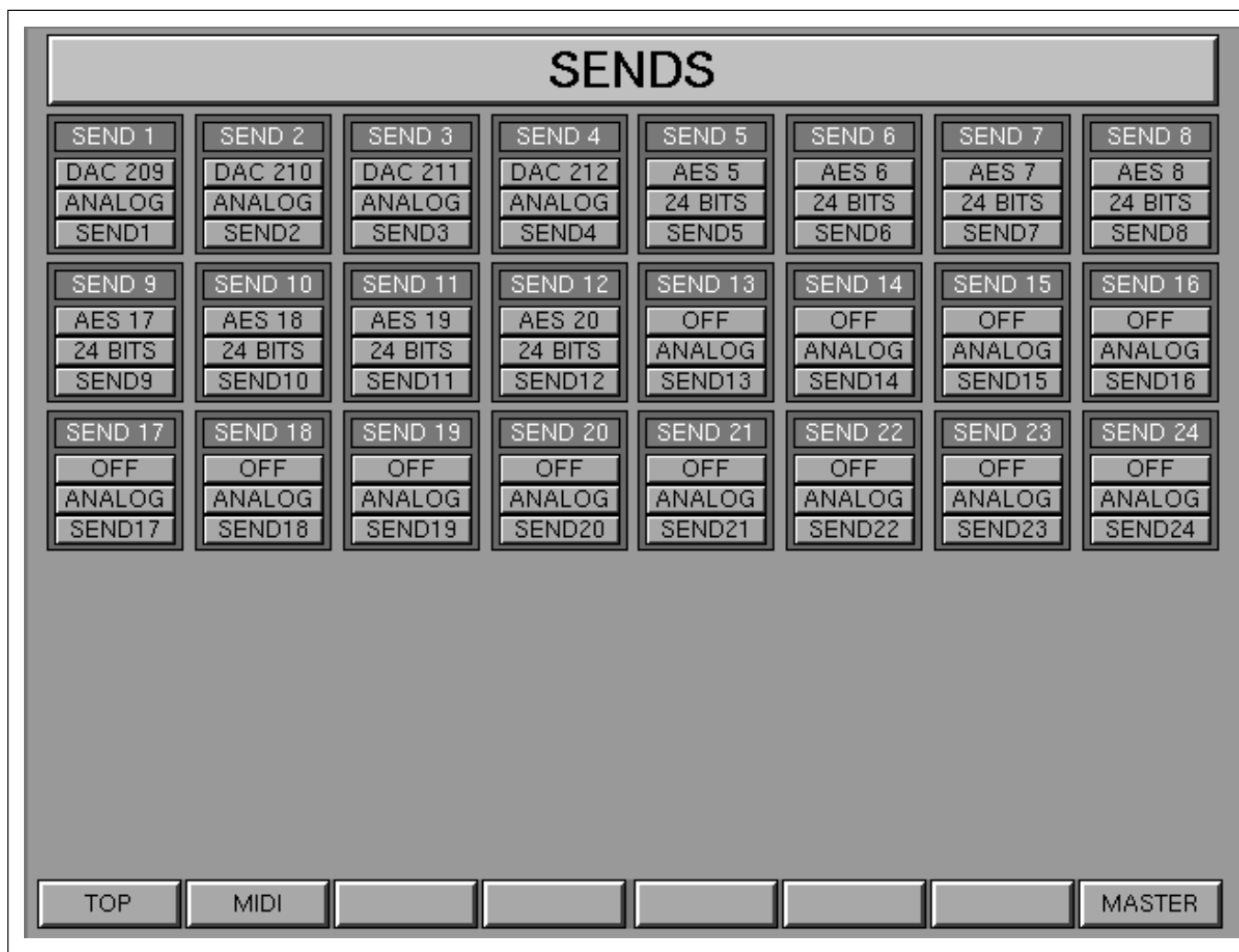

MASTER GUI - SEND OUTPUTS page layout

**This GUI allows assignment of:**

- SEND Bus Outputs 1-24
- MIDI Control Pages 1-24

**The Softkeys for this GUI:**

- TOP - Selects the top level LOGO screen
- MIDI - Selects the MIDI page with the same number as the currently accessed Send Output
- MASTER - Selects the top level MASTER screen

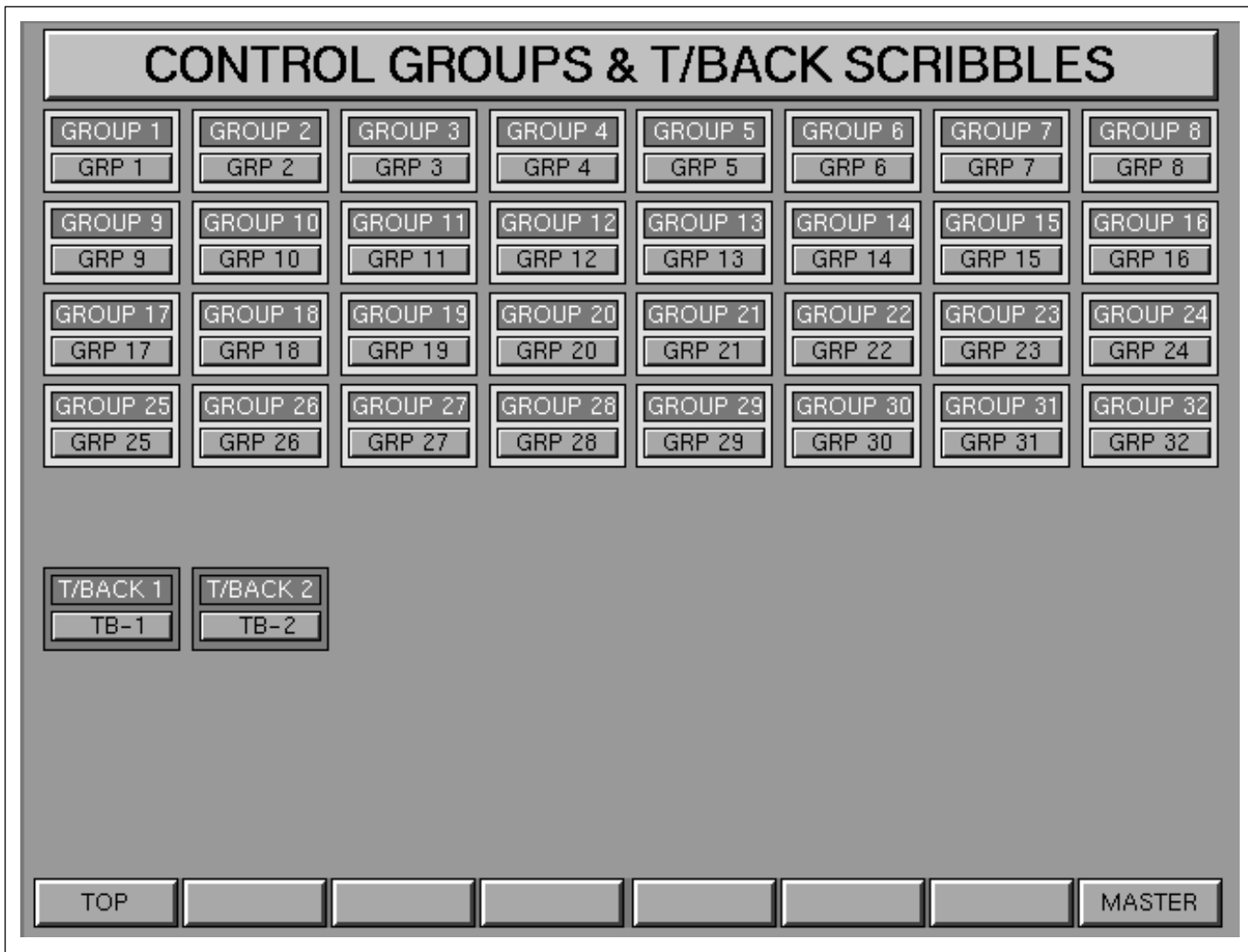

MASTER GUI SCRIBBLES - CONTROL GROUP & SCRIBBLES page layout

**This GUI allows scribble name assignment for:**

- CONTROL GROUP FADERS
- TALKBACK SCRIBBLES

**The Softkeys for this GUI:**

- TOP - Selects the top level LOGO screen
- MASTER - Selects the top level MASTER screen

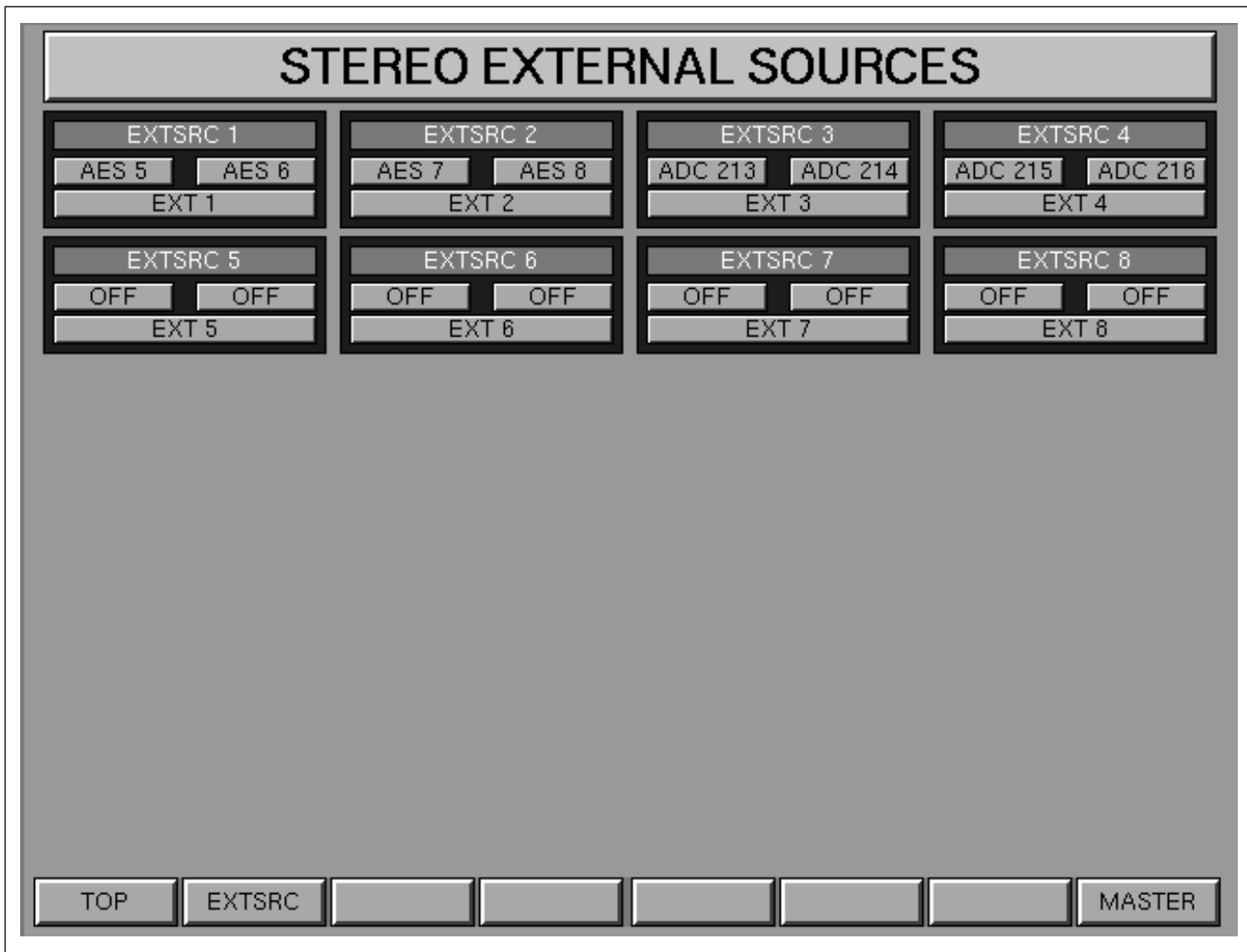

MASTER GUI - STEREO EXTERNAL SOURCES page layout

**This GUI allows assignment of:**

- **STEREO EXTERNAL SOURCES 1-8**  
(Select using the EXT SOURCE buttons in the Monitor Panel to listen to them)

**The Softkeys for this GUI:**

- **TOP**                    - Selects the top level LOGO screen
- **EXTSRC**                - Selects Surround EXTERNAL SOURCES
- **MASTER**                - Selects the top level MASTER screen

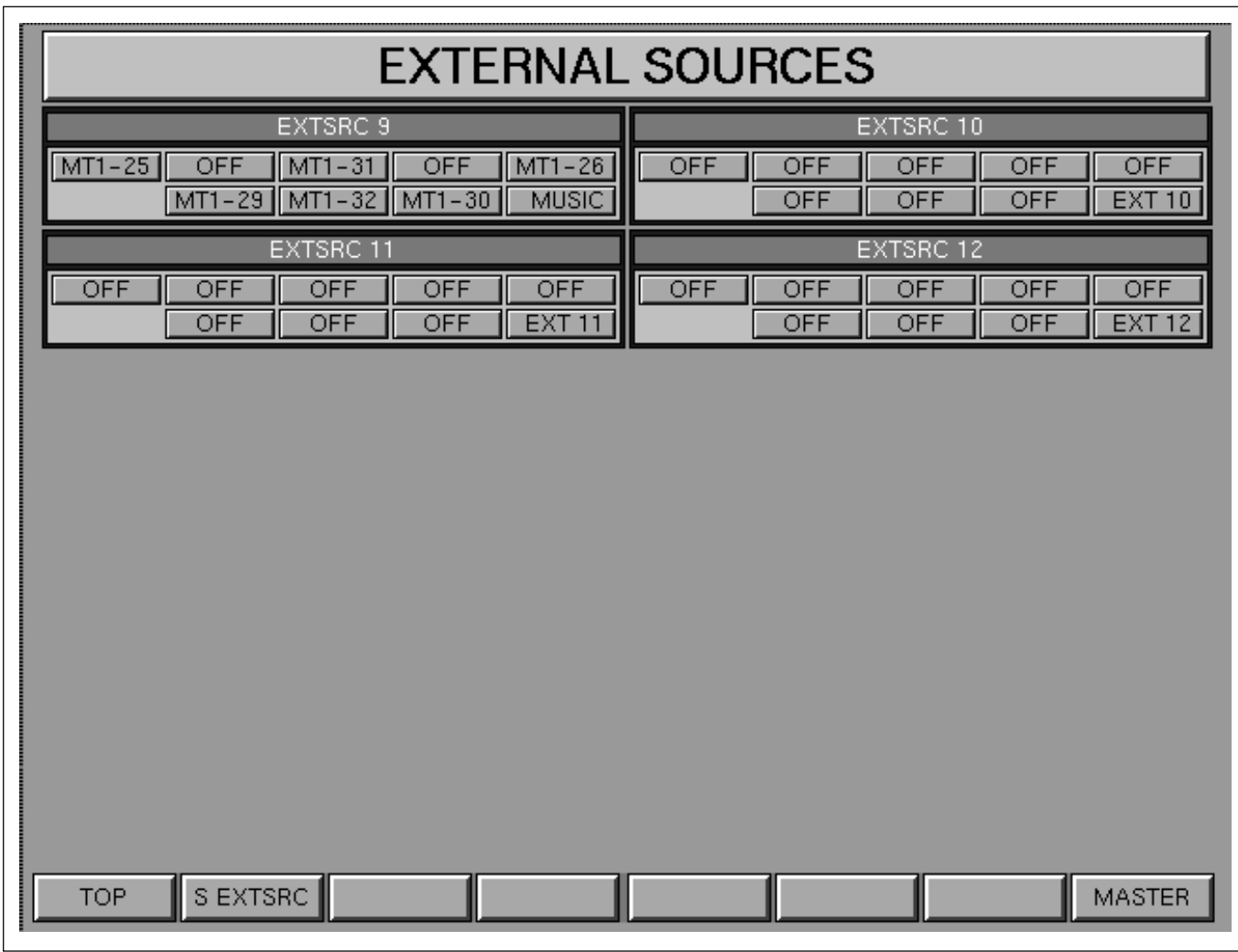

MASTER GUI - Surround EXTERNAL SOURCES page layout

**This GUI allows assignment of:**

- **MULTI-FORMAT EXTERNAL SOURCE Inputs 1-6**  
(Select using the EXT SOURCE buttons in the Monitor Panel to listen to them)

**The Softkeys for this GUI:**

- **TOP** - Selects the top level LOGO screen
- **S EXTSRC** - Selects STEREO EXTERNAL SOURCES
- **MASTER** - Selects the top level MASTER screen

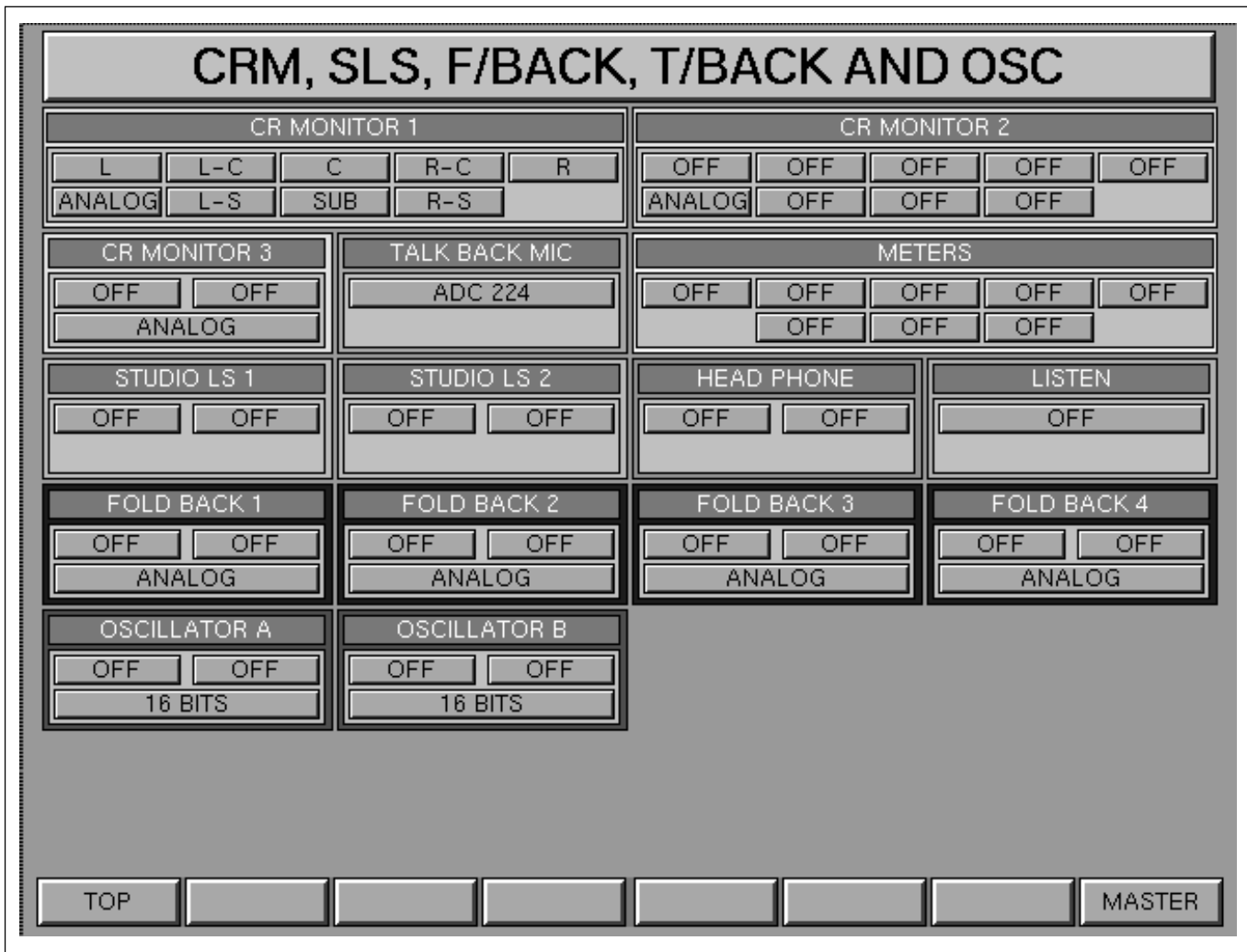

MASTER GUI - Monitors and misc. assignments page layout

**This GUI allows assignment of:**

- CONTROL ROOM MONITOR LS Outputs 1, 2 & 3
- TALKBACK MIC
- METERS - Output for Signals Feeding Central Meters
- STUDIO LS Outputs 1 & 2
- HEADPHONE Output 1
- LISTEN Mic
- FOLDBACK Outputs 1-4
- OSCILLATOR A and B Outputs

**The Softkeys for this GUI:**

- TOP - Selects the top level LOGO screen
- MASTER - Selects the top level MASTER screen

# Chapter 6 – Technical Descriptions

This chapter provides descriptions of the OXF-R3 system, including the location and function of all elements of the system. The control surface layout and functions are described in detail.

*For details of the signal flow in the OXF-R3 system, refer to the Signal Flow Block Diagram in Chapter 1, Overview.*

## Chapter 6 Contents

<b>6-1 OXF-R3 System Description .....</b>	<b>6-2</b>
6-1-1 Control Surface Configurations .....	6-3
<b>6-2 Channels Section Panels .....</b>	<b>6-6</b>
6-2-1 Fader Panel .....	6-6
6-2-2 Select to Faders Panel .....	6-9
6-2-3 Pans Panel .....	6-13
6-2-4 Select to Pans Panel .....	6-15
6-2-5 Input and Equaliser Panel .....	6-17
6-2-6 Free Assign Area & Dynamics Panel .....	6-20
6-2-7 Multitrack Panel .....	6-25
6-2-8 Routing Panel .....	6-28
6-2-9 LCD Channel Screen Panel .....	6-31
6-2-10 Sends 1-24 Panel .....	6-32
<b>6-3 Central Section Panels .....</b>	<b>6-38</b>
6-3-1 Master Fader Panel .....	6-38
6-3-2 Monitor Panel .....	6-39
6-3-3 Control Keyboard Panel .....	6-62
6-3-4 Super Send Groups, Send Outputs and Multi-Format Panel .....	6-76
6-3-5 Central Section Faders .....	6-86
6-3-6 Control LCD Screen Panel .....	6-87
6-3-7 QWERTY Keyboard .....	6-88
6-3-8 Trackerballs .....	6-89
<b>6-4 Meter Bridge .....</b>	<b>6-90</b>
6-4-1 Mono Channel Meters .....	6-90
6-4-2 Stereo Centre Section Meters .....	6-92
6-4-3 Other Meter Bridge Indicators .....	6-95
<b>6-5 Signal Processing Rack .....</b>	<b>6-96</b>
6-5-1 SP Rack Modules .....	6-96
<b>6-6 I/O Racks .....</b>	<b>6-97</b>
6-6-1 I/O Rack Modules .....	6-97

# 6-1 OXF-R3 System Description

The OXF-R3 digital audio mixing console comprises four main elements:

- Control Console with Modular Control Surface
- Host Computer
- Signal Processing (SP) Rack
- Digital and Analogue I/O Rack(s)

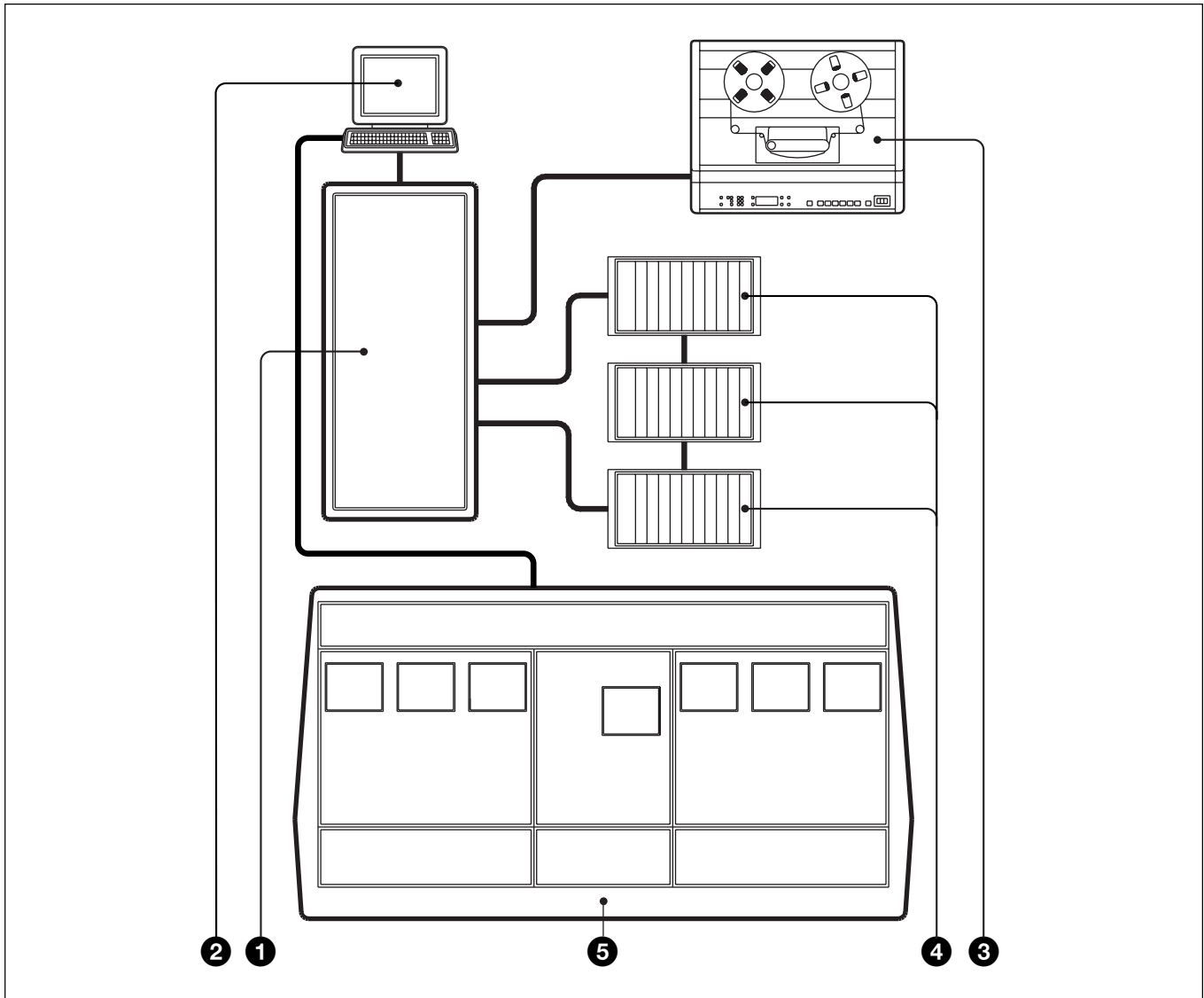

System Concept diagram

- 1 SP Rack
- 2 Host Computer
- 3 Multitrack Tape Recorder(s)
- 4 Digital & Analogue I/O Rack(s)
- 5 Control Console



## 6-1-1 Control Surface Configurations

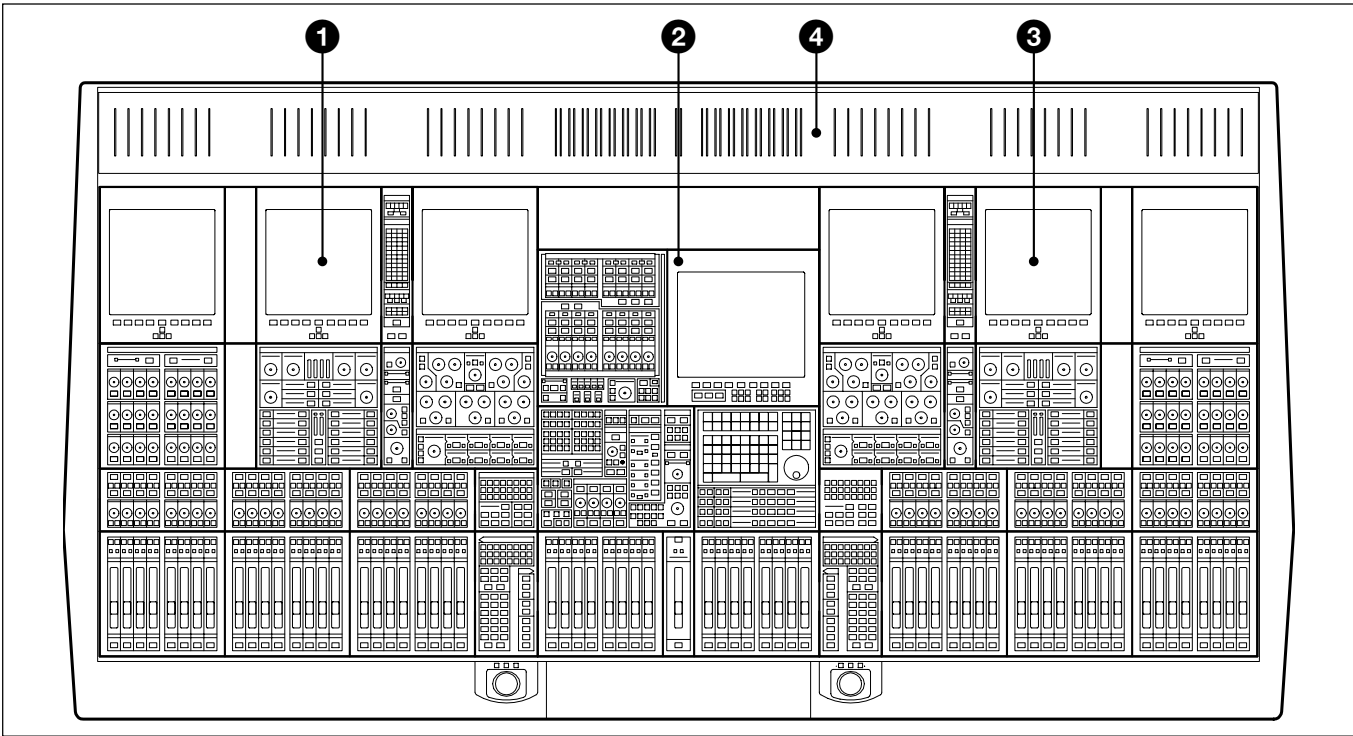

24-C-24 Control Surface Configuration

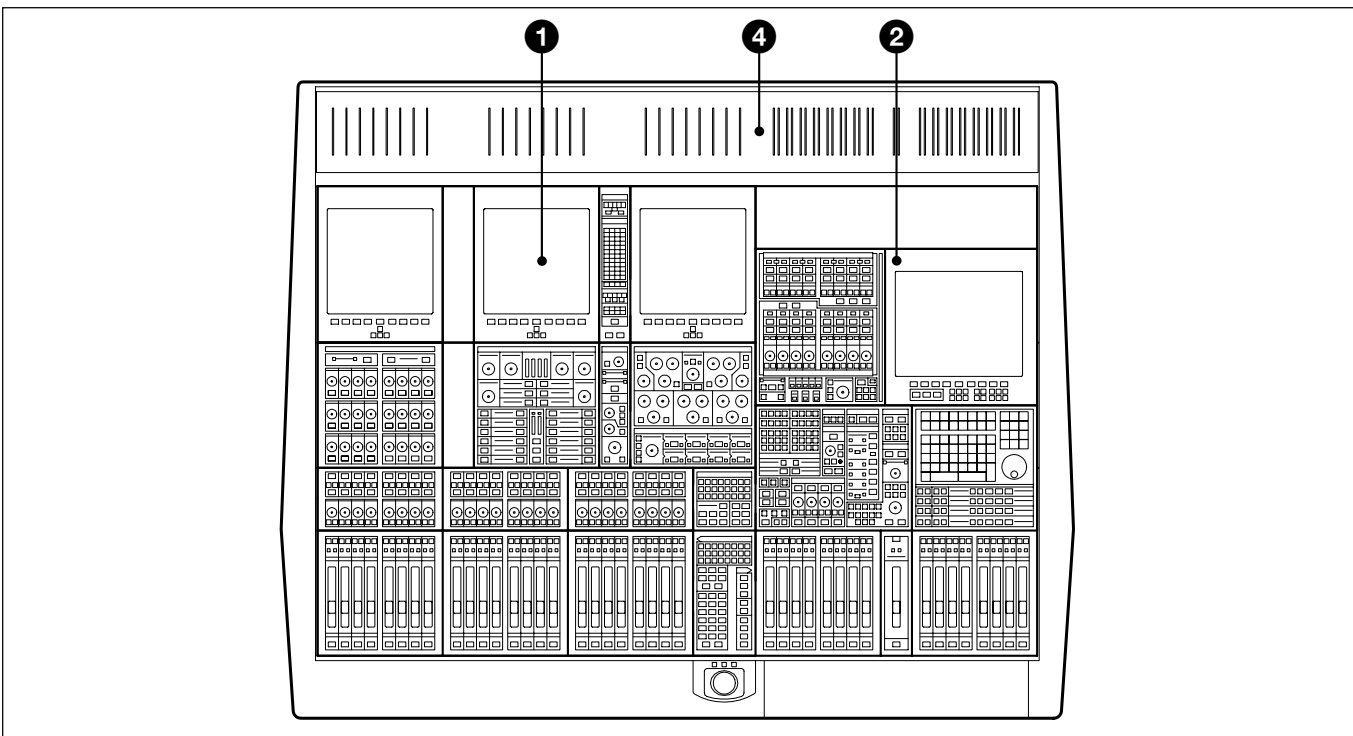

24-C-0 Control Surface Configuration

- ❶ Left Hand 24 Fader Channels Section**
- ❸ Right Hand 24 Fader Channels Section**
- ❷ Central Master Section**
- ❹ Meter Bridge**

## 6-1 OXF-R3 System Description

---

A key feature of the OXF-R3 is that it has Assignable Panels. These can be broken down into 4 basic areas:

- **INPUT CHANNEL, EQUALISER and FILTERS**
- **FREE ASSIGN and DYNAMICS AREA**
- **ROUTING and MULTITRACK**
- **SENDS AREA** (for feeding effects and foldbacks etc)

### **INPUT CHANNEL, EQUALISER and FILTERS**

The Input Channel section is much more flexible than a conventional in-line analogue channel strip in that it allows processing elements to be configured in almost any order.

The 5 Band Equaliser and High and Low Filters sections are independent and can be assigned separately to any position in the channel signal path.

### **FREE ASSIGN AREA and DYNAMICS**

- **GATE**
- **EXPANDER**
- **COMPRESSOR**
- **LIMITER**
- **SIDE-CHAIN EQUALISER (S-C EQ)**

Each section of the Dynamics has its own side-chain and allows very comprehensive control, equivalent to that of high spec outboard units. All the side-chains operate on a single gain control element. The Side-Chain EQ is a 2-band fully parametric element which may be inserted in three ways:

- in the Dynamics Side-Chain only
- in the Signal Path and the Side-Chain
- in the Signal Path only, as a second EQ.

- **DELAY EFFECT**

This area includes space for additional effects to be controlled as software upgrades are introduced.

### **ROUTING and MULTITRACK**

- **MULTITRACK**

The Multitrack section is configurable in two ways, either as part of an in-line channel or in a parallel mode, where a multi-channel recording is being made during a live mix, for example.

---

## • **ROUTING**

The Routing section splits into three areas:

- Multitrack Busses 1-48
- Main Output Bus and Super Send Groups 1-16
- Multi-format Monitor

Although just one set of buttons (which follow the channel assignments) is available at each side of the console, 48 channels worth of routing can be displayed simultaneously, with 24 channels being displayed on the LCD screens on each side of the control surface.

## **SENDS**

There are 24 mono Sends that can be linked up as odd/even pairs to provide up to 12 stereos. The levels to the busses can be set using the individual dedicated controls or, alternatively, they can be assigned, one bus at a time, to the faders or assignable knobs (PANs).

*In the following panel descriptions, the location of the panel being described will be indicated by an inset view of the OXF-R3 control surface with that panel (or panels of that type) shown highlighted.*

## 6-2 Channels Section Panels

The following descriptions apply equally to the left and right hand channels sections, which are mirror images of each other.

### 6-2-1 Fader Panel

#### General

Each Fader Panel (three left and three right) contains 8 touch sensitive linear motorised faders with associated electronic dot display scribbles and local dynamic automation controls. This universal Fader Panel is used for channels as well as master section functions.

The faders are very important devices in that all channel level control functions may be accomplished using them as selected on the SELECT TO FADERS panel described in the next section. Channel faders may be switched to control:

- **INPUT GAIN** Mic, M/T and Line
- **M/T SEND** Level sent to M/T Bus
- **GROUP TRIM** Gain of M/T Bus Output to M/T Channel
- **M/T MONITOR** Level Sent to Independent M/T Monitor Bus
- **CHANNEL** Level Sent to Main L/R Output Busses
- **SENDS** Levels Sent to Effects & Foldback Outputs
- **SUB LEVEL** Levels Sent to the Sub Bus in Multi-Format Mode

#### Control Group function

Any fader can be linked or 'slaved' to be controlled by any one of the centrally placed Control Group Faders. This works exactly like VCA grouping in an analogue console. Slaves can be set to move according to Control Groups by latching **SLAVE FADs MOVE** on the Monitor panel.

See 6-3-2 for **SLAVE FADs MOVE** function.

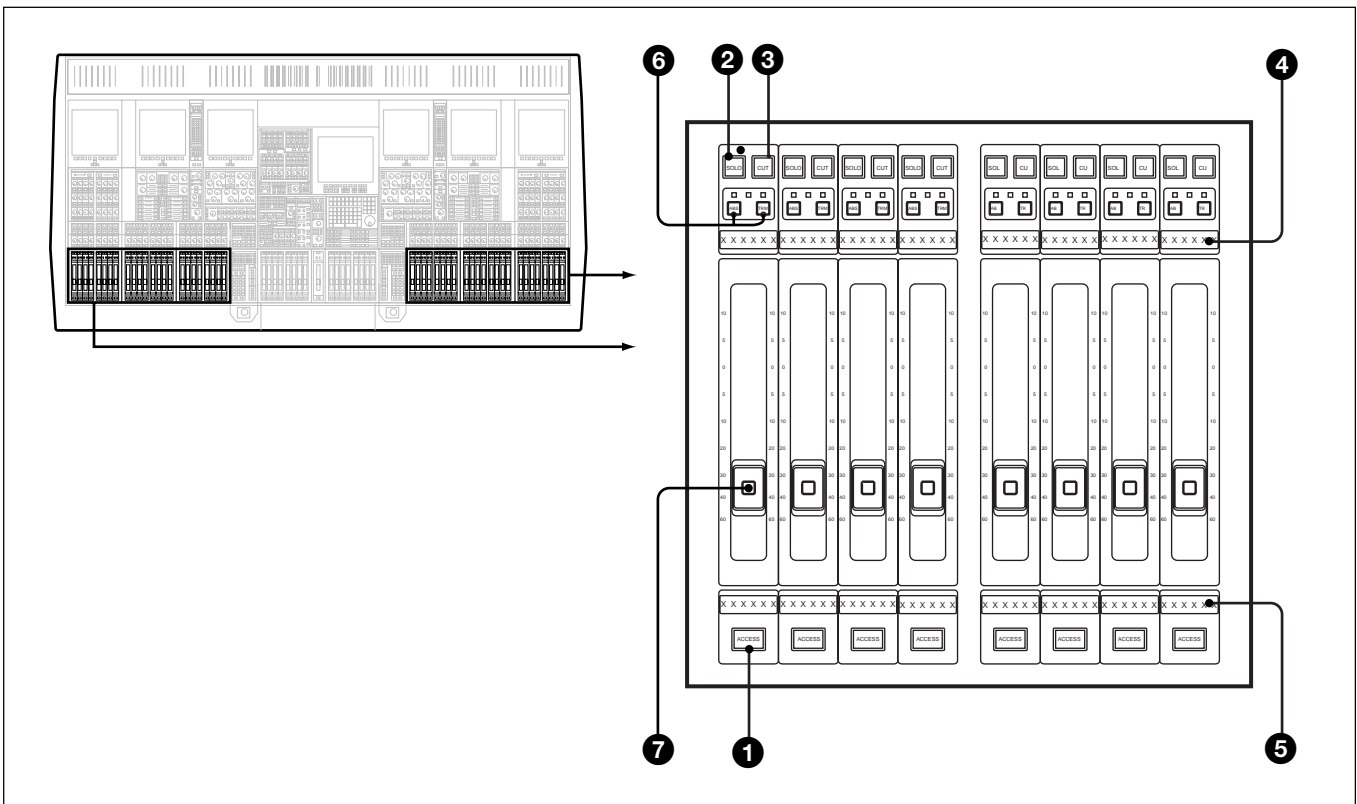

Fader panel

### ❶ ACCESS Push-Button

Selects the set of channel process and routing controls above the faders area to its channel.

### ❷ SOLO Push-Button

The function of fader Solo push-buttons is dependent upon the master status set on the Monitor Panel in the centre section:

Master Status SOLO - Allows a destructive SOLO function which works on CHANS at all times and M/T SEND faders when in Multi-format mode only. In this mode, CUT buttons light on other channels. AFL (After Fader Listen) functions for all other selections, INPUT GAIN, GROUP TRIM and M/T MON. AFL does not function for Sends 1-24.

Master Status AFL - Sends the AFL signal to the monitor LS for whichever function is assigned to the faders at the time, not including Sends 1-24.

Master Status PFL - Sends the PFL (Pre Fader Listen) signal to the monitor LS for CHANS at all times and M/T SEND faders when in Multi-format mode only.

### ❸ CUT Push-Button

Mutes the signal for whichever level function the fader is performing at the time.

## 6-2 Channels Section Panels

---

### ④ Upper Electronic Scribble (6 Character dot display per Fader)

Displays the audio source name. This may be selected from a table of source names via colour LCD screens when selecting signal sources. The name may also be typed in via the central QWERTY keyboard. It also displays gain level in dBs if the SHOW VALUE function is selected.

### ⑤ Lower Electronic Scribble (6 Character dot display per Fader)

Displays the channel number and any grouping assignment. Displays the channel source name if SHOW VALUE is selected.

### ⑥ ABS and TRM Push-Buttons

Described under Session Management™ (Chapter 7).

### ⑦ Touch Sensitive Fader Knob and Tactile 'Write' Button

Functions described under Session Management™ (Chapter 7).

There are 48 channel faders on the control surface of the OXF-R3, which can control a much greater number of channels using Fader Paging. The SELECT TO FADERS panels, described in the following section, allow any bank of 24 channels to be selected on either side of the centre section at any time.

### Control Grouping

Press and hold **ACCESS** on a central Control Group Fader until it turns amber. Latch **ACCESS** on the channel faders to be slaved. A maximum gain of 10dB can be added to a channel using a Control Group.

Use the same procedure to release slaves except that once the Control Group **ACCESS** has turned amber and its slave **ACCESS** buttons are lit, un-latch the slaves as required.

## 6-2-2 Select to Faders Panel

The following illustration shows the left Select to Faders Panel, which is located immediately to the left of the centre section of the control surface. The right hand Select to Faders Panel, located immediately to the right of the centre section, has a panel layout which is a mirror image of the one described here.

This Panel assigns fader banks to control desired signal paths.

The various push-buttons allow assignment of signal paths to channel faders as per button designation and the previous Fader description. Channel faders may be switched to control:

- **INPUT GAIN** Gain of Mic, M/T and Line
- **M/T SEND** Level sent to M/T bus
- **GROUP TRIM** Gain of M/T Bus Output to M/T Channel
- **M/T MONITOR** Level Sent to Independent M/T Monitor Bus
- **CHANNEL** Channel Level Sent to Main Output Busses
- **SUPER SGs** Levels Sent to Super Send Group Outputs
- **SENDS** Levels Sent to Effects & Foldback Outputs
- **SUB LEVEL** Levels Sent to the Sub Bus in Multi-Format Mode

# 6-2 Channels Section Panels

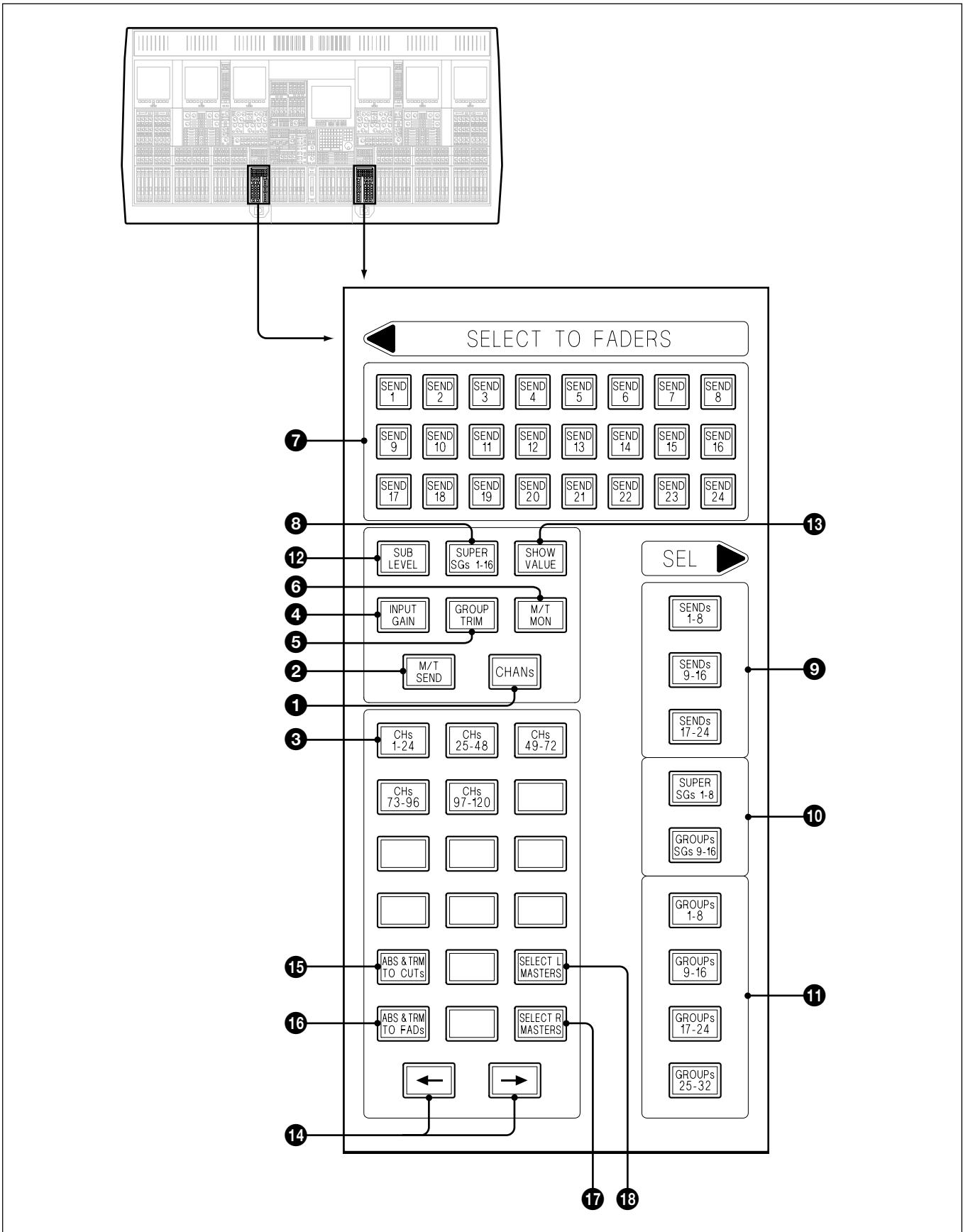

SELECT TO FADERS panel



**❶ CHANS Push-Button (Default)**

Allows faders to be switched to control the level sent to the Main Output busses.

**❷ M/T SEND Push-Button**

Allows faders to be switched to control the level sent to the Multitrack Busses during recording.

**❸ Channel Page Push-Button**

Allows selection of Channel Fader Pages 1-24, 25-48 and so on.

**❹ INPUT GAIN Push-Button**

Allows faders to be switched to control Mic, M/T Return and Line input gain, according to the input source currently selected.

**❺ GROUP TRIM Push-Button**

Allows faders to be switched to control the gain of the M/T bus output to the track on the M/T recorder.

**❻ M/T MON Push-Button**

Allows faders to be switched to control the level sent to the independent M/T monitor bus, for a live mix situation when a multitrack is being recorded in parallel.

**❼ SENDS 1-24 Push-Buttons**

Allow faders to be switched to control the levels sent to effects and foldback busses.

**❽ SUPER SGs 1-16 Push-Buttons (SUPER SEND GROUPS)**

Act as a 'shift' function for the buttons SENDS 1-16 which allow the faders to be switched to control the levels sent to the SUPER SG busses. **(Not operational in this version)**

**❾ SEL Section SENDS 1-8, 9-16, 17-24 Push-Buttons**

Allow the assignment of Send Bus Master Output Levels to be controlled by central multi-purpose master faders.

**❿ SEL Section SUPER SGs 1-8, 9-16 Push-Buttons**

Allow the assignment of SUPER SEND GROUP Output Levels to be controlled by central multi-purpose master faders.

**⓫ SEL Section GROUPs 1-8, 9-16, 17-24, 25-32 Push-Buttons**

Allow Control Groups (equivalent to analogue VCA Groups) to be assigned to central multi-purpose master faders. These Control Groups may be nested.

**⓬ SUB LEVEL Push-Button**

When the MT or Main Output Busses are set up for multi-channel surround sound, this button allows the levels sent to the SUB bass channel to be trimmed using the faders.

## 6-2 Channels Section Panels

---

### 13 SHOW VALUE Push-Button

Allows the display of gain/loss in dB on the upper scribble for the function the fader is presently performing.

### 14 ← & → Push-Buttons

Step the ACCESS button selections one channel at a time in the direction of the arrow.

### 15 ABS & TRM TO CUTS Push-Button

Assigns the **ABS** and **TRM** buttons above the faders to the Cuts.

### 16 ABS & TRM TO FADERS Push-Button

Assigns the **ABS** and **TRM** buttons above the faders to the Faders.

### 17 SELECT R MASTER Push-Button (24-C-0 Control Surface only)

Causes the function selected under SEL in the right hand SELECT TO FADERS panel to be assigned to the right hand 8 centre section faders. This push-button inter-cancels with SELECT L MASTER push-button.

### 18 SELECT L MASTER Push-Button (24-C-0 Control Surface only)

Causes the function selected under SEL in the left hand SELECT TO FADERS panel to be assigned to the left hand 8 centre section faders. This push-button inter-cancels with SELECT R MASTER push-button.

## 6-2-3 Pans Panel

Each of the 6 Pans Panels (3 each side of the control surface) contains 8 definable knobs, with associated electronic dot display, AFL and CUT buttons. Although the primary purpose of these knobs is panning, their functions may be defined. Any pan or gain function may be selected at the SELECT TO PANS panel. Channel SEND/RET(urn) monitor selection, RECORD remotes and ACCESS buttons are also present on this panel.

Use the SELECT TO PANS panel to control:

- **PAN** Left/Right Pan for all occasions where the Fader Output is feeding a Stereo Bus or Front Surround
- **INPUT GAIN** Gain of Mic, M/T Return & Line
- **GROUP TRIM** Gain of M/T Bus Output to M/T channel
- **M/T MON** Level sent to Independent M/T Monitor Bus
- **M/T SEND** Level sent to M/T Bus
- **CHANS** Controls the Level to the Main Output Bus
- **SENDS 1 (-24)** Levels sent to Effects & Foldback Busses.

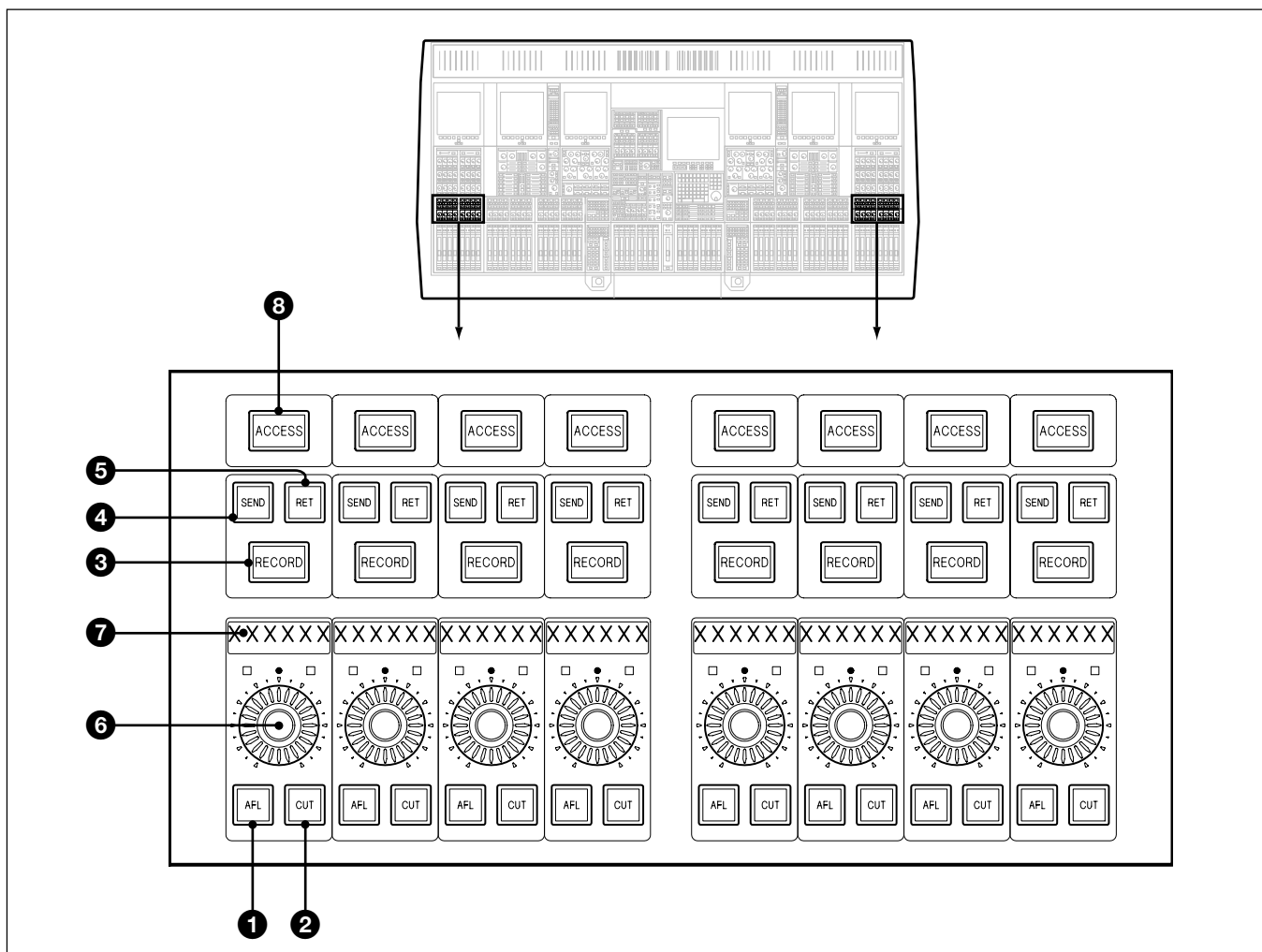

Pans panel

## 6-2 Channels Section Panels

### ❶ AFL Push-Button

Sends AFL signal to monitor LS for whichever level function is assigned to the knob at the time.

### ❷ CUT Push-Button

Mutes the signal assigned to knob. When a pan function is assigned, CUT becomes the pan in/out switch. A pan setting is cleared by CUT.

### ❸ RECORD Push-Button

Switches its related track on multitrack machine into record. (Can be armed only if either its SEND or RET monitor switch has been selected).

### ❹ SEND Push-Button

Selects the channel signal being sent to M/T as monitor source. May be controlled from tape remote master SENDS push-button (see section 6-3-3).

### ❺ RET Push-Button

Selects the return signal being received from M/T as monitor source. May be controlled from tape remote master RET push-button (see section 6-3-3).

#### Note:

*If the associated track is in Record, the monitoring system switches over to the Send signal automatically even though RET is selected.*

#### Note:

*If both SEND and RET are selected, then a mix of both send and return signals becomes the M/T monitor source.*

### ❻ Definable Knob

May be defined to have any gain or pan function depending on what is selected on the SELECT TO PANS panel.

### ❼ Dot Character Display

When SHOW VALUE is selected, the Pan angle of displacement is indicated in degrees. When the knobs are defined as gain controls, the gain value is indicated in dBs.

### ❽ ACCESS Push-Button

Selects the assignable channel area to its associated Channel.

### Using Keyboard Entry to Record Arm Tracks

Press **[RECORD]** at the appropriate machine remotes in the master section. Then use the QWERTY Keyboard: *Specify Channels as Below* **[ENTER]**

- Channels ranges are specified with ‘..’ as a separator:

1..32            = Channels 1-32

- Individual items are separated by ‘.’

2 . 4 . 25       = Channels 2, 4, and 25

- Unlimited strings are possible in the same entry:

e.g. 1 . 3 . 5 .. 08 . 12 .. 42 = Channels 1, 3, 5-8 and 12-42

Press **[RECORD]** **[0]** **[ENTER]** to disarm all the tracks that are armed.

## 6-2-4 Select to Pans Panel

This panel allows assignment of functions to the PAN panels adjacent to it. The default and primary setting is PAN. The options are as follows:

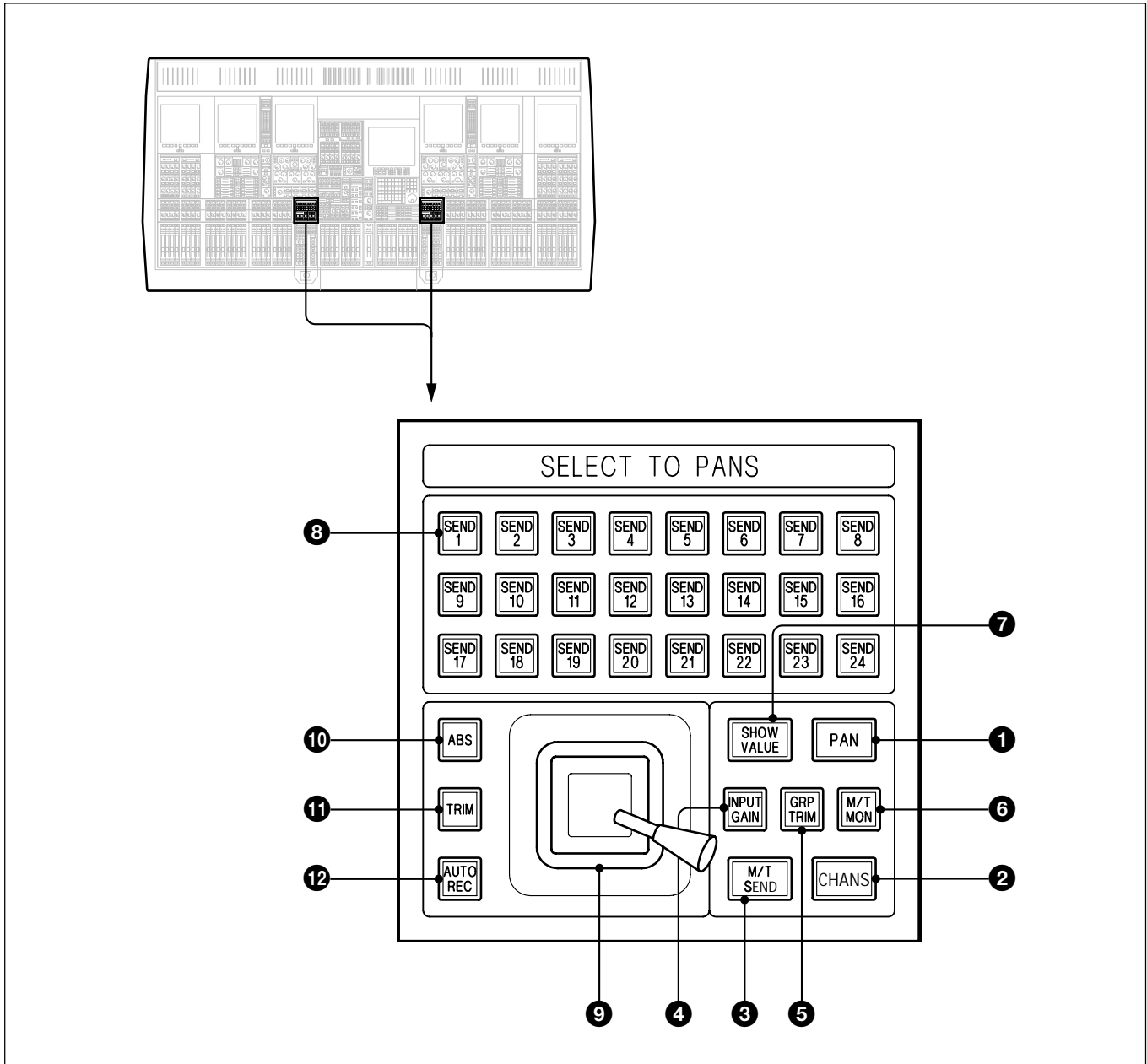

SELECT TO PANS panel

### ❶ PAN Push-Button

Left/Right Pan for all occasions where the Fader Output is feeding a Stereo Bus (default setting).

### ❷ CHANS Push-Button

Allows pans to be switched to control the level sent to the Main Output Busses.

### ③ M/T SEND Push-Button

Allows pans to be switched to control the level sent to M/T bus during recording.

### ④ INPUT GAIN Push-Button

Allows pans to be switched to control gain of Mic, M/T Return and Line Input.

### ⑤ GRP TRIM Push-Button

Allows faders to be switched to control the gain of the M/T bus output to the M/T channel.

### ⑥ M/T MON Push-Button

Allows pans to be switched to control the level sent to the independent M/T Monitor Bus.

### ⑦ SHOW VALUE Push-Button

Allows the display of pan positions in degrees or gain/loss in dB on the pans panel's 6 character dot displays according to the function selected. Press and hold **SHOW VALUE** and the current input device, e.g. ADC183, will be displayed for each individual channel.

#### Note:

*It is the 'raw' input device which will be displayed, not the 'alias' name, if one has been set.*

### ⑧ SENDS 1-24 Push-Buttons

Allow pans to be switched to control the levels sent to the effects and foldback busses.

### ⑨ Joystick

The joystick surround sound panner is in parallel with the M/T Send Pan. It allows 2D surround panning in multi-format mode and left/right pan in stereo mode. Its knob is touch sensitive, indicated by the AUTO REC push-button lighting when touched.

### ⑩ ABS Push-Button

Used to select 'ready absolute' status when automating joystick panning movements (see Chapter 7).

### ⑪ TRIM Push-Button

Used to select 'ready trim' status when automating joystick panning movements (see Chapter 7).

### ⑫ AUTO REC Push-Button

Used to switch the joystick into automation record according to the ABS or TRM status (see Chapter 7).

## 6-2-5 Input and Equaliser Panel

This panel is divided into two distinct sections, the INPUT CHANNEL & INSERTS section and the EQUALISER & FILTERS section, designated A and B respectively in the illustration.

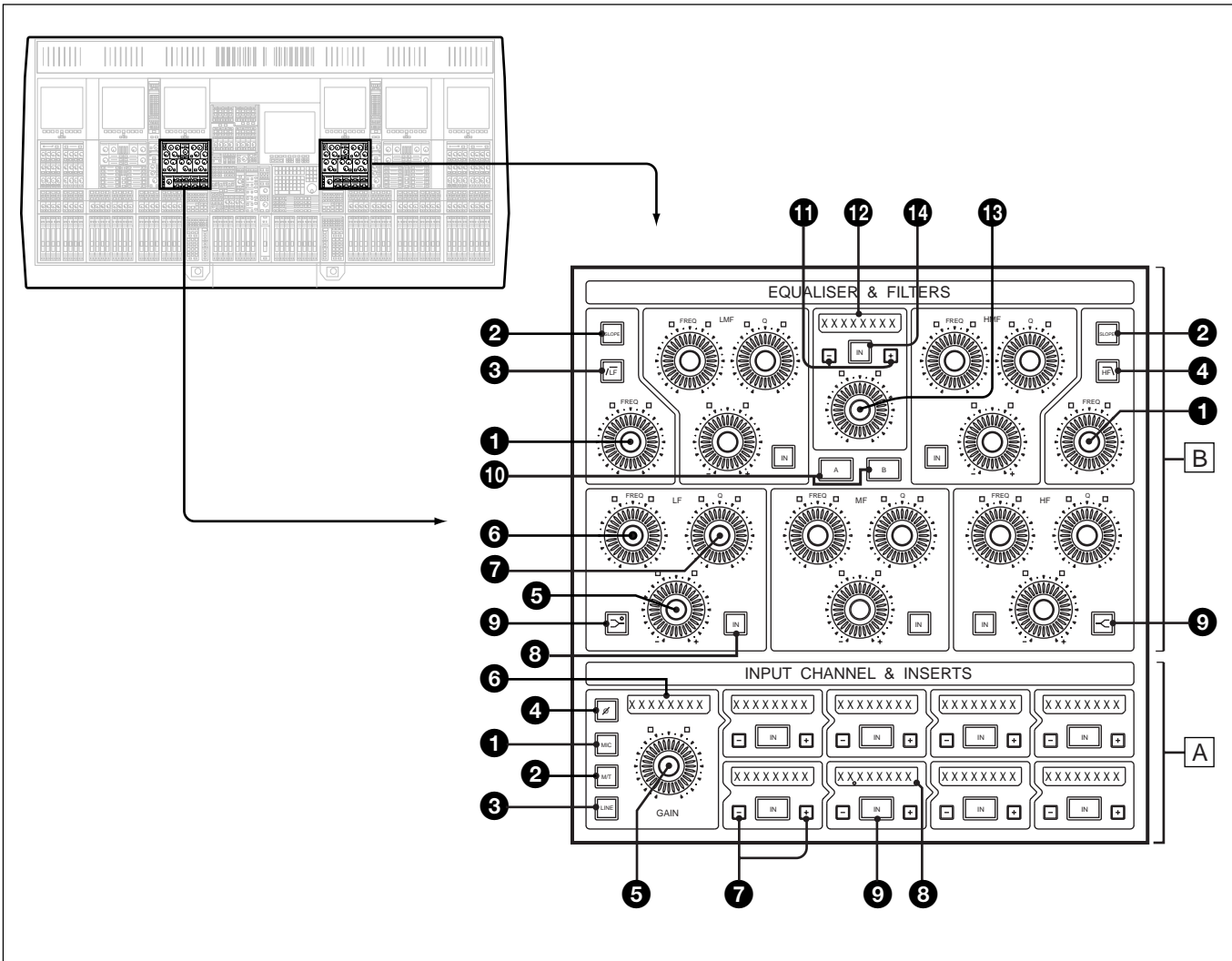

INPUT CHANNEL & INSERTS and EQUALISER & FILTERS panel

### **A** INPUT CHANNEL & INSERTS section

#### **1** MIC Push-Button

Selects the MIC input amp as the source as assigned on the Mic Inputs GUI.

#### **2** M/T Push-button

Selects the digital or analogue M/T return input as assigned on the M/T Return Inputs GUI.

### ③ LINE Push-Button

Selects the digital or analogue LINE input as assigned on the LINE Inputs GUI.

### ④ Ø Push-Button

Reverses phase of the selected input source.

### ⑤ GAIN Knob

Allows gain adjustment for the selected source.

### ⑥ 8 Character Display

Indicates the gain for the current source in dBs.

#### Note:

*The gain and phase settings may be different for all three inputs simultaneously.*

### Channel Path Selectors

The channel signal passes through each selector block from top left to right and then from bottom left to right. Each selector block may have a single process element such as EQ, Insert or Dynamics from the pool available. The sequence of processing may be set up in any order and easily changed according to the task in hand.

### ⑦ +/- Push-Buttons

Select the processor function into position in the signal chain but this will not be inserted and operational until the **IN** button is selected. Step through them until the one required is displayed. Press +/- together to clear display.

### ⑧ 8 Character Display

Indicates processor selection.

### ⑨ IN Push-Button

Puts the process displayed into operation.

#### Note:

*Any processes in use may only be re-ordered or de-selected whilst their IN buttons are not lit i.e. whilst the process is out of the signal path.*

Currently available processes and functions: FILTERS, EQ, DYNAMICS, MULTITRACK, INSERT, DELAY and FADER. The FADER is automatically placed at the end of the bottom right block, at the channel output, unless it is selected in one of the blocks. It need be selected only if, for example, Dynamics is required post fader.

### **B** EQUALISER & FILTERS SECTION

Equaliser and Filter parameters can be displayed on Channel Screens.



## High and Low Pass Filters

### 1 **FREQ Knobs**

Set the turnover frequencies.

### 2 **SLOPE Push-Buttons**

Set dB/Octave 6-36dB in 6dB increments.

### 3 **/ LF Push-Button**

Switches the high pass filter in/out.

### 4 **HF \ Push-Button**

Switches the low pass filter in/out.

## Five Band Equaliser (LF, LMF, MF, HMF & HF)

### 5 **+/- Knobs**

Set the boost or cut levels.

### 6 **FREQ Knobs**

Set the centre frequencies or turnover frequencies for shelf curves.

### 7 **Q Knobs**

Set the bandwidth of EQ curves.

### 8 **IN Push-Buttons**

Allow individual EQ sections to be switched in/out.

### 9 **& (LF & HF) Push-Buttons**

Select shelving curves for high and low sections.

When LF or HF are in shelf mode, their 'Q' knobs control overshoot.

### 10 **A & B Push-Buttons**

Two complete EQ (but not Filter) settings may exist simultaneously. The A and B buttons allow toggling between them for comparison purposes.

### 11 **+/- Push-Buttons**

Select the functions for the EQ definable knob and **IN** button.

### 12 **8 Character Display**

Displays the function type selected using the **+** / **-** buttons **11**.

### 13 **Definable Knob**

Used to adjust or further select options set according to the **+** / **-** buttons **11**.

### 14 **IN Push-button**

Switches in options set according to the **+** / **-** buttons **11** and the EQ definable knob.

## 6-2 Channels Section Panels

### 6-2-6 Free Assign Area & Dynamics Panel

This Panel allows control of Dynamics and Delay functions and is designed such that future additional option processing elements may easily be accommodated.

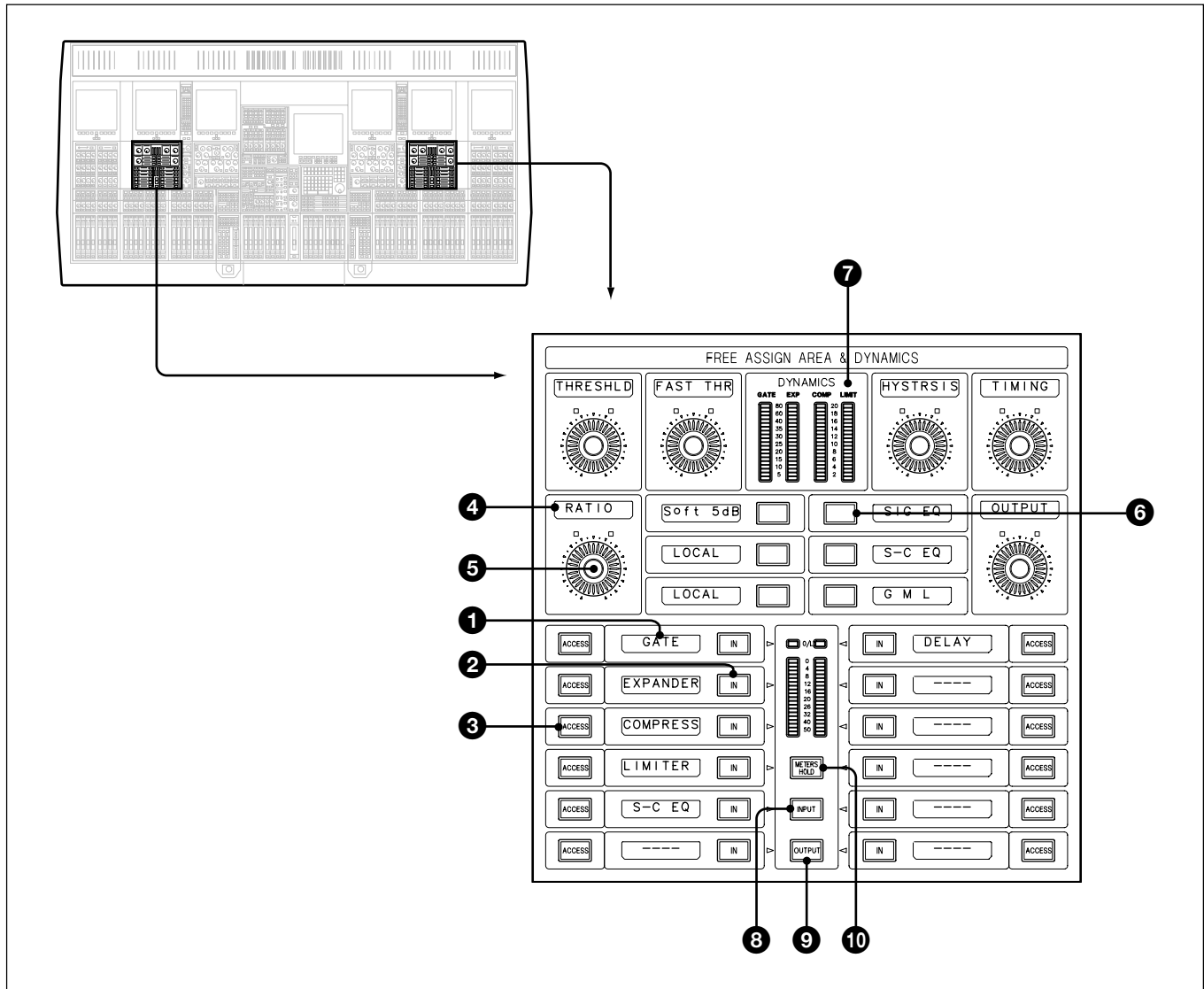

FREE ASSIGN AREA & DYNAMICS panel

#### 12 x Selector Blocks (Lower Left & Right)

These selectors display, and allow selection of, available processing elements which may be accessed in the channel path selectors on the Input Channel & Inserts panel section.

#### 1 8 Character Displays

Indicate the processing elements available.

#### 2 IN Push-Button(s)

Puts its displayed process element into operation.

**3 ACCESS Push-Button(s)**

Allows Free Assign controls to access control of selected process.

**Note:**

*Selecting any IN button selects its associated ACCESS automatically.*

**6 Definable Knobs and 6 Switches****4 8 Character Displays**

Indicate the functions of adjacent definable knobs and switches.

**5 DEFINABLE Knobs**

Allow adjustment of parameter indicated.

**6 Push-Buttons**

Allow switched function as indicated.

**7 Dynamics Meters**

4 x 20 segment meters indicate gain reduction within the Dynamics section for the GATE, EXPANDER, COMPRESSOR and LIMITER functions. Back-lit legends above each meter indicate which particular Dynamics sections are switched into the signal path.

The IN button below the window selected to DYN on the Input Channel & Inserts section can be used as a master in/out switch for the whole dynamics section.

**Stereo Meter [Lower centre] (Not operational in this version)**

The two meters between the two columns of IN buttons indicate audio levels within the process currently accessed. A back-lit arrow will point to the appropriate IN button. The Meter switch functions are as follows:

**8 INPUT Push-Button**

Switches the meter to read the input of the accessed process.

**9 OUTPUT Push-Button**

Switches the meter to the process output.

**10 METERS HOLD Push-Button**

Fixes the meter to the process accessed at the time. Once selected, the meters will not follow further access functions until METERS HOLD is released.

### The Dynamics Area

- **GATE**
- **EXPANDER**
- **COMPRESSOR**
- **LIMITER**
- **SIDE-CHAIN EQUALISER**

The names of these functions appear in small display windows on the panel. By pressing the **ACCESS** button to one side of the window, control of that function is assigned to the six knobs at the top of the panel.

The following diagram shows an example in which the **ACCESS** button has been pressed for the **GATE** and its controls are now available on the panel. It can be switched in and out of circuit by pressing the **IN** button. The diagram also shows how, as each **ACCESS** button is pressed, the Free Assign area of the panel is assigned to the function selected.

By switching between **ACCESS** buttons, the six knobs are being paged to control the different functions which are being accessed.

A dynamics page is available on the channel screens displaying the settings for each process and a graphical representation of the processing on that signal.

The **IN** button below the window selected to **DYN** on the Input Channel & Inserts section can be used as a master in/out switch for the whole dynamics section.

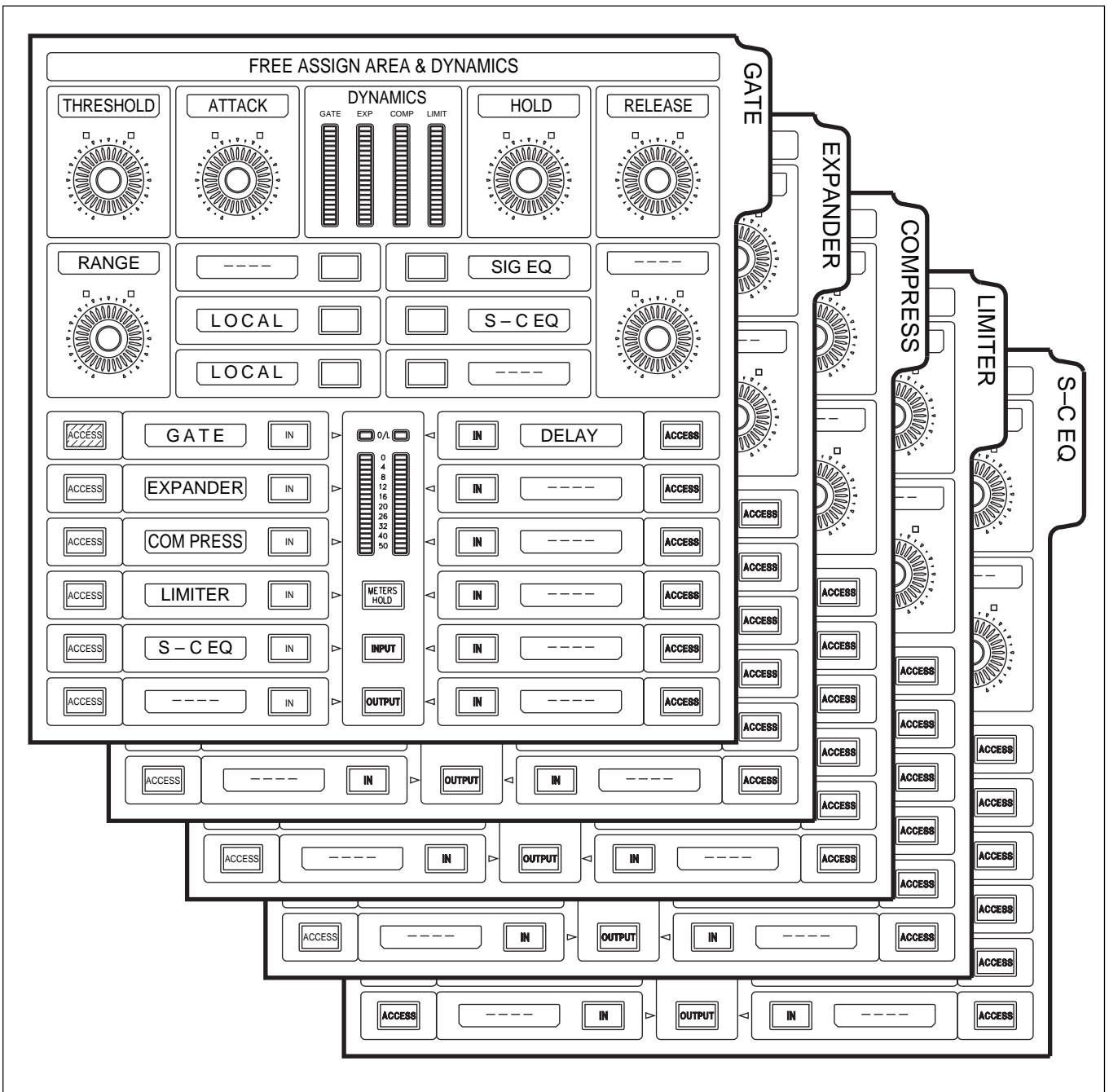

FREE ASSIGN AREA 'virtual panels' illustration

## 6-2 Channels Section Panels

### Dynamics Side-Chain Equaliser

The Side-Chain EQ is a two-band parametric covering a bandwidth from 20Hz to 20kHz. It can be used as an additional EQ in the signal path as well as the Dynamics Side-Chain.

Select the **ACCESS** button by the window displaying S-C EQ and the knobs and switches will be assigned to the Side-Chain EQ. Select its **IN** button.

The assignable buttons allow two selections, SIG EQ and S-C EQ, as illustrated in the following diagram. They work as follows:

- Select **SIG EQ** to have the equaliser affect the signal path alone.
- Select **S-C EQ** to insert the equaliser in the Dynamics Side-Chain alone.
- Select **both SIG EQ and S-C EQ** to affect the signal path and dynamics side-chain.

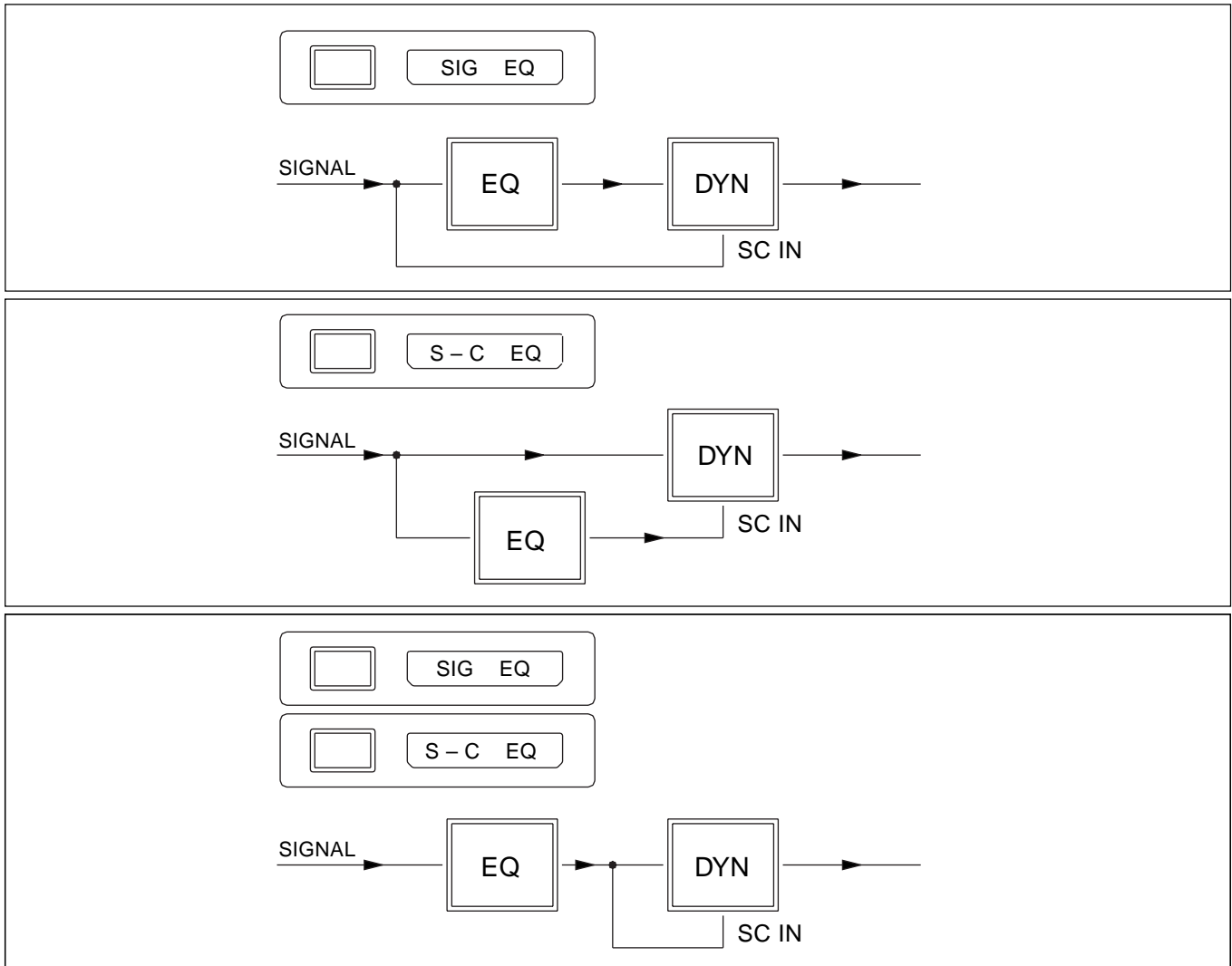

Side-chain EQ settings

## 6-2-7 Multitrack Panel

This panel allows control of all Multitrack functions, apart from track routing assignments, for the channel currently accessed.

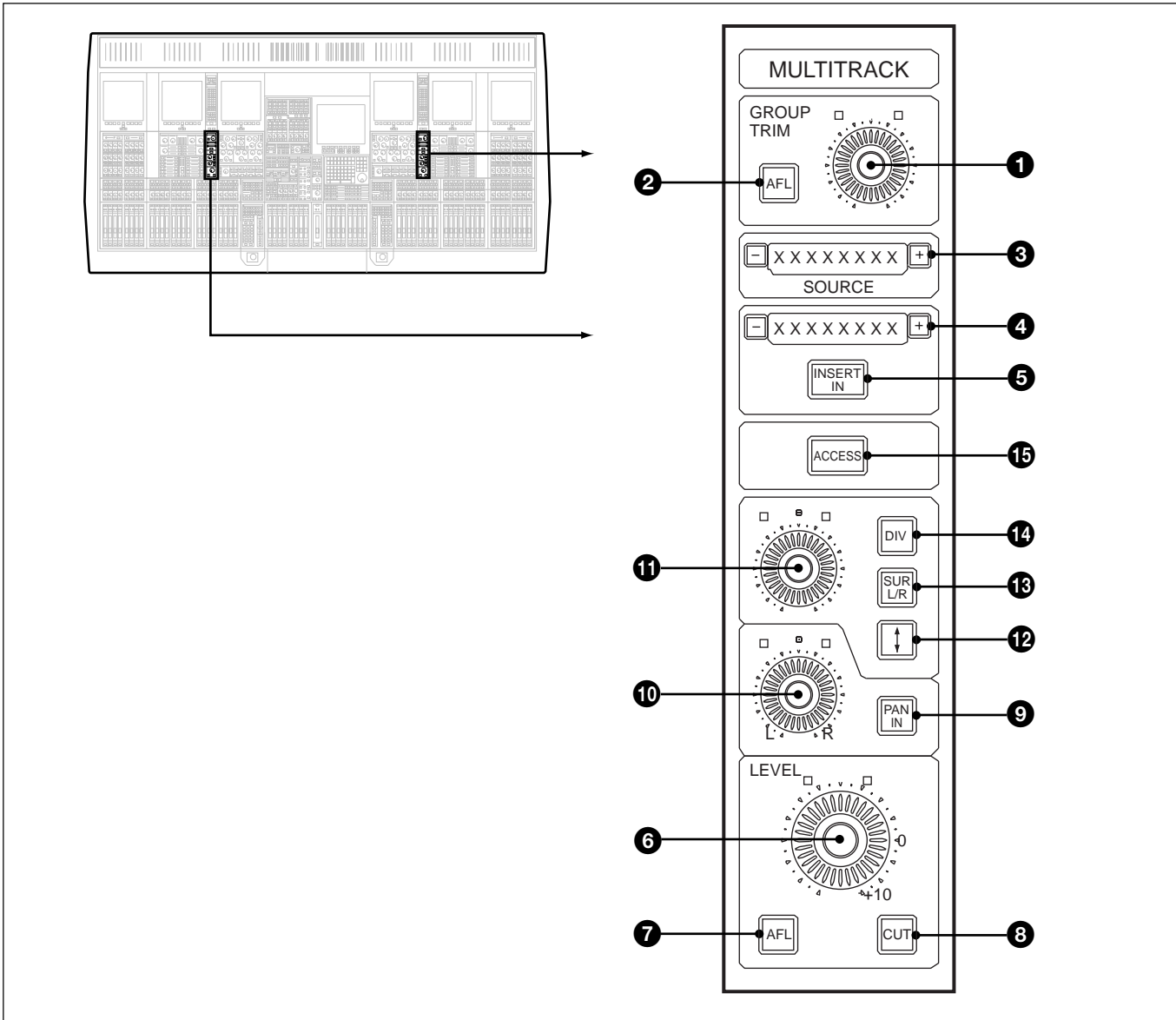

MULTITRACK panel

### GROUP TRIM section

#### 1 GROUP TRIM Knob

Controls gain of the M/T bus output to M/T channel.

#### 2 AFL Push-Button

Sends post Group Trim signal to monitor LS.

### SOURCE section

#### 3 Character Display

Indicates signal source point in channel chain from where the signal to feed the Multitrack is derived.

+/- Push-buttons allow selection of the junction in channel path from where the Multitrack signal is sourced. The signal will be taken directly from the output of the function displayed.

**Note:**

*Operable only if the IN button for the Multitrack (displayed as MULTI) is not selected on the Input Channel & Inserts panel.*

### INSERT section

#### 4 +/- Push-Buttons (Not operational in this version)

Allow the list of insertable devices to be displayed, one at a time, on the 8 character display.

#### 5 INSERT IN Push-Button

Inserts the device selected via the I/O GUI (see Chapter 5).

**Note:**

*It is not possible to change insert selection when the INSERT IN is selected.*

### Multitrack LEVEL and Pan section

#### 6 LEVEL Knob

Controls the level of signal being sent to the M/T routing bus switching.

#### 7 AFL Push-Button

Sends the signal post the M/T Level to monitor LS.

#### 8 CUT Push-Button

Mutes the signal post M/T Level control.

#### 9 PAN IN Push-Button

Switches in the Pan functionality according to format selected (Stereo or Multi-Format selected in the centre section). For stereo panning, at least one odd and one even track must be selected in the Multitrack routing section.

#### 10 L/R PAN Knob

Allows left/right panning.



---

**11 Definable Knob**

Works in conjunction with the front/back, the surround left/right and divergence panning if a multi-format mode has been selected.

**12 Back/Front Push-Button**

Assigns the definable knob to back/front panning.

**13 SUR L/R Push-Button**

Assigns definable knob to rear surround left/right panning.

**14 DIV Push-Button**

Assigns the definable knob to control of divergence.

**15 ACCESS Push-Button** (Not operational in this version)

Allows process elements in the multitrack signal path to be accessed.



## 6-2 Channels Section Panels

### 6-2-8 Routing Panel

The Routing panels allow signals to be routed to Multitrack busses, the Main Output Bus and the Super Send Groups. Multi-Format routing and its monitor are also set using this panel.

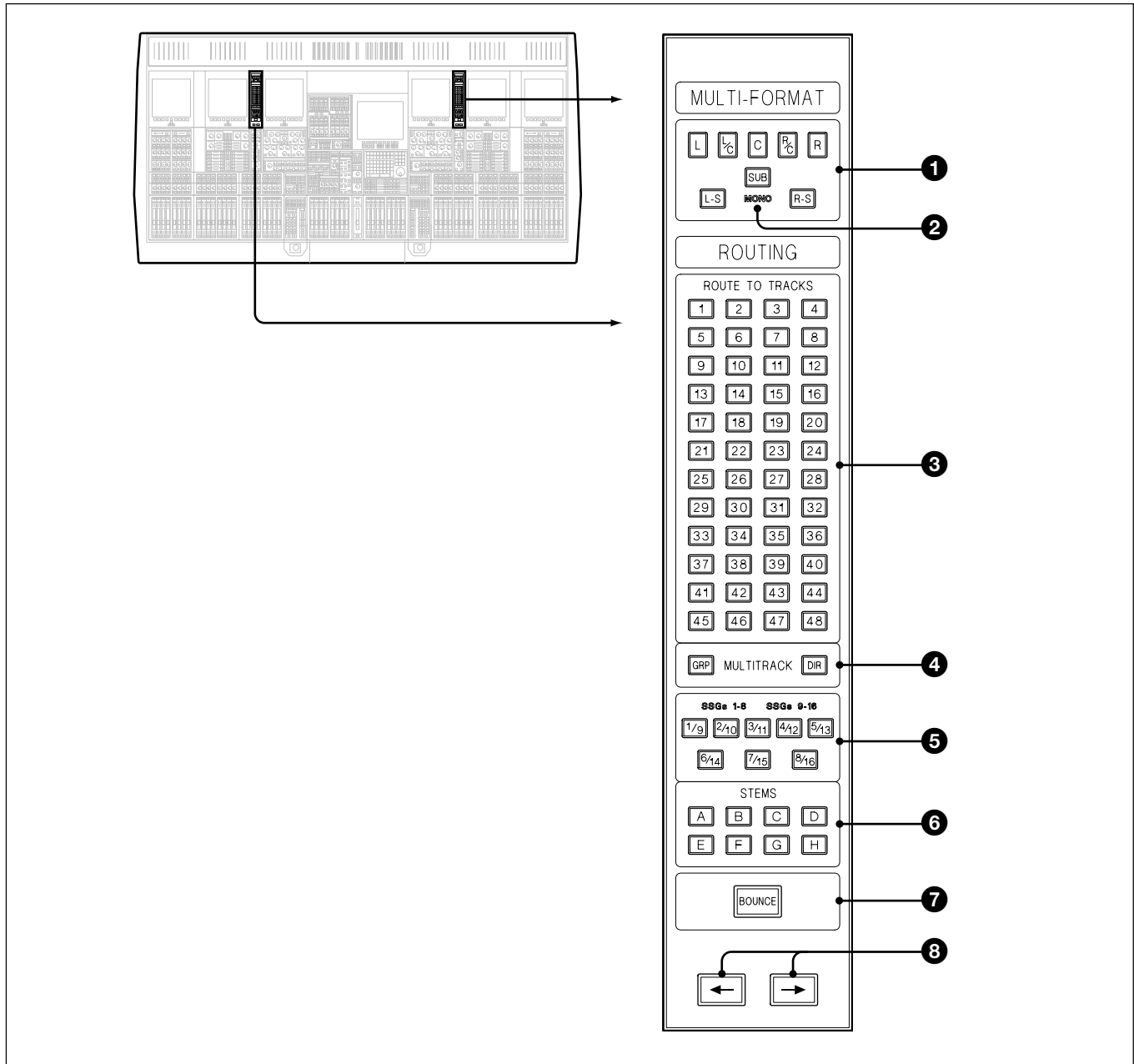

ROUTING panel

#### MULTI-FORMAT Section

**1 MULTI-FORMAT L, L/C, C, R/C, R, L-S, SUB, R-S Push-Buttons**  
These allow surround routing for a number of sources. Their function is set depending on which function is selected to the faders in the channels section.

The button layout mimics the Multi-Format LS set-up for easy recognition when routing Multi-Channel sources. With this scheme it is not necessary to remember track numbers.

### Channel Faders

If **CHANS** is selected on the SELECT TO FADERS panel, then the surround routing buttons assign the Channel Output signal (post the Channel Pan) to the the Main Bus according to the format selected for the Main Bus: Stereo, LCRS, 5.1 or 7.1.

### Multitrack Send Faders

The surround routing buttons are operational for Multitrack Sends if Stems have been set up. In this case, if **M/T SEND** is selected on the SELECT TO FADERS panel, the surround routing buttons assign the Multitrack Send Fader Output signal (post M/T Pan) to those Multitrack Busses, according to the current Stem. See **6** below.

When a surround routing button is selected, the related track button, one of 1-48, is selected automatically and also lights.  
(See Chapter 4 for details of Stem Set-up)

#### Note:

*The above applies only for Multitrack Surround modes and does not apply when the Multitrack Busses are set for stereo use.*

### 2 MONO Legend

Illuminates if the format selected has mono rear surround.

## ROUTE TO TRACKS Section

### 31- 48 Push-Buttons

This matrix is used to select which M/T busses are fed from channel M/T output.

### 4 GRP (Group) & DIR (Direct) Push-Buttons

GRP (fire-up default) sends the Group Mix Bus output to the Multitrack 1 MADI Output (SP-Link 2 Loop 0) for any routing button selected for the currently accessed channel. DIR sends the direct M/T Fader output signal to Multitrack 1 MADI Output. Group Outputs 1-48 will continue to feed Multitrack 2 MADI Output (SP-Link 2 Loop 1). DIR selected on any channels from 49-96 will cause their direct M/T Fader output signals to feed Multitrack 2 MADI Output in place of any of the Groups 1-48. For example DIR and button 1 selected on channel 49 will replace the Group 1 signal with the M/T Fader signal from channel 49. In other words this allows any combination of Group or Direct signals to Multitrack MADI Outputs 1 and 2.

#### Note:

*Normal M/T Monitoring is available only for M/T Groups 1-48. M/T Fader AFL must be used to listen to Direct Output Sends.*

### Super Send Group O/Ps

#### 5/9 – 8/16 Push-Buttons

Allow the channel output signal, i.e. the same signal that routes to the Main Output Bus, to be routed to the Super Send Group outputs. The “width” of an SSG can be different to that of the Main Output Bus. As an example, the Main could be operating with a 5.1 output whereas an SSG could be set up as:

- Stereo
- LCR
- LCRS
- 5.0
- 5.1
- 7.0
- 7.1

SSGs 1-8 back-lit legend indicates that the buttons will operate for SSGs 1-8. This means that the **SUPER SGs 1-8** button has been selected in the centre section.

SSGs 9-16 back-lit legend indicates that the buttons will operate for SSGs 9-16. This means that the **SUPER SGs 9-16** button has been selected in the centre section.

#### 6 A-H Push-Buttons (Stems)

Inter-cancelling buttons that select which stem is fed according to the settings of the Multi-Format routing buttons 1

#### 7 BOUNCE Push-Button

Re-directs the channel output from the Main Output Bus to the Multitrack Busses. For a ‘bounce-down’, select **BOUNCE** and then, depending on whether the Main Output Bus is set to Stereo or a Surround Mode:

##### • Stereo

In the ROUTE TO TRACKS section, select from routing buttons 1-48 accordingly. Odd numbered buttons will assign the L output of channels and even will assign the R output.

##### • Surround

In this case the channel outputs can only be bounced to Stems which are already set up. Select a Stem button, one of A–H. Then make assignments using the the surround buttons at the top of the Routing panel in the MULTI-FORMAT section.

The level and pan settings are retained, making this operation extremely easy and convenient.

### Access Function

#### 8 ← & → Push-Buttons

Are linked to the channel ACCESS buttons and are used to move the channel Access assignment left or right across the channels. A highlighted area within the appropriate LCD channel control screens reflects any change in assignment, highlighting relevant information such as routing set-up, for example.

## 6-2-9 LCD Channel Screen Panel

Three LCD Channel Screens are provided in each channels section of the OXF-R3 control surface. Each panel contains a 10.4 inch colour TFT LCD VGA screen for displaying channel input and output routing, EQ and dynamics transfer curve and parameters.

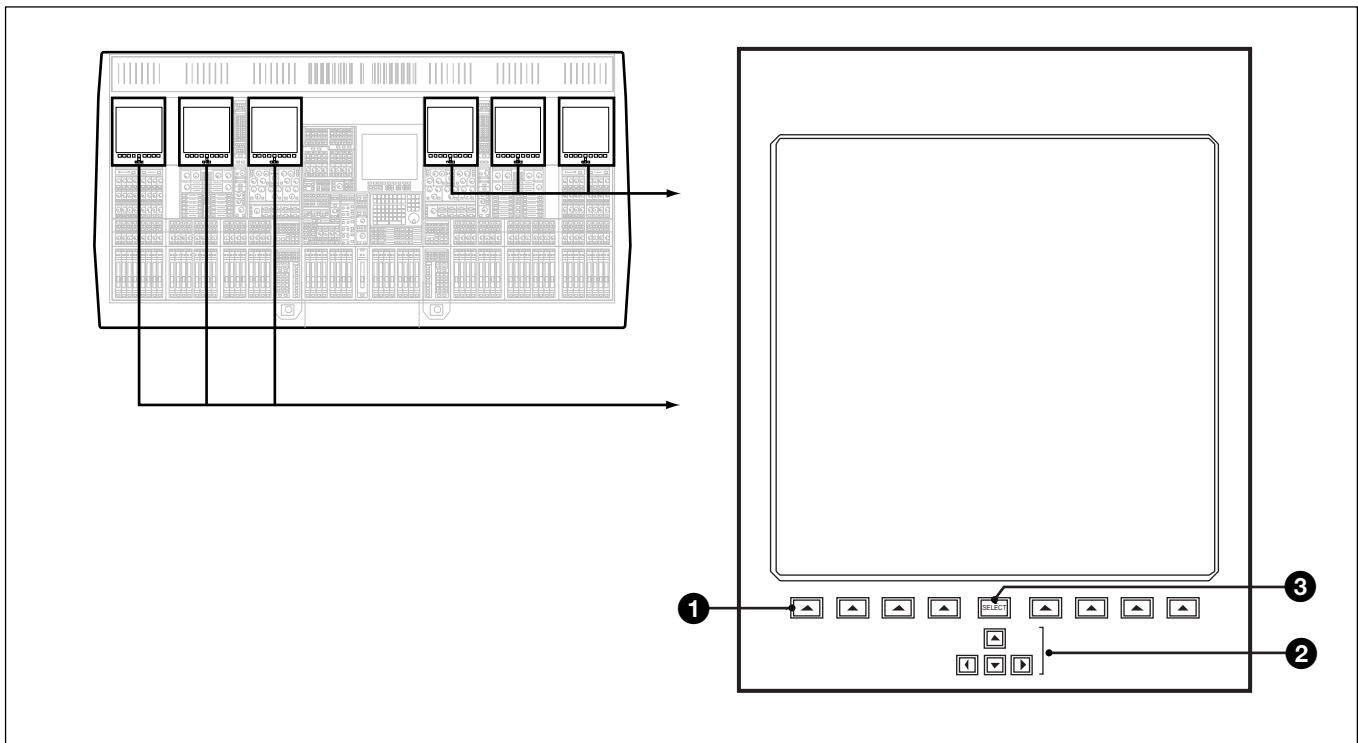

LCD Channel Screen panel

### ❶▲ (x 8) Push-Buttons

Select screen pages as indicated by labels within the screen above each button.

### ❷◀ ▲ ▼ ▶ Push-Buttons

Allow page selection within sub-divisions of screen pages (see Chapter 3 for details).

### ❸SELECT Push-Button

Selects the cursor to the centre of the LCD screen.

## 6-2 Channels Section Panels

### 6-2-10 Sends 1-24 Panel

This panel contains a Level control and an ON button for each Send and allows control of the signals sent from the channel currently accessed. The source point can be set individually for each Send.

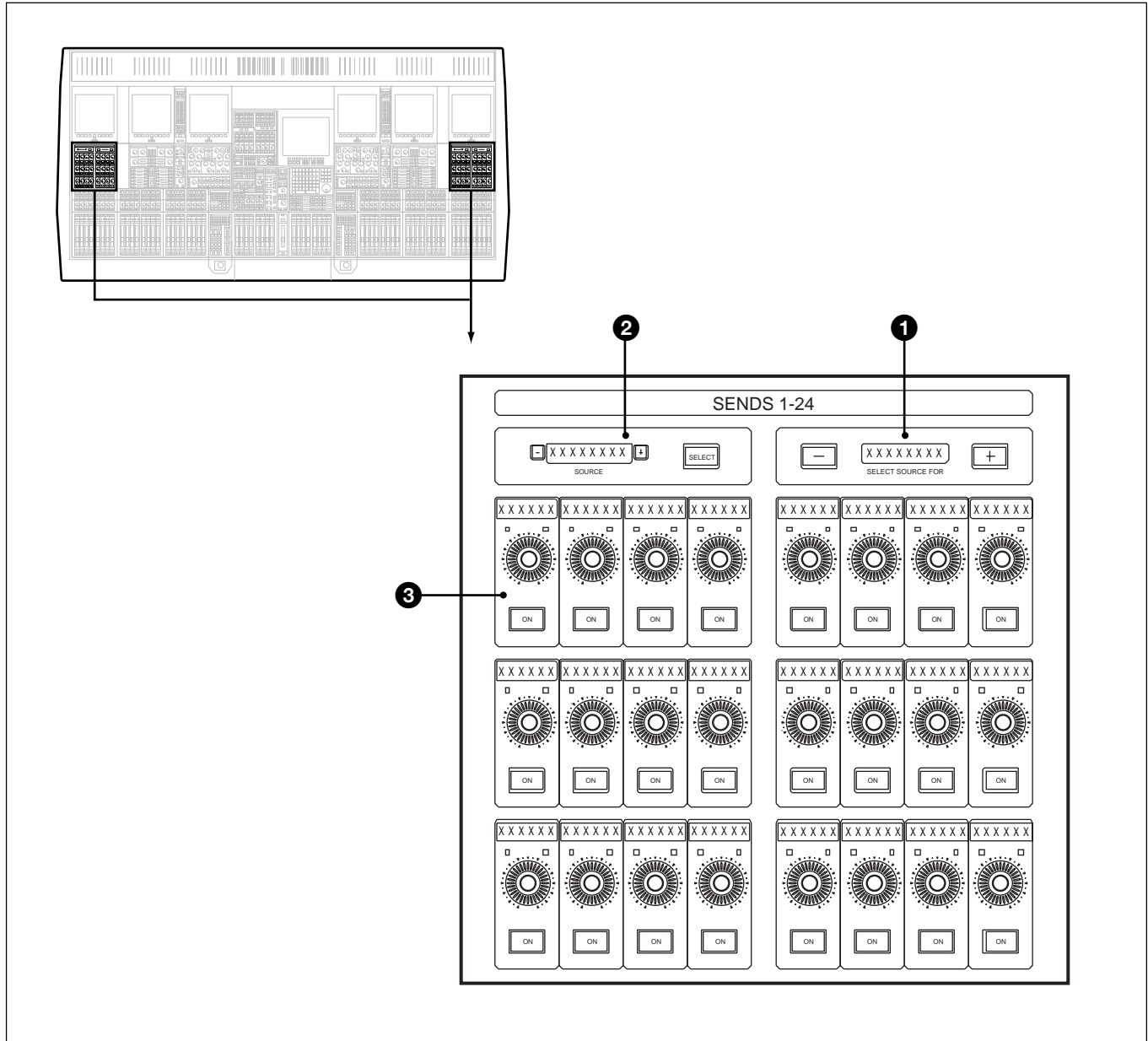

SENDS 1-24 panel

#### 1 Bus Access Push-Buttons

The + and - Push-buttons (large rectangular type) allow access to each bus in turn in order to allow source point selection for each Send individually.

The 8 character display indicates the bus number or name.

## 2 SOURCE Selection Push-Buttons

The + and - Push-buttons (small square type) allow the source points within the channel signal path to be viewed one at a time on the 8 character display, by stepping through them.

The **[SELECT]** Push-button allows selection of the Source point displayed for the Send bus indicated in ❶ The signal will always be sourced from a point directly after the process displayed.

### Note:

*The **[SELECT]** button will illuminate as a warning as soon as a different source from the current one is displayed in the SOURCE window. In other words, once lit, the source point will change if it is pushed. Then its light will go out.*

## Global selection

Selecting the Main L/R fader **[ACCESS]** before pressing the Send Source **[SELECT]**, will cause the Source point to be selected on all channels.

## 3 Send Bus Levels and ON Push-Buttons

Each knob controls the level to its bus with a range from infinity (completely off) to +10dB of gain. Its associated **[ON]** push-button allows preset Send levels to be switched on and off. The 6 character display above each Level knob and **[ON]** switch pair indicates the bus number or name accordingly.

Each odd/even pair of Sends can be linked to form a Stereo Send bus. This is achieved at the Send Outputs panel in the centre section by selecting the **[STER](eo)** button between the odd/even pair of Sends to be linked. In this case, on the panels in the channel areas, the odd numbered knob is retained as a level control whilst the even numbered knob becomes a left/right pan.

All Send settings are displayed simultaneously for a single channel at this panel. The balance for any single Send bus can be achieved by assigning that Send bus to the Faders or Definable Knobs (Pans by default). See the Select to Faders panel description (section 6-2-2) or the Select to Pans panel description (section 6-2-4).

## 6-2 Channels Section Panels

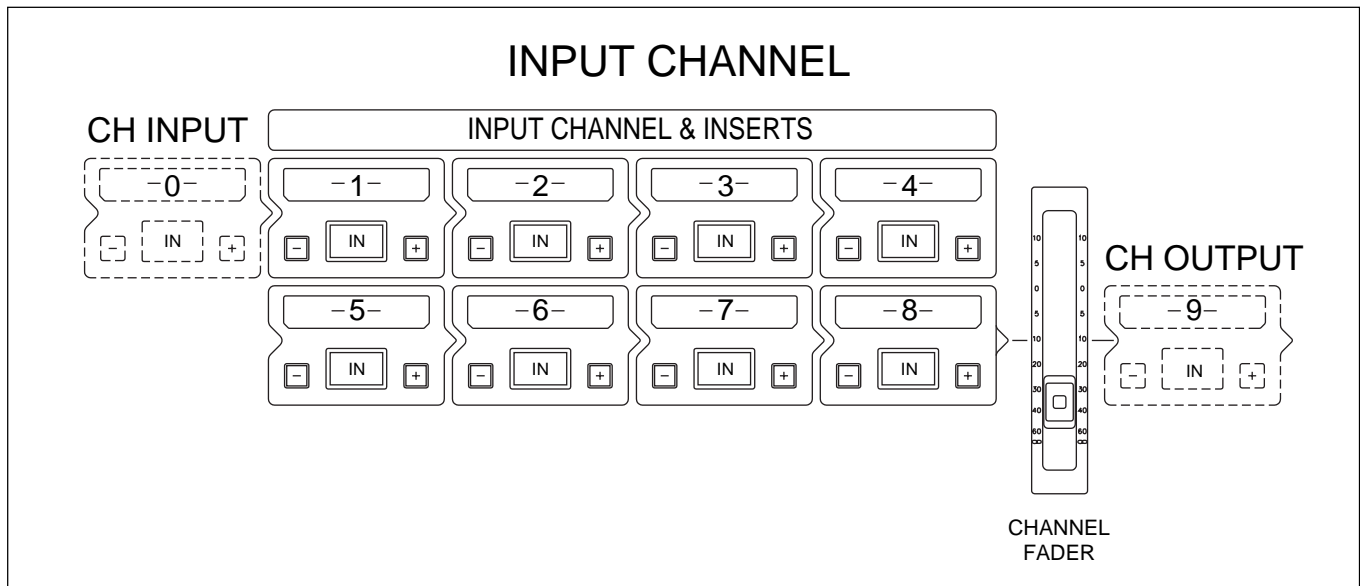

Source point options for Sends

### Input channel source points for the Sends in detail

This diagram illustrates the channel path as laid out at the Input Channel & Inserts panel. Source points may be taken from after any of the processing block windows, 1-8, as well as before the first block, and after the last one, post the channel fader. The diagram shows the extra source points as imaginary windows within the channel path. The Source point pre window -1- will be displayed as CH INPUT, which takes a totally clean signal from post the input gain stage. The Source post fader is labelled C OUTPUT as displayed on the 8 character display in the SOURCE selector area.

### M/T Send Fader source point for Sends

A further option as a source point for Sends, is the signal post the M/T Send Fader. This is indicated by MT SEND in the Source display (see page 6-37 for more details).



### Pre Fader headphones feed

The example below illustrates an in-line channel set up at the Input Channel & Inserts panel. The right hand window in the Sends panel has Send 1 selected. The left hand window shows the source as -8- for Send 1. The block schematic illustrates how this set-up is equivalent to a pre fader send on a conventional in-line console, useful for headphone feeds to Foldback outputs.

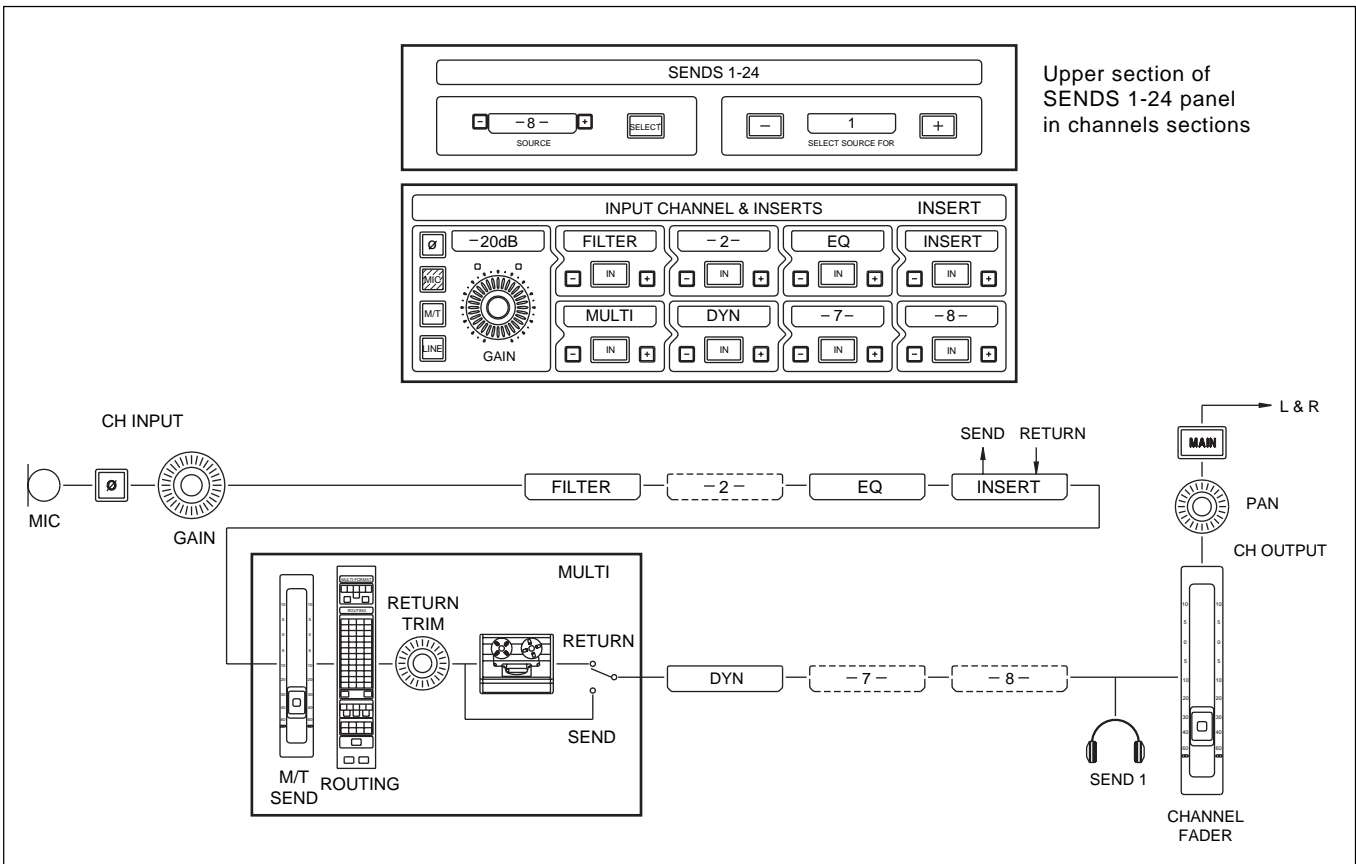

Upper section of SENDS 1-24 panel in channels sections

Send 1 - Pre Fader headphones feed for Foldback

## 6-2 Channels Section Panels

### Post Fader headphones feed

To change the previous set-up to post fader, simply toggle the SOURCE window to C OUTPUT. The **SELECT** will light, indicating that a new selection is available. Press it to invoke the new source point.

This action rearranges the schematic as in the illustration below.

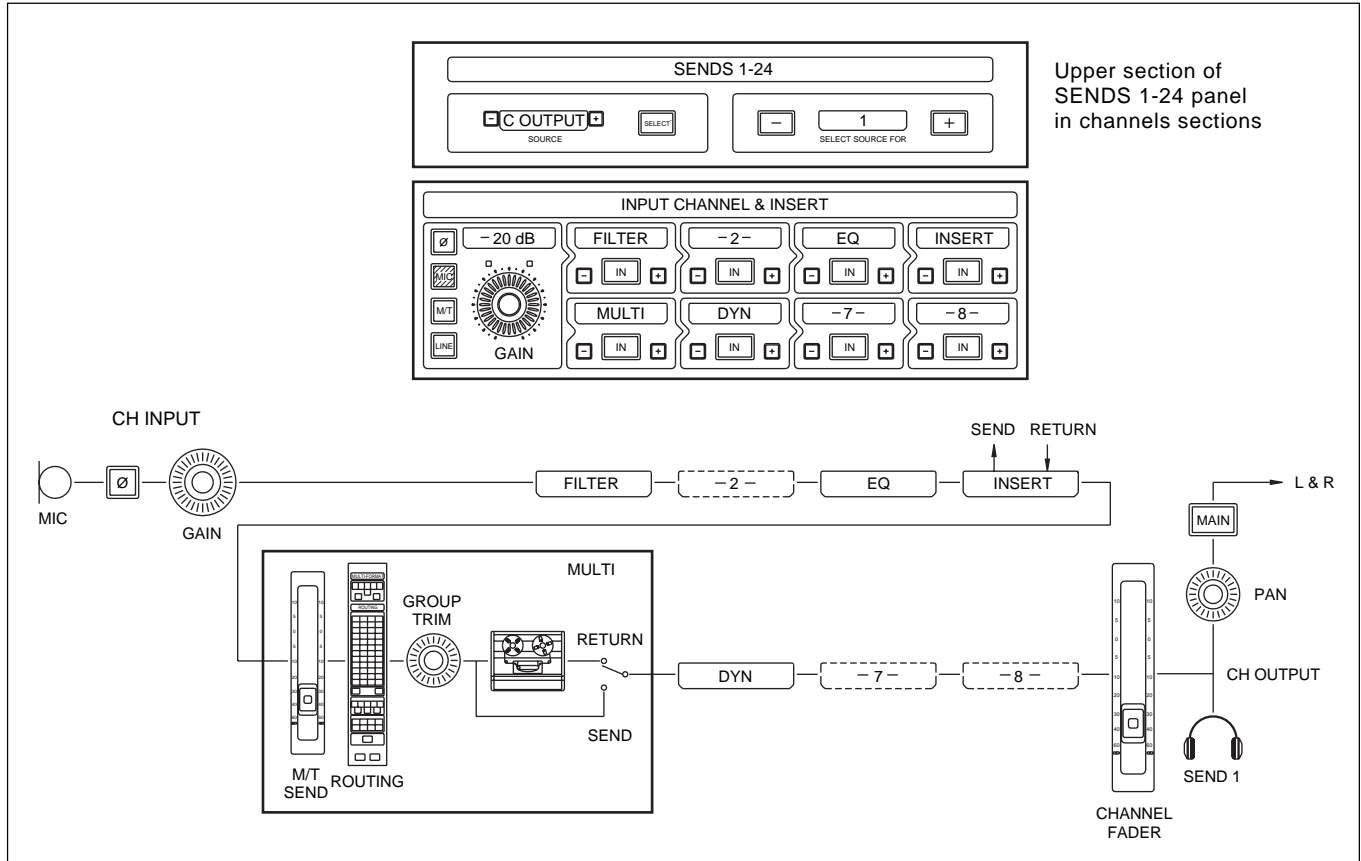

## Post M/T Send Fader headphones feed

To change the previous set-up to post multitrack send fader, simply toggle the SOURCE window to MTSEND. The **SELECT** will light indicating a new selection is available. Press it to invoke the new source point.

This action rearranges the schematic as per the illustration below.

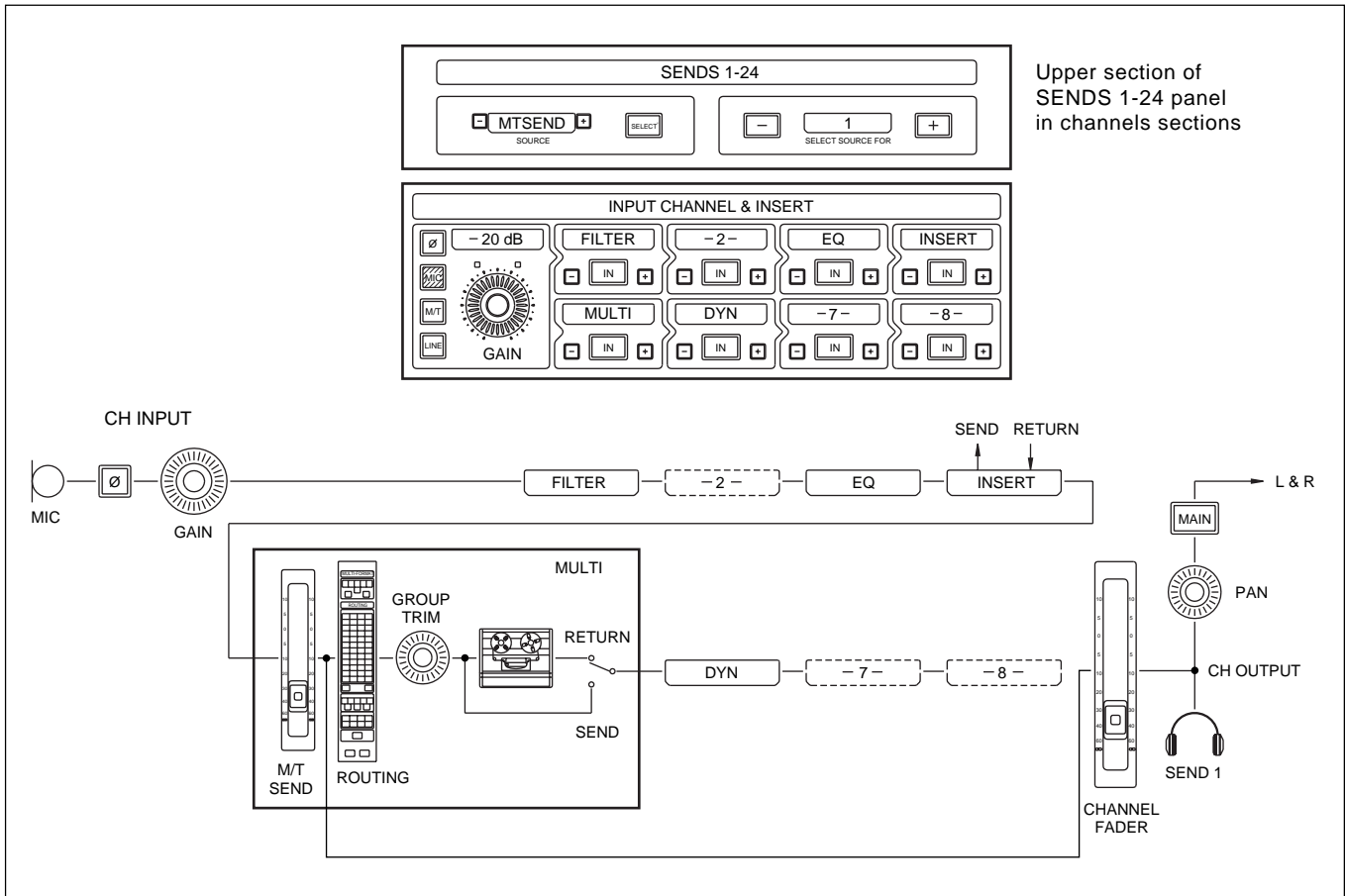

Send 1 - Post M/T Send Fader headphones feed

This flexible set-up procedure allows each Send to be sourced from any point in the channel signal path. Once a useful set-up has been created, it can be copied to other channels or saved in a Snapshot to be recalled later.

Procedures for these functions are described in Chapter 7.

# 6-3 Central Section Panels

## 6-3-1 Master Fader Panel

The Master Fader panel contains a linear, touch sensitive motorised fader with associated electronic dot character scribble display and local dynamic automation controls. This centrally placed master fader controls the level of the MAIN Stereo Output bus.

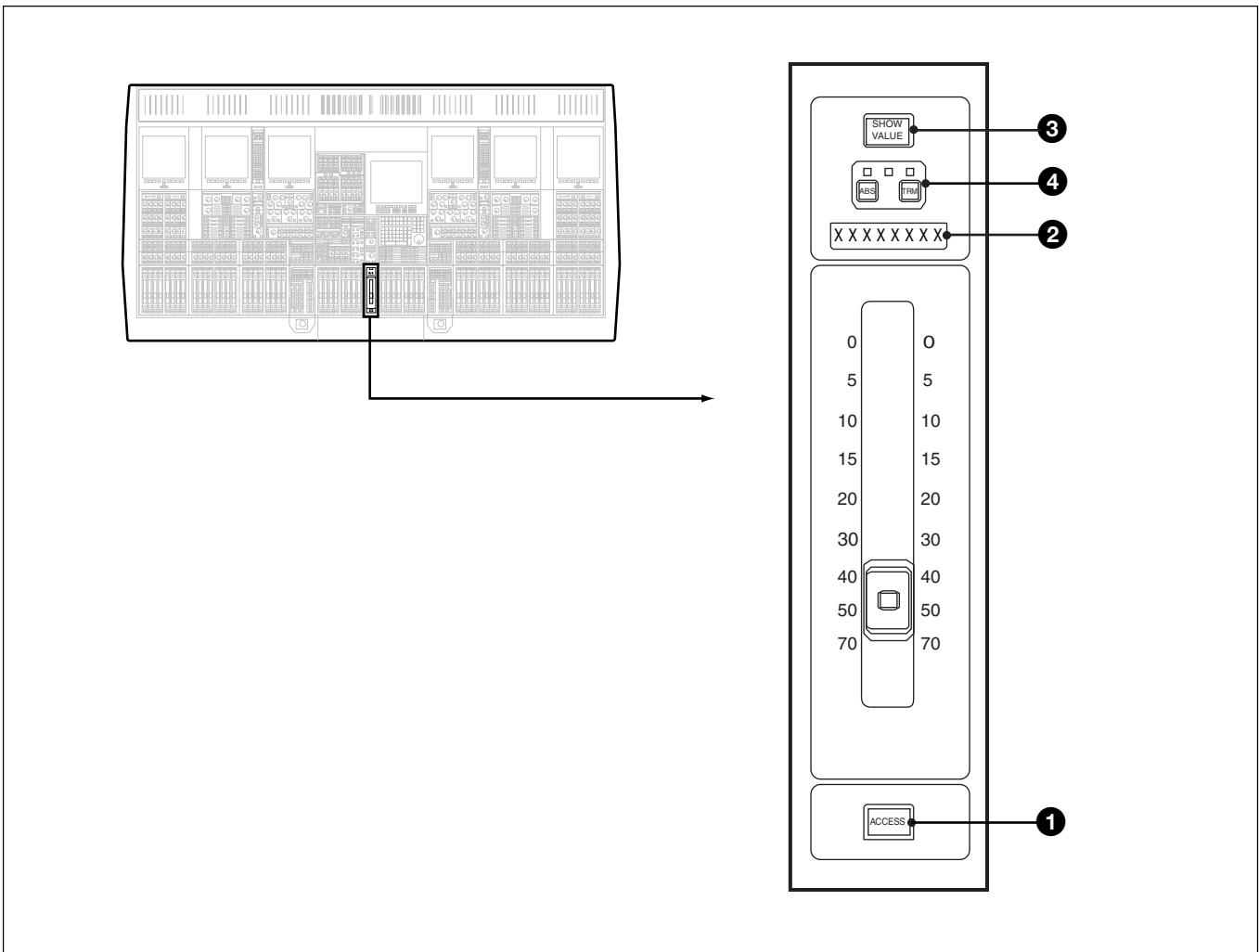

### 1 ACCESS Push-Button

Allows access to an Insert, full featured Stereo Compressor and 2 band EQ to the Main Output Bus. The controls for these functions are accessed using **CEN ACCS L** and **CEN ACCS R** buttons on the Monitor panel.

### 2 8 Character Display

Displays the Main Output Bus active format - Stereo, LCRS, 5.1 or 7.1

### 3 SHOW VALUE Push-Button

Allows the display of Master Fader gain/loss in dBs on the 8 character display. It switches on this function for all Centre Section Faders.

### 4 Automation Buttons (Described in Chapter 7)

## 6-3-2 Monitor Panel

This panel contains all the monitoring, foldback, metering and communications functions for the OXF-R3 control surface, together with a number of central control functions.

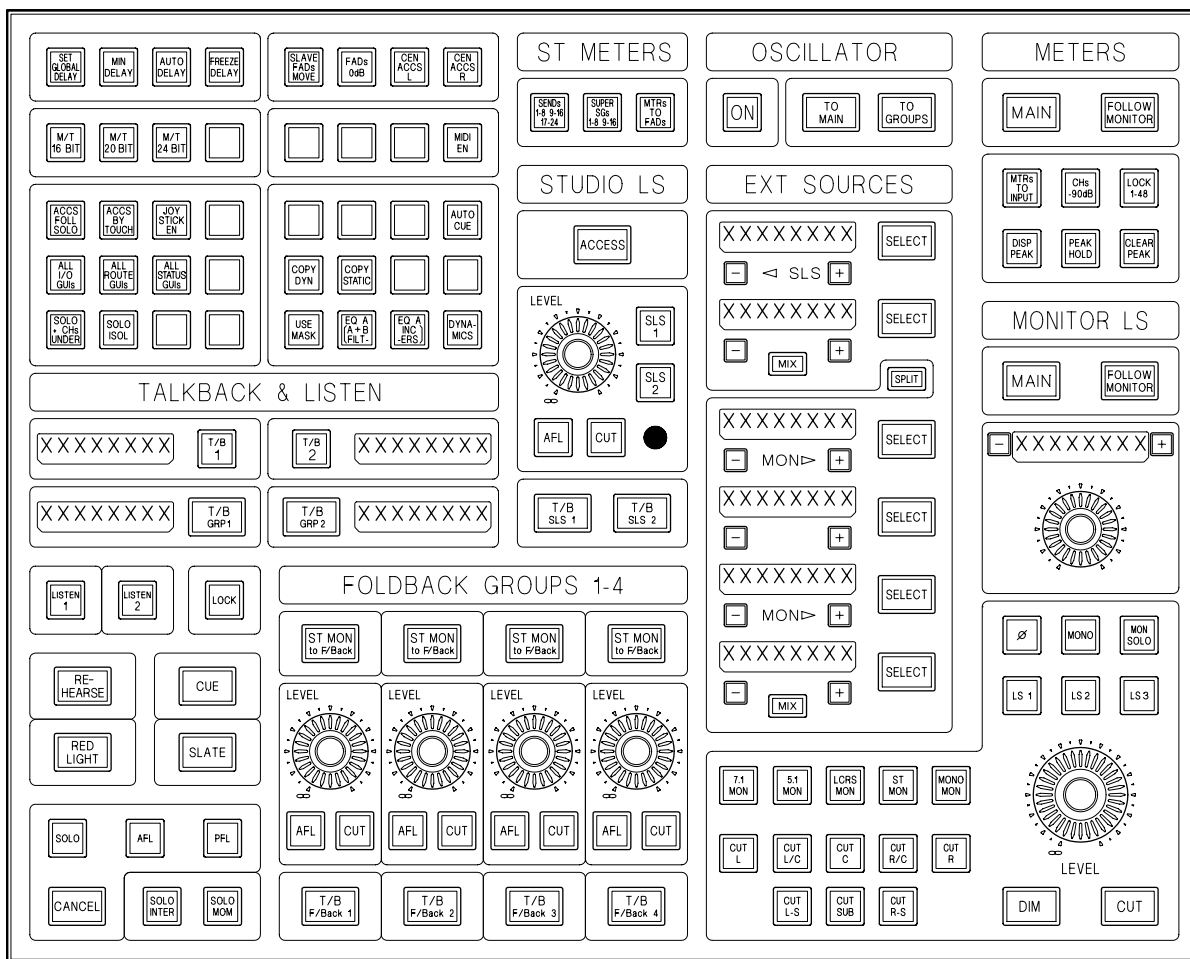
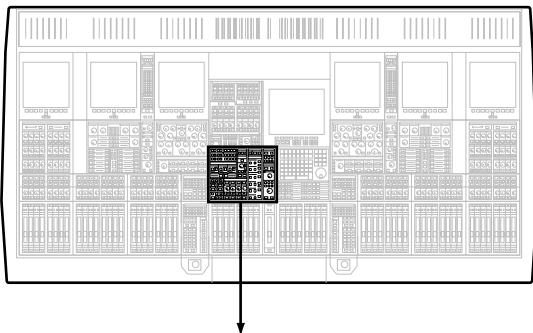

## 6-3 Central Section Panels

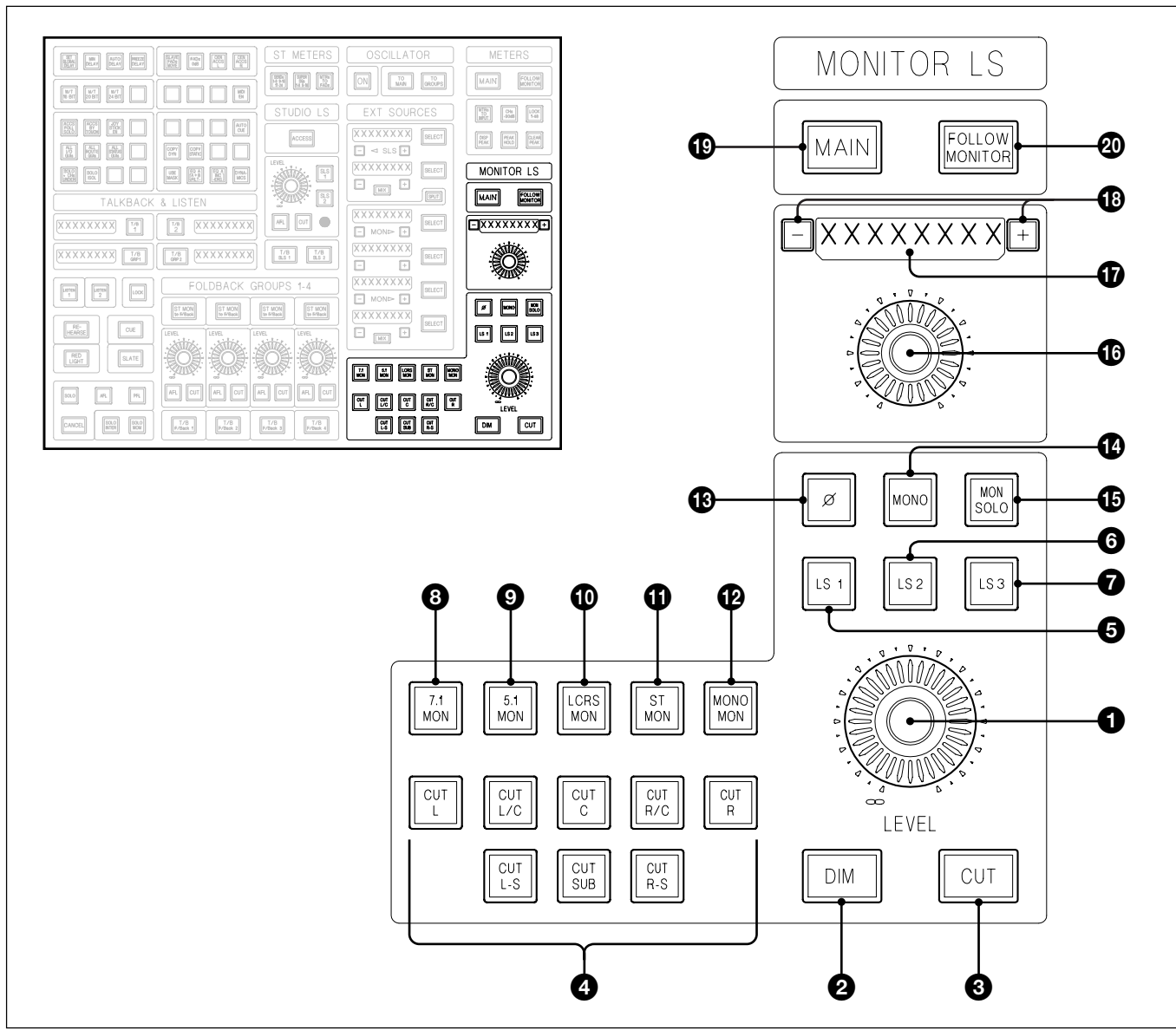

### CR MONITOR Section

**1 LEVEL Knob**

Controls the level to 3 sets of Monitor LS, the LS1 (main set), LS2 and LS3. LS1 and LS2 are surround outputs, up to 7.1, and LS3 is stereo.

**2 DIM Push-Button**

Dims all Monitor LS outputs according to the dim level setting. Set on automatically when Oscillator **[ON]** button is selected, but can be turned off manually.

**3 CUT Push-Button**

Cuts all Monitor LS outputs simultaneously.

**4 CUT L – CUT R-S Push-Buttons**

Individual Monitor LS Cuts.

**5 LS1 Push-Button**

Selects the Main Surround Monitor LS set and inter-cancels with LS2. The Calibration settings, **CAL** button selected on MULTI-FORMAT panel in the centre section, apply to LS1.

**6 LS2 Push-Button**

Selects the Secondary Surround Monitor LS set and inter-cancels with LS1. The Calibration settings do not apply to LS2.

**7 LS3 Push-Button**

Independent Stereo LS which may be switched on simultaneously with LS1 or LS2. Once LS3 is selected, LS1 and LS2 can be de-selected.

**Note:**

*If LS3 has been selected, and LS1 or LS2 has been de-selected, LS3 can be de-selected too. This means there will not be any monitor LS signal. As a warning, the LS1, LS2 and LS3 light red in rotation.*

**8 7.1 MON Push-Button**

Selects the 7.1 output from the input to the Fold-Down Matrix. “FOLDDOWN” must be selected as a source in the EXT SOURCE section of the Monitor panel. Its **SELECT** button must also be selected, in order to monitor this signal.

**9 5.1 MON Push-Button**

Selects the 5.1 output from the input to the Fold-Down Matrix. “FOLDDOWN” must be selected as a source in the EXT SOURCE section of the Monitor panel. Its **SELECT** button must also be selected, in order to monitor this signal.

**10 LCRS MON Push-Button**

Selects the LCRS output from the input to the Fold-Down Matrix. “FOLDDOWN” must be selected as a source in the EXT SOURCE section of the Monitor panel. Its **SELECT** button must also be selected, in order to monitor this signal.

**11 ST MON Push-Button**

Selects the STEREO output from the input to the Fold-Down Matrix. “FOLDDOWN” must be selected as a source in the EXT SOURCE section of the Monitor panel. Its **SELECT** button must also be selected, in order to monitor this signal.

**12 MONO MON Push-Button**

Selects the MONO output from the input to the Fold-Down Matrix. “FOLDDOWN” must be selected as a source in the EXT SOURCE section of the Monitor panel. Its **SELECT** button must also be selected, in order to monitor this signal.

**13 Ø Push-Button**

Selecting Ø sets the individual LS Cuts into a phase reverse mode. It will flash, lighting orange.

Only the LS currently on will be affected by this operation. In other words, if an LS is cut before selecting the Ø button, it will remain cut, illuminated red.

Pressing **CUT \*\*** for any other LS will cause a phase reversal for that LS. It will flash, alternating between amber and red. Any number of LS can be phase reversed.

De-selecting the Ø button will return to normal operation with all LS in phase again. Selecting Ø again will return to the previous phase reverse set-up which is memorised, allowing comparison.

### 14 MONO Push-Buttons

Select **MONO** and it will flash, lighting orange. A mono mix of the monitor source will be fed to either the Centre LS or both the L and R LS, according to the “MONO MEANS” Preference in the PREFS GUI.

Monitor LS can be freely turned on and off using the cut switches, including any which were cut before selecting **MONO**. The LS Cuts are independent of the Mono function and their settings will remain, having de-selected **MONO** in order to return to normal operation.

The overall level is compensated in accordance with the number of sources which make up the Mono signal.

### 15 MON SOLO Push-Button

Sets the LS Cut switches into a Solo mode which is totally independent of their cut functions. Having selected **MONO SOLO**, selecting any **CUT \*\*** will cause its LS to be soloed, indicated by its button lighting amber. The other LS, which are cut, will light red.

De-selecting **MONO SOLO** will resume normal operation including the previous LS Cut settings. The Solo settings are memorised and will return if **MONO SOLO** is selected again.

### 16 Definable Knob

Controls a number of parameters as listed below:

- **LS2 and LS3**

The levels for LS2 and LS3 can be set independently relative to the LS1 setting which they track.

- **DIM Level**

- **TALKBACK Level**

- **LISTEN Level**

- **MAIN OSCILLATOR**

Frequency and Level for the general purpose tone source within the R3 system.

- **HEADPHONES Level**

Sets the Level for a separate Headphones output which is taken pre the Monitor LS level. See Chapter 5 for assigning the Headphone output.



---

- **SOLO DIM Level**

Sets the output level of channels which are not soloed when **SOLO + CHs UNDER** is selected.

- ⑰ **8 Character Display**

Displays the current Definable knob function.

- ⑱ **+/- Push-Buttons**

Select the Definable knob function.

- ⑲ **MAIN Push-Button**

Fixes the Main Output Bus as the source for all Monitor LS outputs.

- ⑳ **FOLLOW MONITOR Push-Button**

Allows LS to follow all monitor source selections including AFL signals.



## 6-3 Central Section Panels

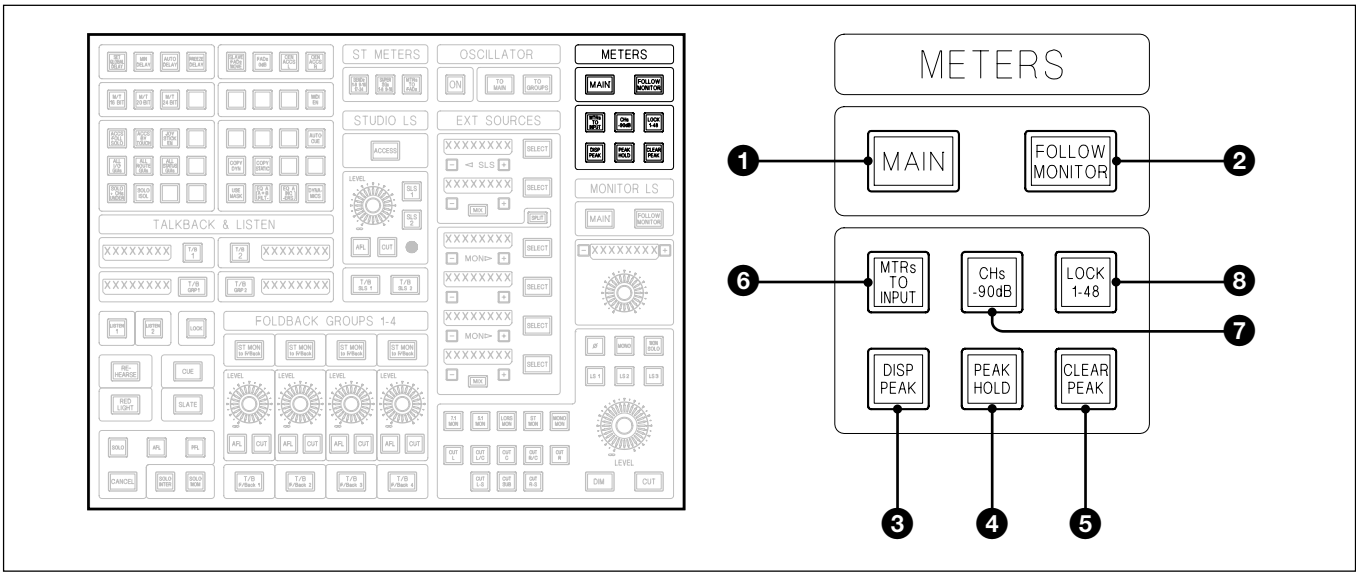

### CENTRE SECTION METERS

The meters in the centre section consist of two sets of 8 stereo meters, one set each side of a central stereo meter. They can be switched to monitor a number of sources and their function can also depend on whether the Main Output Bus is set for Stereo or Surround operation.

#### Left set of 8 Meters

The left hand 8 meters will display the output levels of SSGs 1-16 and Sends 1-24 according to the meter selector described later in this section. This is irrespective of whether Stereo or Surround is in operation.

#### Central Stereo Meter

The signal source for the Central Stereo Meter is set as follows:

- **MAIN Push-Button selected**

Can indicate the L and R signals from the Main Output Bus or L and R from the Fold-Down Matrix. This option is set in the PREFERENCES GUI described in section 5-2-5.

- **FOLLOW MONITOR Push-Button selected**

Indicates the L and R signals from the Main Output Bus or the L & R signals selected as monitor sources for the CR Monitor LS.

#### Right set of 8 Meters

The sources for the right hand 8 meters depend on whether the Main Output Bus is set for Stereo or Surround:

- **Stereo Main Output**

Indicate output level for SSGs 1-16 and Sends 1-24 according to the meter selector described later in this section.

- **Surround Main Output**

Indicate output levels for the Main Output Bus

- **1 MAIN Push-Button**

Depends on whether the Main Output Bus is set for Stereo or Surround.

Selecting **MAIN** ensures that the Main Output Bus sources are fixed to the meters irrespective of what is selected to the CR Monitor LS:

- **Stereo Main Output**

- Indicate the L and R signals from the Main Output Bus or L and R from the Fold-Down Matrix. This option is set in the PREFERENCES GUI described in section 5-2-5.
- Right set of 8 Meters indicate output level for SSGs 1-16 and Sends 1-24 according to the meter selector described later in this section.

- **Surround Main Output**

- Central Stereo Meter indicates output level for the Stereo Output from the Fold-Down Matrix which is derived from the Surround signal.
- Right set of 8 Meters indicate output levels for the Main Output Bus.

## 2 FOLLOW MONITOR Push-Button

Depends on whether the Main Output Bus is set for Stereo or Surround.

Selecting **FOLLOW MONITOR** allows the central meters to follow all monitor source selections including AFL and PFL signals:

- **Stereo Main Output**

- Central Stereo Meter indicates output level for Main Stereo and all other sources which are listened to on the CR Monitor LS, including AFL and PFL signals.
- Right set of 8 Meters indicate output level for SSGs 1-16 and Sends 1-24 according to the meter selector described later in this section.

- **Surround Main Output**

- Central Stereo Meter indicates the L and R signals from the Main Output Bus and any other source listened to on the CR Monitor LS including external sources, AFL and PFL signals
- Right set of 8 Meters indicate output levels for the Main Output Bus and all other sources which are listened to on the CR Monitor LS, including external sources, AFL and PFL signals.

## Global meter functions

This section describes functions which apply to all meters in the meter bridge except for **8**, which applies just to the channels sections.

### 3 DISP PEAK Push-Button (Global function)

Meters continue to display peaks as single segments for a period of 1.5 seconds after the signal has ceased.

### 4 PEAK HOLD Push-Button (Global function)

Meters continue to display highest peak as a single segment until CLEAR PEAK is pressed.

### 5 CLEAR PEAK Push-Button (Global function)

Clears the Peak Hold memory.

### 6 MTRs to INPUT Push-button (Global function)

Meters the channel signal immediately post input gain control.

## 6-3 Central Section Panels

### 7 CHs -90dB Push-Button (Global function)

Selects the -90dB scale on the mono channel meters (the default is -60dB).

### 8 LOCK 1-48 Push-Button

Locks the 48 channel meters to channels 1- 48.

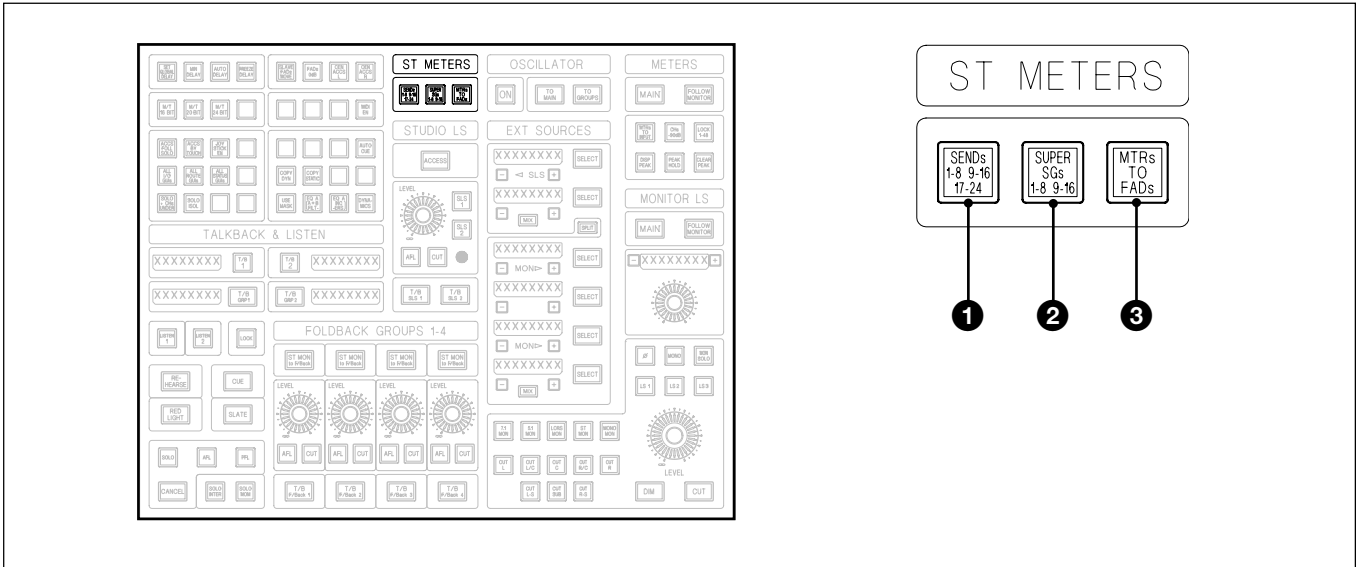

### Central Stereo Meters

These functions apply to the 16 Stereo Meters, in two groups of 8, above the centre section of the control surface. Their function depends on whether the Main Output Bus is set for Stereo or Surround.

#### • Stereo Main Output

Both groups of 8 meters are used for this function, allowing 16 outputs to be metered simultaneously.

#### • Surround Main Output

Just the left hand groups of 8 meters are used for this function, allowing 8 outputs to be metered simultaneously.

### 1 SENDs 1-8 9-16 17-24 Push-Button

If not already selected, pressing **SENDs 1-8 9-16 17-24** for the first time sets the meters source as Sends 1-8 and 9-16 for when the Main Output is Stereo, or 1-8 if the Main Output is Surround. Further presses rotate the sequence.

### 2 SUPER SGs 1-8 9-16 Push-Button

If not already selected, pressing **SUPER SGs 1-8 9-16** for the first time sets the meters source as Super SGs 1-8 and 9-16 for when the Main Output is Stereo, or 1-8 if the Main Output is Surround. Further presses rotate the sequence for Surround Main Output.

### 3 MTRs TO FADs Push-Button

Sources for the Meters are selected depending on which faders are assigned in the SEL section of the SELECT TO FADERS panel.

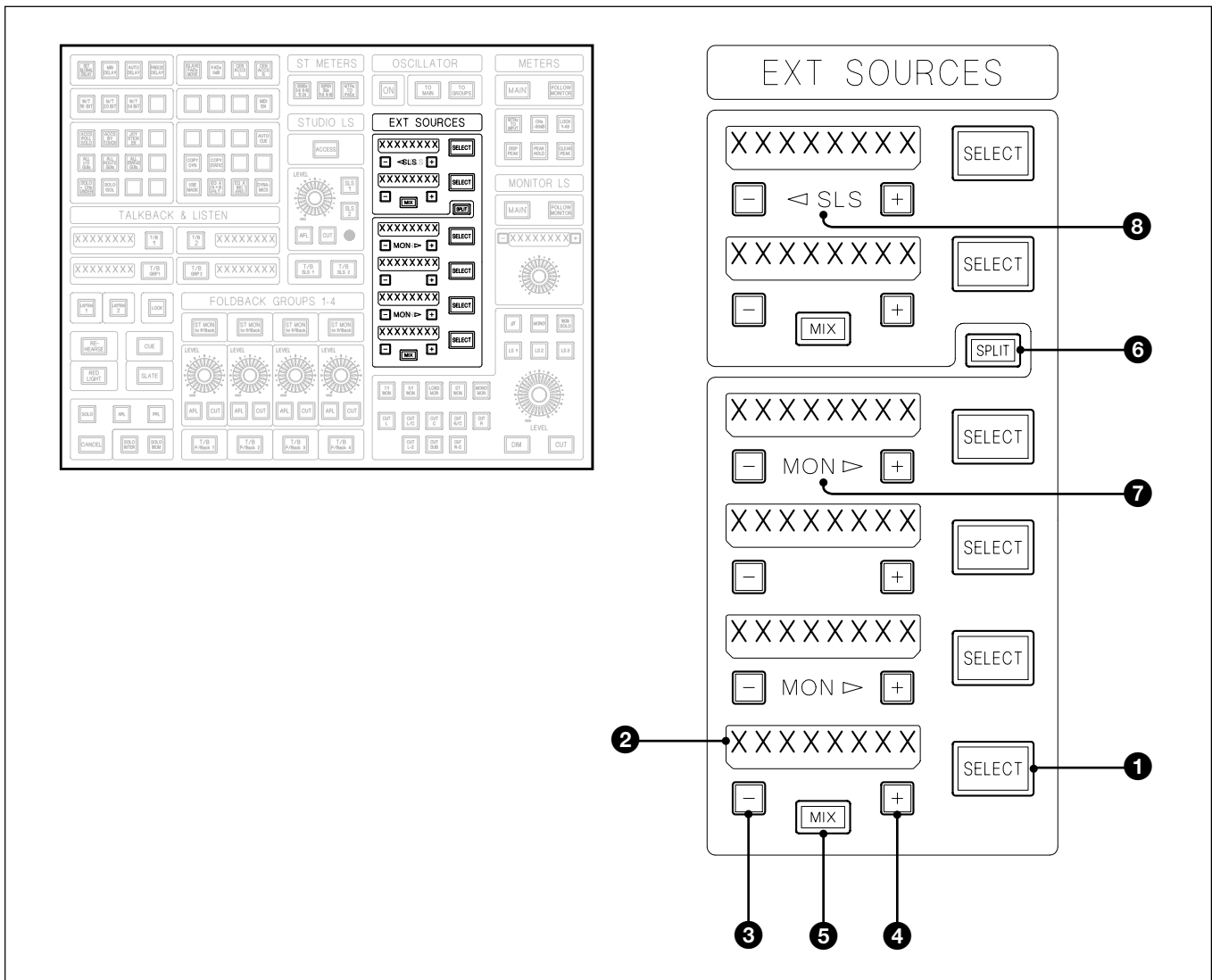

## External Sources

The External Source selector allows selection of multiple surround and stereo external audio sources.

### ❶ SELECT Push-Buttons

Feed the source, indicated in their adjacent displays, to the monitor LS in place of the current monitor source. De-selecting will return to the Main Output source. The 6 SELECT buttons inter-cancel. (Refer to Chapter 5 for details of External I/O Input assignments).

### ❷ 8 Character Displays

Indicate External Source names.

### ❸, ❹ +/- Push-Buttons

Allow selection of external sources for each individual **SELECT** button.

### ❺ MIX Push-Buttons

SELECT push-buttons normally inter-cancel unless **MIX** is selected, in which case the switches do not inter-cancel and the sources add together.

## 6-3 Central Section Panels

---

### ⑥ SPLIT Push-Button

All 6 external source selections will normally feed both Control Room Monitor LS and Studio LS outputs. If **SPLIT** is selected, the upper pair of SELECT SOURCE buttons feed the studio LS only, and the lower 4 selectors feed the Control Room Monitors. Their **MIX** functions are also separated.

### ⑦ MON ► Indicators

Are displayed when **SPLIT** is selected and indicate that the four lower external sources will feed the CR Monitor LS only.

### ⑧ ◀ SLS Indicator

Is displayed when **SPLIT** is selected and indicates that the two upper external sources will feed the Studio LS only.

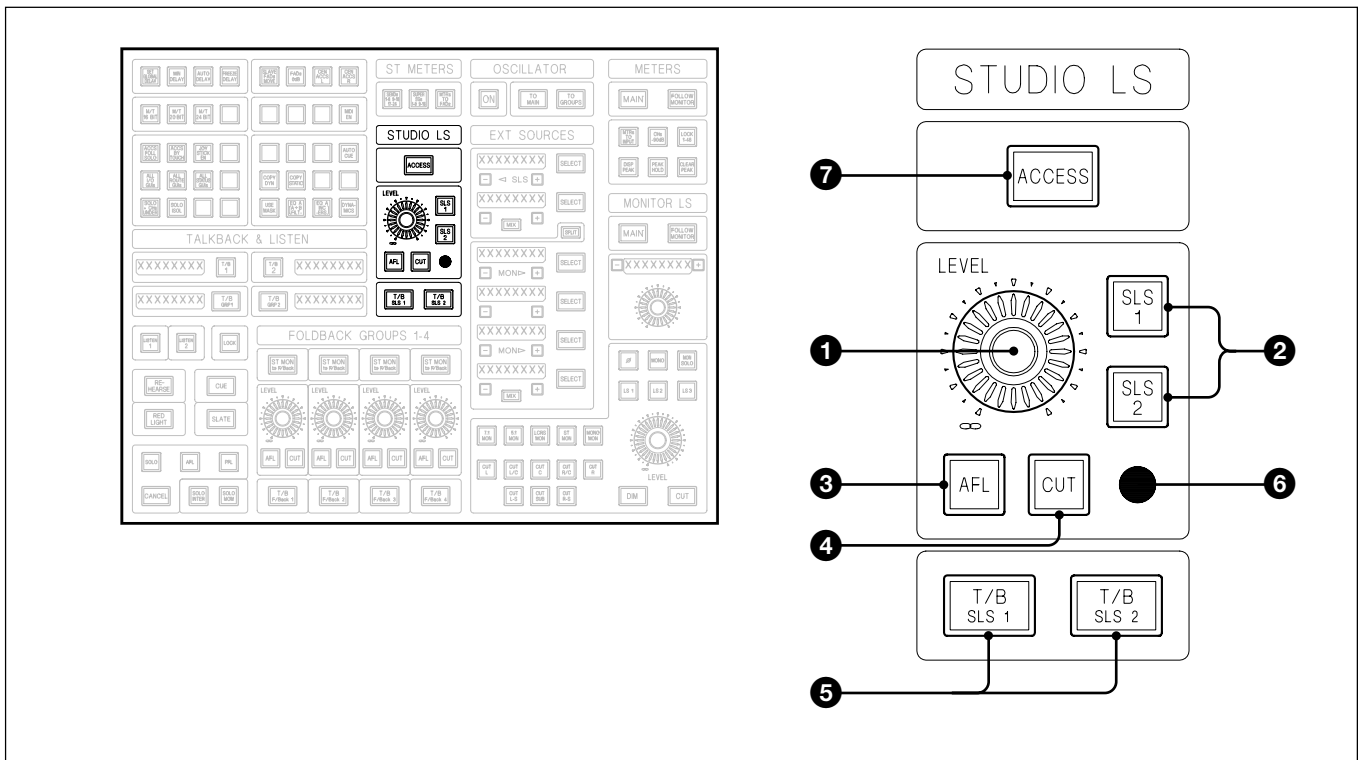

## Studio LS

This section allows control of 2 pairs of Studio LS. The source selection for the Studio LS has been described in the previous section.

### ❶ LEVEL Knob

Controls the level to the 2 stereo Studio LS outputs.

### ❷ SLS1 and SLS2 Push-Buttons

Allow the two Studio LS outputs to be switched on individually.

### ❸ AFL Push-Button

Sends After Fader Listen (AFL) signal to CR monitor LS regardless of the status of SLS1 and SLS2 push-buttons.

### ❹ CUT Push-Button

Mutes SLS regardless of status of the SLS1 and SLS2 push-buttons.

### ❺ T/B SLS1 and T/B SLS2 Push-Buttons

Allows talkback to be fed to SLS1 and SLS2 individually.

### ❻ Talkback Microphone

### ❼ ACCESS Push-Button

Not operational in this version.

## 6-3 Central Section Panels

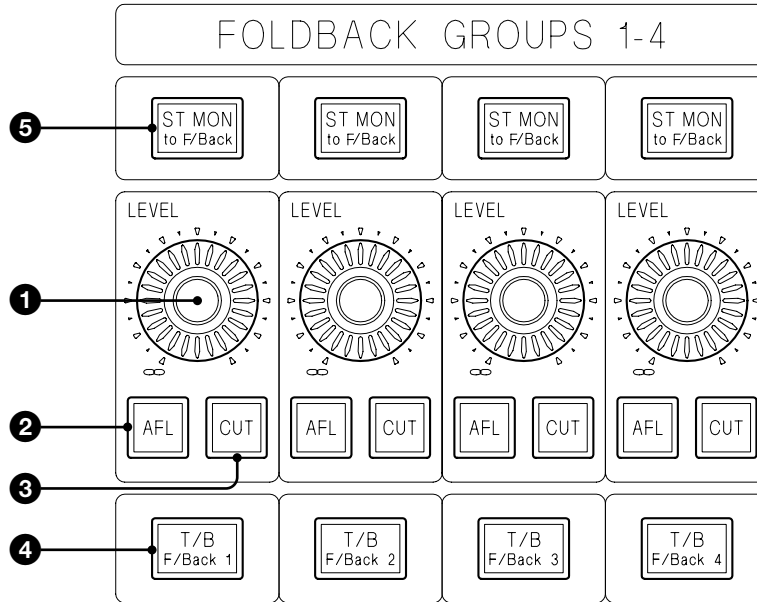
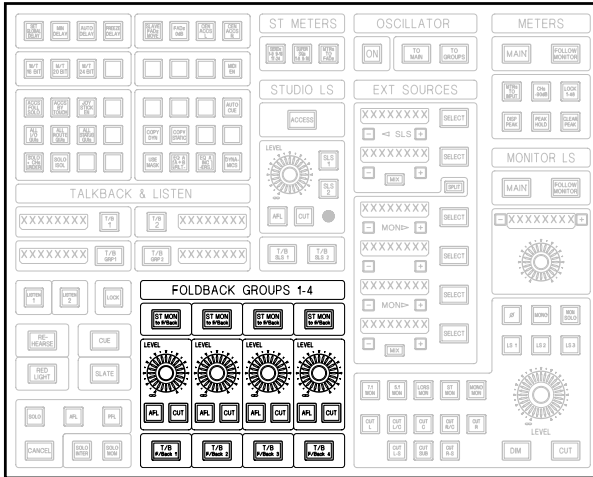

### Foldback Groups 1-4

The 4 Stereo Foldback Groups have fixed source assignments as follows:

- **F/B1L** – **Send Bus 17**
- **F/B1R** – **Send Bus 18**
- **F/B2L** – **Send Bus 19**
- **F/B2R** – **Send Bus 20**
- **F/B3L** – **Send Bus 21**
- **F/B3R** – **Send Bus 22**
- **F/B4L** – **Send Bus 23**
- **F/B4R** – **Send Bus 24**



---

**❶ LEVEL Knobs**

Set output levels for each individual Foldback Group.

**❷ AFL Push-Buttons**

Send After Fader Listen (AFL) signals to CR monitor LS.

**❸ CUT Push-Buttons**

Mute individual Foldback Group outputs.

**❹ T/B F/Back 1 (-4) Push-Buttons**

Enable individual talkback feeds to be sent to each of the four Foldback Groups. T/B F/Backs may be assigned to Talkback Groups 1 and 2.

**❺ ST MON to F/back Push-Buttons**

Replace the signal from the Send Busses with the Stereo Monitor signal when the Main Output Bus is set for stereo. Replace the Send Bus signals with the Stereo Output from the Fold-Down Matrix for a surround Main Output.

## 6-3 Central Section Panels

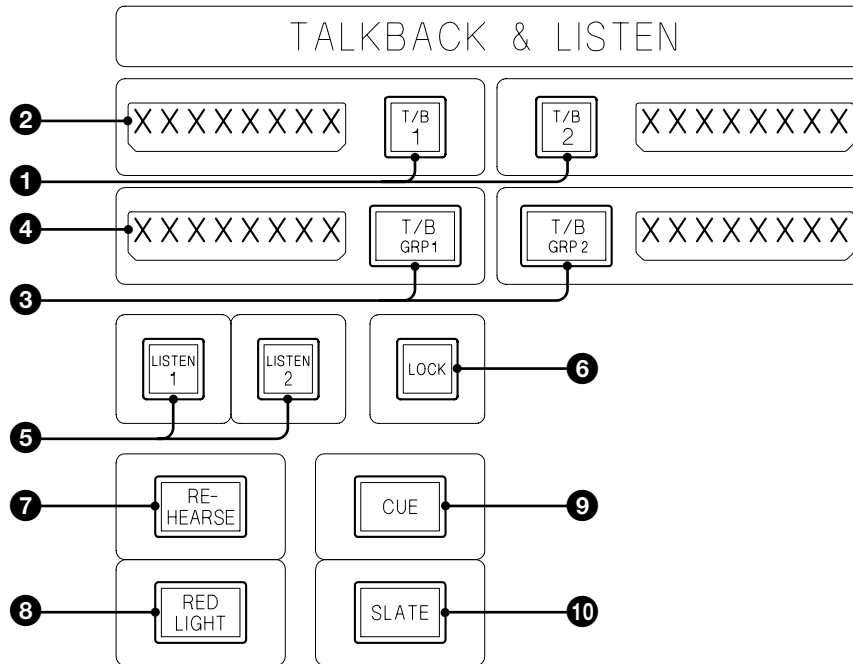
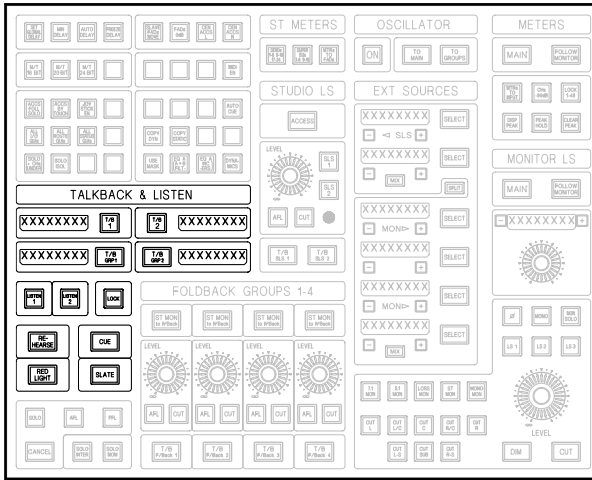

### Talkback & Listen

#### 1 T/B 1 & T/B 2 Push-Buttons

**T/B 1** and **T/B 2** are included for connection to GPIO (General Purpose Inputs & Outputs) utilising relay closures and opto-coupled tally inputs. Pressing a T/B button sends talkback to the destination displayed within its dot display. A short press latches the switch on, requiring a further press to release it. Holding the switch down enables a momentary action. The CR monitors may optionally dim when talkback is in use.

#### 2 8 Character Displays

Display T/B destination names as designated via the SCRIBBLES GUI accessed via the MASTER GUI.

### ③ T/B GRP 1 & T/B GRP 2 Push-Buttons

Allow combinations of T/B outputs to be switched on simultaneously. A group is set up by pressing and holding one of the T/B GROUP buttons and momentarily pushing other T/B buttons required in that group. The T/B GROUP button is then released. Any T/B button, such as Foldback or SLS, may be selected as part of a group. Any T/B button which belongs to a group retains its individual functionality. T/B GROUPS have latching and momentary actions and may optionally dim CR monitor LS.

### ④ 8 Character Displays

Display T/B Group names as designated via the SCRIBBLES GUI accessed via the MASTER GUI.

### ⑤ LISTEN 1 Push-Button

Send the listen Mic signal to CR monitors with either a momentary or latching action. The Listen signal replaces the normal monitor signal.

### ⑥ LOCK Push-Button

Locks out SOLO-IN-PLACE, which is replaced with AFL. The Oscillator is locked out, as is the Slate function.

### ⑦ REHEARSE Push-Button

Latches a relay closure for the Rehearse signal. A further press unlatches it.

### ⑧ RED LIGHT Push-Button

Latches a relay closure for RED LIGHT signal. A further press unlatches it.

### ⑨ CUE Push-Button

Enables a momentary relay closure to send a CUE signal.

### ⑩ SLATE Push-Button

Sends talkback to all normal destinations and, additionally, to the channel Group outputs.

## 6-3 Central Section Panels

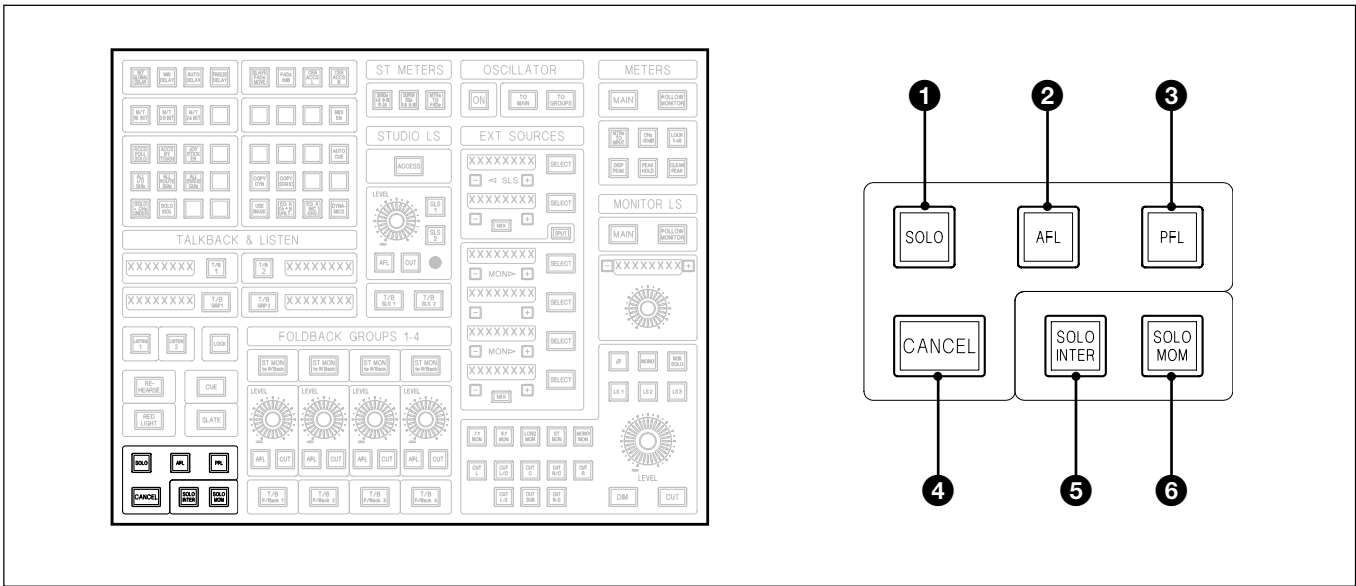

### Solo, AFL & PFL Modes

#### ❶ SOLO Push-Button

Sets the channel fader SOLO buttons to destructive SOLO-IN-PLACE mode. Stereo AFL continues to operate for all buttons designated as such.

#### ❷ AFL (After Fader Listen) Push-Button

Sets channel fader SOLO buttons to a non-destructive AFL mode. Other AFL buttons continue as normal.

#### ❸ PFL (Pre Fader Listen) Push-Button

Sets channel fader SOLO buttons to non-destructive PFL mode. Other AFL buttons continue as normal.

#### ❹ CANCEL Push-Button

Cancels any latched SOLO or AFL buttons.

#### ❺ SOLO INTER Push-Button

Puts the SOLO and AFL buttons into an inter-cancelling mode.

#### ❻ SOLO MOM Push-Button

Puts the SOLO and AFL buttons into a momentary mode.

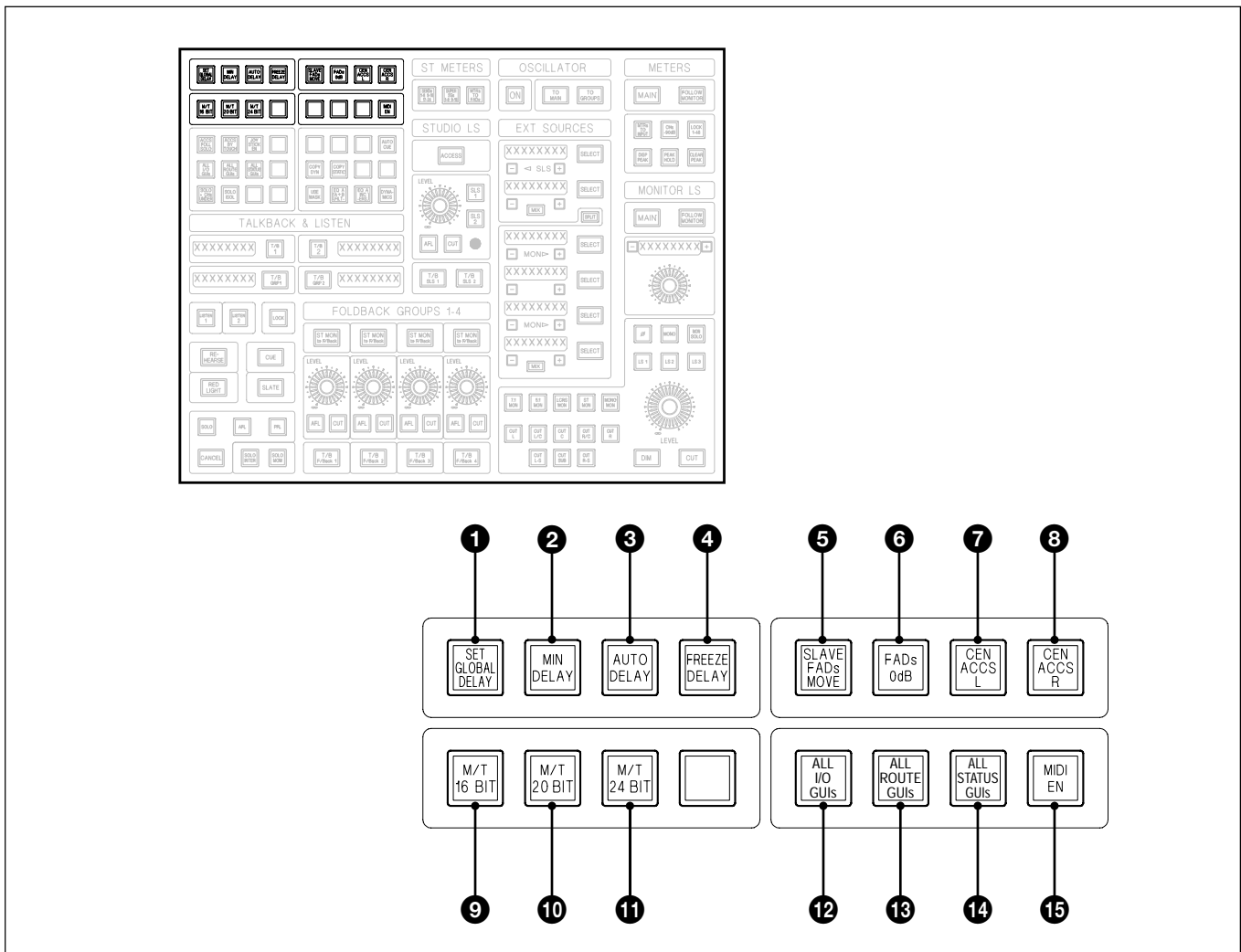

## Upper Ancillary Push-Button Block

### 1 SET GLOBAL DELAY Push-Button

This delay function, up to 80ms, is in addition to the delay function within channels. It allows channels to be delayed or advanced, relative to other channels, on a global basis. The delay is inserted at the channel output, pre fader.

#### Note:

*The Global Delay function is usable only when [CHANS] is selected at the SELECT TO FADERS panel. It is not operable when [FADs 0dB] is selected either.*

Global Delay procedure:

- 1 Press [SET GLOBAL DELAY] and it flashes. The 8 character dot display above the definable knob situated above the Monitor Level indicates the current Global Delay value. An arrow to the left of the display alternates to alert that this function is displayed. The lower [ACCESS] buttons will also go out.

- 2** Adjust the definable knob to change the delay factor for all channels. The delay is displayed in ms or samples. Use  and  buttons either side of the display to change the parameter type. The knob normally operates in a fine-tune mode. Press and hold the knob whilst turning it for coarse adjustments.
- 3** To isolate individual channels from the Global Delay adjustment, select  but before making any adjustments, press the  buttons on the individual channels. Those channels will remain at their current Global Delay setting.
- 4** De-select  buttons and select others if necessary, or release  to return to normal operations.

To reset Global Delay, select  and then press and hold the  and  buttons, either side of the display above the definable knob, for at least 2 seconds.

### Channel Delay

Channels have local Delay control allowing offsets from Global Delay. To adjust the local Delay:

- 5** Select  for the channel to be adjusted. Select  at the FREE ASSIGN AREA & DYNAMICS panel.
- 6** Adjust the knob labelled 'GLOBAL DELAY' at the right hand side of the panel. The offset value will be displayed whilst the knob is adjusted, and for a few seconds after its release. For continuous display of the offset value, click on 'ALWAYS' on the GDC DISPLAY option in the PREFS GUI (see Chapter 5 for details).

### ② MIN DELAY Push-Button

The processing delay in the SP system has no compensation. In other words, the delay through any channel is at its minimum, totally dependent upon the amount of processing inserted in that channel.

### ③ AUTO DELAY Push-Button

Delay compensation is inserted in the SP system for all channels according to the processing of the channel with most processing, and hence the longest delay, in order that the outputs of all channels are time-aligned.

### ④ FREEZE DELAY Push-Button

The delay compensation factor in the SP system is fixed for all channels according to the delays in operation at the time FREEZE DELAY is latched.

**5 SLAVE FADs MOVE Push-Button**

Faders slaved to Control Group faders will move according to the Control Group fader, displaying their exact contribution to the mix.

**6 FADs 0dB Push-Button**

To set faders at unity gain, latch FADs 0dB and press ACCESS for the appropriate faders and they will light. Then de-select FADs 0dB if the faders are to retain their 0dB setting, in other words they will 'rubber band' back, or de-select ACCESS buttons before FADs 0dB is released.

**7 CEN ACCS L Push-Button**

Selects the left hand Channels Section to be assigned to the Main L/R Fader when its ACCESS, or any other centre section ACCESS, is latched.

**8 CEN ACCS R Push-Button**

Selects the right hand Channels Section to be assigned to the Main L/R Fader when its ACCESS, or any other centre section ACCESS, is latched.

**Note:**

*CEN ACCS L and CEN ACCS R may be latched simultaneously.*

**9 M/T 16 BIT Push-Button**

Sets Word Length for the MADi output feeding the multitrack to 16 bits.

**10 M/T 20 BIT Push-Button**

Sets Word Length for the MADi output feeding the multitrack to 20 bits.

**11 M/T 24 BIT Push-Button**

Sets Word Length for the MADi output feeding the multitrack to 24 bits.

**12 ALL I/O GUIs Push-Button**

Latching function which sets the I/O GUIs on all 6 LCD screens. Release **ALL I/O GUIs** to return to previous GUIs.

**13 ALL ROUTE GUIs Push-Button**

Latching function which sets the ROUTE GUIs on all 6 LCD screens. Release **ALL ROUTE GUIs** to return to previous GUIs.

**14 ALL STATUS GUIs Push-Button (Not operational in this version)**

Latching function which sets the STATUS GUIs on all 6 LCD screens. Release **ALL STATUS GUIs** to return to previous GUIs.

**15 MIDI EN(able) Push-Button**

Overall MIDI enable/disable for all MIDI outputs.

## 6-3 Central Section Panels

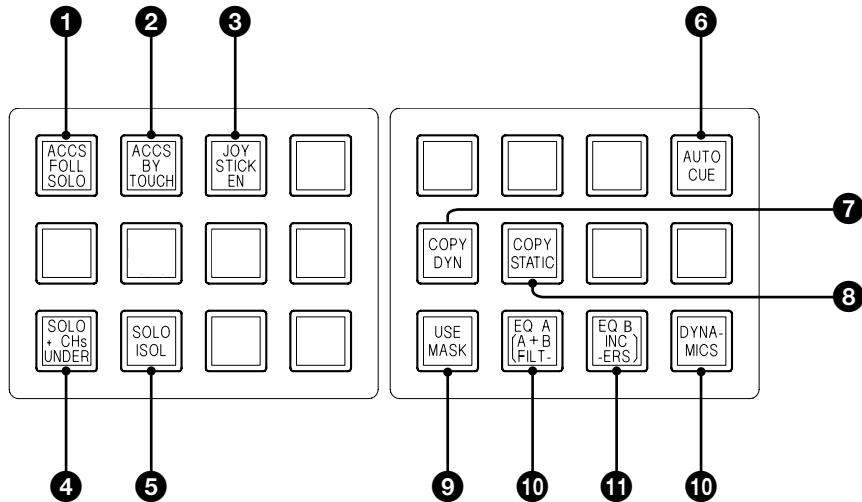
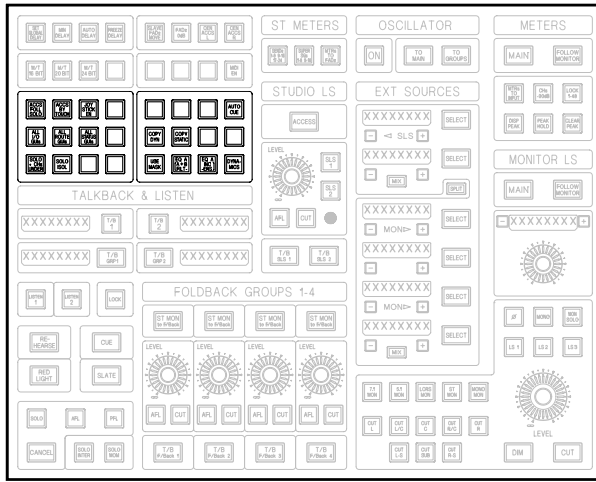

### Lower Ancillary Push-Button Block

#### ❶ ACCS FOLL SOLO Push-Button

Any Channel ACCESS function is selected automatically by pressing its Fader **[SOLO]** push-button, equivalent to pressing the **[SOLO]** and **[ACCESS]** simultaneously.

#### ❷ ACCS BY TOUCH Push-Button

Any Channel ACCESS function is selected automatically by touching its fader knob.

#### ❸ JOY STICK EN(able) Push-Button

Latching function which enables the motor power in the Motorised Joy Sticks.



#### 4 SOLO + CHs UNDER Push-Button

Sets a Solo mode where channels which are not soloed can be heard at a reduced level. The level is set using the Definable knob above the Monitor Level control. Use the **+** and **-** buttons either side of the 8 character display above the Definable knob to select DIM LEVEL, and adjust to suitable level.

#### 5 SOLO ISOL Push-Button

To isolate channels from the solo-cut bus, latch SOLO ISOL and select their channel SOLO buttons. Then de-latch SOLO ISOL. Reverse the procedure to de-isolate channels. Latching SOLO ISOL will cause the SOLO buttons on isolated channels to light.

#### 6 AUTO CUE Push-Button

Latching function linked to T/B GROUP 2 push-button. When AUTO CUE is selected, T/B GROUP 2 will be permanently latched on apart from when the tape is rolling. This enables talkback at all times except when the tape is playing or recording. Talkback buttons (e.g. T/B F/Back 1-4) must be assigned to T/B GROUP 2 for this function.

#### Buttons related to Copy

The following descriptions relate to Copy functions which are carried out using the Channel **ACCESS** buttons described in detail in Chapter 7. Here is a brief description of copying and/or linking the settings of one channel to others:

##### COPY

- Press and hold upper **ACCESS** button of source channel until it turns amber.
- Press and release upper **ACCESS** buttons on destination channels.

##### LINK

- Press and hold lower **ACCESS** button of source channel until it turns amber.
- Press and release lower **ACCESS** buttons on destination channels.

##### COPY & LINK

- Press and hold lower **ACCESS** button of source channel until it turns amber.
- Press and release upper **ACCESS** buttons on destination channels.

#### 7 COPY DYN Push-Button

This is a latching function and applies to all 'COPY' and 'QUICK COPY' functions, which are performed using button push operations (these are described in Chapter 7). If **COPY DYN** is selected, any copy operations will include dynamic automation data. **COPY DYN** inter-cancels with **COPY STATIC** 8, or it can be turned on and off, when it returns to defaults.

#### 8 COPY STATIC Push-Button

This is a latching function and applies to all 'COPY' and 'QUICK COPY' functions, which are performed using button push operations (these are described in Chapter 7). If **COPY STATIC** is selected, any

## 6-3 Central Section Panels

---

copy operations will be limited to static settings only. **COPY STATIC** inter-cancels with **COPY DYN** **7**, or it can be turned on and off, when it returns to defaults.

### **9 USE MASK Push-Button**

Sets Copy and Link operations according to the DEFAULTS in the SNAPSHOTS, COPY & LINK GUI (see Chapter 7 for details).

### **10 EQ A Push-Button**

Limits Copy and Link functions to Equaliser A settings.

### **11 EQ B Push-Button**

Limits Copy and Link functions to Equaliser B settings.

### **12 DYNAMICS Push-Button**

Limits Copy and Link functions to Dynamics section settings.

#### **Note:**

**USE MASK** inter-cancels with **EQ A** or **EQ B** or **DYNAMICS**. But **EQ A**, **EQ B** and **DYNAMICS** can be used in any combination. If **EQ A** and **EQ B** are on simultaneously, the Filters are also included in Copy and Link operations.

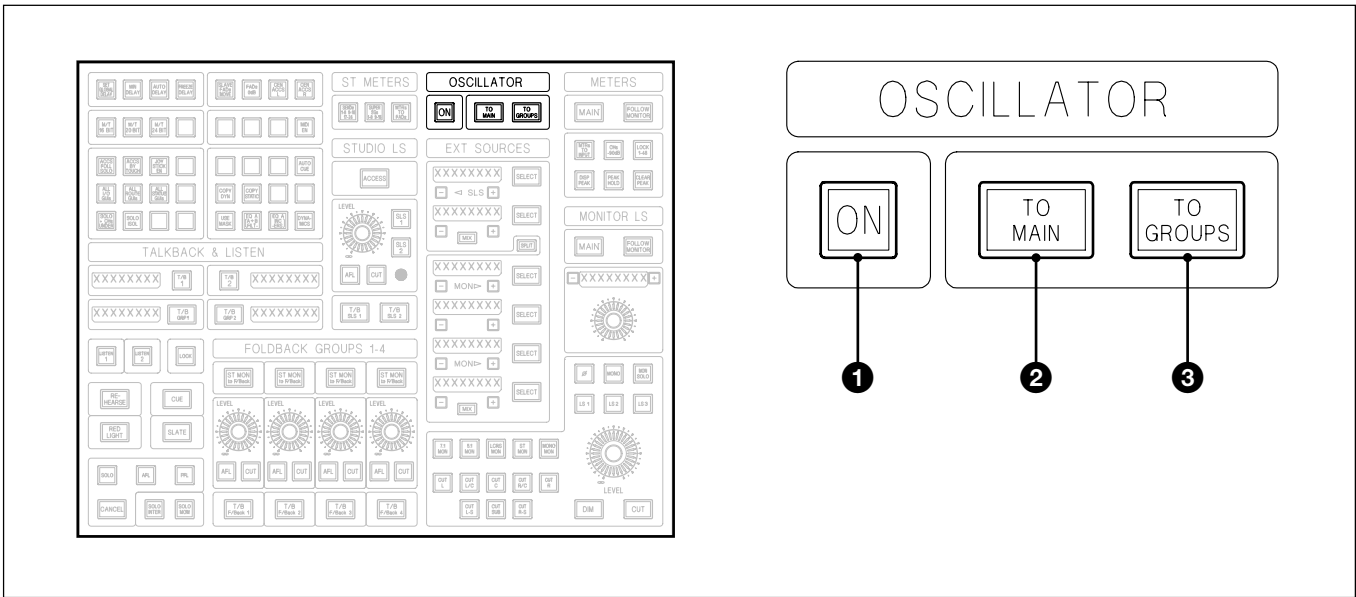

### OSCILLATOR Section

The Sine Wave oscillator source frequency and level are controlled from the definable knob above the CR Monitor level knob. The frequency is variable from 20Hz to 20kHz and the level is variable between -70dB and 0dB (digital full scale) in 1dB increments. The default Oscillator output is 0dB @ 1kHz. The push-button controls on the Monitor Panel function as follows:

#### ❶ ON Push-Button

Switches the oscillator on, which also automatically sets monitor DIM on. (It can be switched off again if required). TONE buttons in SSGs and Sends sections are inoperative unless the Oscillator ON is selected.

#### ❷ TO MAIN Push-Button

Replaces the Main Output Bus signal with the oscillator signal. The Oscillator ON button must be selected. The CR Monitor LS dim automatically.

#### ❸ TO GROUPS Push-Button

Sends the Oscillator output to all multitrack Group outputs replacing bus signals. The Oscillator ON must be selected.

## 6-3 Central Section Panels

### 6-3-3 Control Keyboard Panel

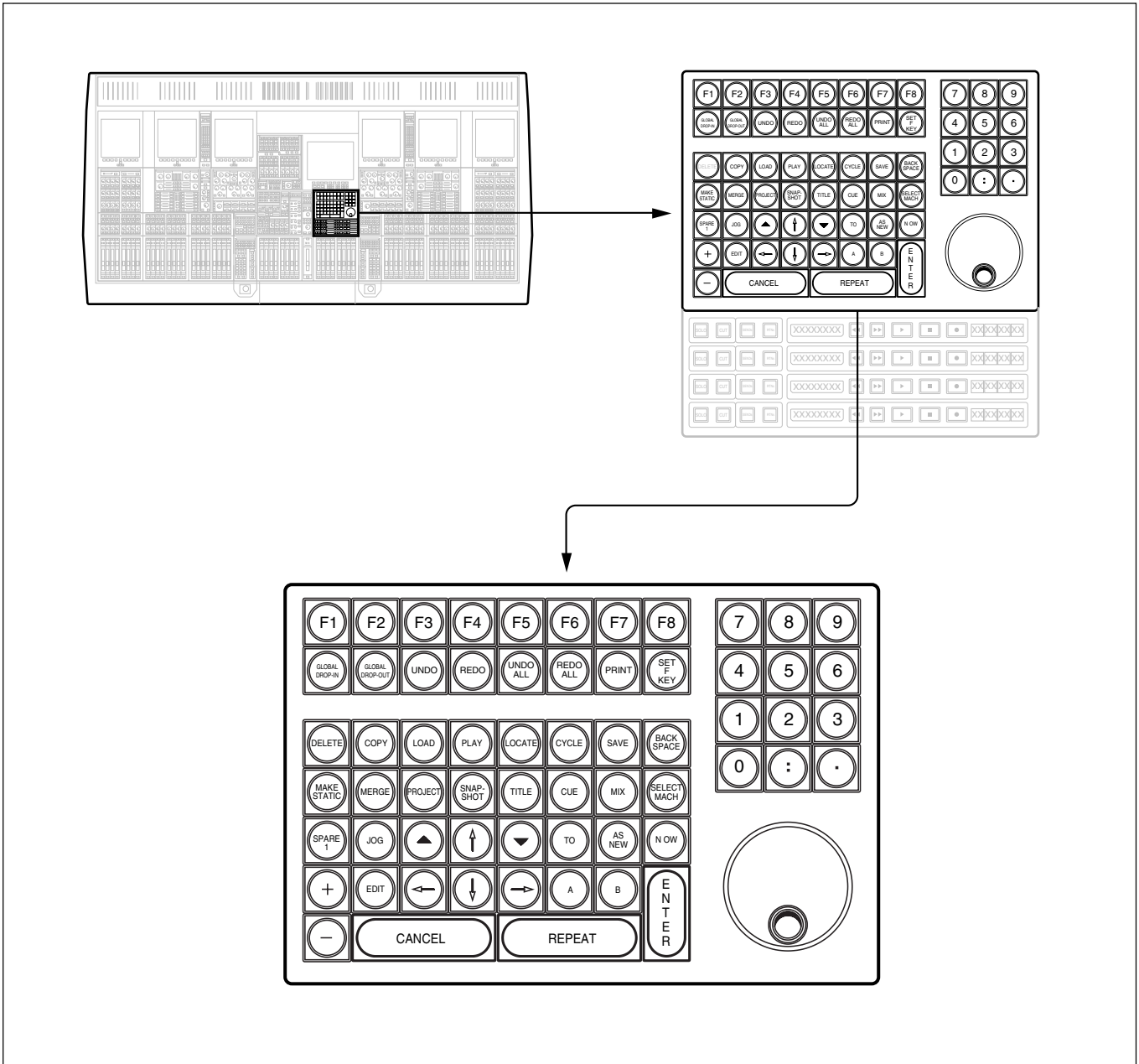

#### CONTROL KEYBOARD

This panel contains the Control Keyboard dedicated to the Session Management™ and system automation, along with 4 sets of Tape Remotes.

#### Dedicated Keys

The majority of commands are implemented using the dedicated command keys on this keyboard. The QWERTY keyboard, housed under a sliding cover between the Trackerballs in the centre section, is used mainly to type in specific names for Titles, Cues and Tracks, etc.

## Jog Wheel functions

The Jog Wheel can be used for various functions which are set using the **[JOG]** key on the Control Keyboard. Pressing **[JOG]** will cause the current Jog Knob function to be displayed in the Command Line bar at the bottom of the central LCD screen situated above the Control Keyboard. Further presses will cycle through the Jog Wheel functions one at a time. Display the function required. No further action is necessary.

### Note:

- 1 The Jog Wheel works for the Master Machine only during transport control.
- 2 The transport keys **◀◀** and **▶▶** light up amber for normal operation but light green during operations involving the Jog Wheel.

The Jog Wheel functions are as follows:

### Jog

Rotating the Jog Wheel will cause the tape to move in the direction of rotation and in relation to the speed of rotation. The tape motion will stop once the Jog Wheel is released.

### Crawl

Crawl causes the tape to shuttle progressively faster according to the rotation of the Jog Wheel, but only during rotation.

### Shuttle

Rotating the Jog Wheel will cause the tape to roll progressively faster in the direction of rotation up to Fast Forward and Rewind speeds. The motion is retained when the wheel is released. To stop the tape either rotate the wheel in the reverse direction and return to the null point or press the transport **■** key which will redefine the null point to the current position.

### Data +/-

Adjustments may be made to numerical values such as timecode according to the placement of the orange highlight in the central LCD screen. This function applies to any pop-ups where numerical values can be set such as timecode and dBs.

### Off

Jog function not operational.

## 6-3 Central Section Panels

### CONTROL KEYBOARD Command Lines

Command Lines (sequences of commands) always require **ENTER** as the last keystroke of the sequence: e.g. **PLAY** **MIX** **ENTER**.

The ‘boxed’ upper case words such as **PLAY** and **MIX** refer to the legends printed on the dedicated keys.

**Note:**

*There are exceptions which do not require **ENTER** to action commands or functions: the Function Keys, **F1** - **F8** when they have macros stored which include **ENTER**, the **NOW** and **JOG** keys.*

### Function Keys

Frequently used Command Lines may be stored on Function Keys **F1** - **F8** for fast access.

To store a Command Line, perform the sequence of keystrokes then:

Press: **SET F KEY** **F1**

This action stores the sequence under Function Key **F1**, overwriting any sequence stored previously. Alternatively:

Press: **SET F KEY**

Perform the sequence of key strokes

Then press: **F1**

To execute a stored Command Line which includes **ENTER**:

Press: **F1**

To execute a stored Command Line which does not include **ENTER**:

Press: **F1** **ENTER**

**Note:**

*In this case, just pressing **F1** displays the command line in the User Command Dialogue Line bar.*

To delete a stored Command Line:

Press: **DELETE** **F1**

### “PRINT” Command Lines

**PRINT** **F#**

Displays the command strings stored in **F#**.

**PRINT** **ENTER**

Prints the GUI currently displayed on the central LCD.

**PRINT** **PROJECT** **ENTER**

Prints details of the current Project.

**PRINT** **TITLE** **ENTER**

Prints details of the current Title.

**Note:**

*“Print” output commands require the system to be configured with a Postscript compatible printer.*

## Command Key Functions

**GLOBAL DROP-IN** **Key**

Causes all controls in automation ‘ready’ status to drop in to automation write.

**GLOBAL DROP-OUT** **Key**

Causes all controls to drop out of automation record returning to automation ‘ready’ status.

**Note:**

*‘Film Mode’ allows the system to be set up so that **GLOBAL DROP-IN** and **GLOBAL DROP-OUT** are operational on all controls except Faders, Cuts and Pans (see section 7-7-9).*

## “UNDO” & “REDO” for Automation Data

**UNDO** **Key**

Causes the system to go back one mix pass at a time for each **UNDO** through the currently unsaved mixes in memory, until the point of the last **SAVE MIX** command point is reached.

**REDO** **Key**

Reverses the effect of **UNDO** commands one by one.

**UNDO ALL** **Key**

Reverts all the way back to the last **SAVE MIX** command point.

**REDO ALL** **Key**

Cancels the effect of the **UNDO ALL** key.

## Ranges and Lists

Channels, Control Groups and the Main Fader can be specified in command lines for certain functions:

Ranges are specified with ‘..’ as a separator.

1..108       = Channels 1-108  
01..032     = Control Group Faders 1-32  
00           = Main Fader

Individual items are separated by ‘.’



2 . 4 . 25   = Channels 2, 4, and 25

## 6-3 Central Section Panels

Unlimited strings are possible in the same entry  
e.g. 00 . 01 . 03 . 05 .. 08 . 1 .. 24 . 48 .. 56 . 65 =  
Main Fader, Control Group Faders 1, 3, and 5-8  
Channels 1-24, 48-56 and 65

### “UNDO” & “REDO” for Static Settings

#### **UNDO** Key

**UNDO** used in conjunction with the key labelled SPARE 1 in the illustration,  on the Control Keyboard itself, allows the undoing of static changes, such as knob adjustments and button pushes. Press and hold  and then press **UNDO** to undo static changes one at a time. Up to 256 static changes are held in memory.

#### **REDO** Key

Holding  and pressing **REDO** reverses the **UNDOS**, one at a time for each press.

#### **UNDO ALL** Key

Holding  and pressing **UNDO ALL** once, removes all static changes in the memory.

#### **REDO ALL** Key

Holding  and pressing **REDO ALL** once, reverses the effect of the **UNDO ALL** key.

### “DELETE” Command Lines

When using DELETE commands, a dialogue box requires confirmation or cancellation.

**DELETE** **PROJECT** **ENTER**

Deletes the currently highlighted PROJECT, including its TITLES, MIXES, SNAPSHOTS and CUES.

**DELETE** **PROJECT** # **ENTER**

Deletes the specified numbered PROJECT.

**DELETE** **PROJECT** 1 . 3 . 5 **ENTER**

Deletes PROJECTS 1, 3 and 5.

**DELETE** **PROJECT** 1 .. 5 **ENTER**

Deletes PROJECTS 1-5 inclusive.

#### **Note:**

*The Command Lines above may be applied in a similar way for deleting Titles, Mixes, Snapshots and Cues, substituting the appropriate word for PROJECT in each instance.*

**DELETE** **TITLE** **ENTER**

Deletes the currently highlighted TITLE (including its MIXES, SNAPSHOTS & CUES).



**DELETE** **F1** (or other F Key) **ENTER**

Deletes the F1 (or other F Key) macro sequence.

### “COPY” Command Line

**COPY** **ENTER**

Cause the SNAPSHOTS, COPY & LINK GUI to appear along with the pop-up allowing Snapshots to be copied. Make appropriate selections according to the pop-up and click on OK or press **ENTER**.

### “LOAD” Command Lines

**LOAD** **SNAPSHOT** **ENTER** or **LOAD** **SNAPSHOT** # **ENTER**

Loads the currently highlighted SNAPSHOT or one specified by number according to SNAPSHOT Defaults settings in the Snapshots GUI.

Ranges and Lists can be specified when loading Snapshots:

**LOAD** 1..5 **SNAPSHOT** **ENTER** or

**LOAD** 1..5 **SNAPSHOT** # **ENTER**

Loads the currently highlighted SNAPSHOT or one specified by number according to SNAPSHOT Defaults for channels 1-5.

(See page 6-65 for details of how to specify Ranges and Lists)

**LOAD** **TITLE** **ENTER** or **LOAD** **TITLE** # **ENTER**

Loads the appropriate CUES list for the currently highlighted TITLE or one specified by number.

**LOAD** **MIX** **ENTER** or **LOAD** # **MIX** **ENTER**

Loads the currently highlighted MIX, or one specified by number, into memory.

#### **Note:**

*Auto-Saved mixes can be loaded as above. MIX 0 is the most recent whilst MIX -1 and MIX -2 are earlier Auto-Saves.*

Ranges and Lists can be specified when loading Mixes:

**LOAD** 1..5 **MIX** **ENTER** or **LOAD** 1..5 **MIX** # **ENTER**

Loads the currently highlighted MIX or one specified by number according to SNAPSHOT Defaults for channels 1-5.

(See page 6-65 for details of how to specify Ranges and Lists)

### “PLAY” Command Lines

**PLAY** **ENTER**

Plays from the last locate point.

**PLAY** *Timecode* **ENTER**

Plays from a timecode point which is entered using the numeric key-pad.

## 6-3 Central Section Panels

**PLAY** **TITLE** **ENTER** or **PLAY** **TITLE** # **ENTER**

Plays currently highlighted TITLE or one specified by number.

**PLAY** **CUE** **ENTER** or **PLAY** **CUE** # **ENTER**

Plays from the currently highlighted CUE or from CUE #.

**PLAY** **CUE** 3 **CUE** 4 **ENTER**

Plays from CUE number 3 to 4 and stops.

**PLAY** **MIX** **ENTER** or **PLAY** **MIX** # **ENTER**

Plays the currently highlighted MIX or one specified by number.

**PLAY** **A** or **B** **ENTER**

Plays from the timecode locations stored in bookmarks A or B as selected.

**PLAY** **A** **B** **ENTER**

Plays from time location A to location B and stops.

**PLAY** . **ENTER**

Plays from the current timecode minus the 'quick rollback time' (see page 6-73).

### “LOCATE” Command Lines

**LOCATE** **ENTER**

Locates the system to the last location timecode point.

**LOCATE** *Timecode* **ENTER**

Locates the system to a specified timecode location entered using the numeric key-pad.

**LOCATE** **TITLE** **ENTER** or **LOCATE** **TITLE** # **ENTER**

Locates the system to the start of the current TITLE or TITLE #.

**LOCATE** **CUE** **ENTER** or **LOCATE** **CUE** # **ENTER**

Locates to the currently highlighted CUE or CUE #.

**LOCATE** **MIX** **ENTER** or **LOCATE** **MIX** # **ENTER**

Locates to the currently highlighted MIX or one that is specified by number.

**LOCATE** **A** or **B**

Locates the system to timecode locations in set at A or B as selected.

**LOCATE** . **ENTER**

Locates to the current timecode minus the 'quick rollback time' (see page 6-73).

**“CYCLE” Command Lines**

**CYCLE** **TITLE** **ENTER** or **CYCLE** **TITLE** # **ENTER**

Plays and repeats the current or specified TITLE continuously.

**CYCLE** **CUE** # **CUE** ## **ENTER**

Repeatedly plays the passage between CUE # and CUE ##.

**CYCLE** **MIX** **ENTER** or **CYCLE** **MIX** # **ENTER**

Plays and repeats current or specified MIX continuously.

**CYCLE** . **ENTER**

Plays and repeats from the current timecode minus the quick rollback time (see page 6-73).

**“SAVE” Command Lines**

**SAVE** **MIX** **ENTER** or **SAVE** **MIX** # **ENTER**

Saves the WORKING MIX by overwriting the one currently highlighted in the list of mixes or a MIX specified by number.

**SAVE** **MIX** **AS NEW** **ENTER**

Saves the WORKING MIX to a new file for which a default name is created (or the MIX can be named at the time of saving via a pop-up).

**SAVE** **SNAPSHOT** **ENTER** or **SAVE** **SNAPSHOT** # **ENTER**

Saves a SNAPSHOT by overwriting the one currently highlighted in the list of Snapshots or a Snapshot specified by number.

**SAVE** **SNAPSHOT** **AS NEW** **ENTER**

Saves a SNAPSHOT to a new file for which a default name is created (or the SNAPSHOT can be named at the time of saving via a pop-up).

**BACK SPACE** **Key**

Deletes the last command or character entry in the Command Dialogue Line at the bottom of the central LCD.

**“MAKE STATIC” Command Lines**

**MAKE STATIC** **ENTER**

Returns the system to a non-automated manual state allowing a restart with a static mix. The balance will be set depending on where the tape was stopped in the current mix. If there is any unsaved automation data in memory then a pop-up appears in order to prompt saving it.

**MAKE STATIC** # **ENTER**

Removes the moves data from the working mix for channel # for controls according to the Snapshot DEFAULTS in the Snapshots GUI.

## 6-3 Central Section Panels

**MAKE STATIC** # . . # **ENTER**

Removes the moves data from the working mix for a range of channels # . . # for controls according to the Snapshot DEFAULTS in the Snapshots GUI (see page 6-65 for details of how to specify Ranges and Lists).

### “MERGE” Command Lines

**Note:**

*Comprehensive control of “MERGE” functions is available via GUI and is described in Chapter 7.*

MERGE command lines require ranges and/or lists to be specified (see page 6-65 for details of how to specify Ranges and Lists). Mix data can be copied and pasted in the working mix or imported from other mixes. Snapshot settings can also be merged into mixes.

The MERGE Command Line has the general form:

**MERGE** (Source Range/List) from (Specified Start Time) to (Specified End Time) to (New Specified Start Time) **ENTER**

Times can be specified in various ways: **A**, **B**, **CUE**, **CUE** # or typed in using the numeric keypad on the Control Keyboard. Where timecode is typed in, a blank  or **TO** key must be used between numbers as a separator. Examples:

**MERGE** 1..48 **MIX** **CUE** 3 **CUE** 6 **CUE** 9 **ENTER**

Adds a new automation layer to the working mix that copies all the moves for channels 1-48 between Cue 3 and Cue 6 to repeat starting at Cue 9.

**MERGE** 1..2 **SNAPSHOT** **A** **B** **ENTER**

Adds a new automation layer to the working mix that will switch to the currently highlighted Snapshot settings at point A and back to existing data at point B for channels 1 and 2.

**MERGE** 01..032 **MIX** #  2:00 **TO** 4:00 **TO** 2:00 **ENTER**

Adds a new automation layer to the working mix that will switch to the Control Group Faders move data for Mix # between 2:00 and 4:00 minutes.

### “PROJECT” Command Line

**PROJECT** **ENTER**

Creates a new Project.

### “TITLE” Command Line

**TITLE** **ENTER**

Creates a new Title.

## “CUE” Command Line

**[CUE] [ENTER]**

Creates a new Cue in the CUES list at the current time for the master machine. A pop-up appears allowing a name to be assigned to the new Cue. Click on **[ENTER]** or click on OK for the next default Cue number or type in a name using the QWERTY Keyboard first.

## “MIX” Command Lines

MIX Command Lines are related to Audition functions within the Mix Automation. See section 7-7 for details.

## Other Command Key Functions

**[SELECT MACH] Key**

Allows machines other than the Timecode Master to be controlled by the system Transport Control. Once the **[SELECT MACH]** key has been pressed, pressing any Transport Remote button on any machine causes the system to control that machine until another is selected in the same way.

**[JOG] Key**

Displays the current Jog function in the Command Dialogue Line and allows its other functions to be set. See page 6-63 for details.

### ▲ and ▼ Keys

Are tab and back-tab functions to move the orange highlight around the various fields within GUIs.

**↑, ⇐, ≥ and ÷ Keys**

Allow the orange highlight to be moved around in the current field.

**[TO] & [AS NEW] Keys**

Are used specifically in conjunction with other command lines described previously within this section.

**[NOW] Key**

Allows the current time point to be set on a timecode pop-up or list entry which is highlighted orange.

**[+] & [-] Keys**

Allow a timecode entry, which is highlighted orange, to be nudged up or down in frames. This applies to timecode pop-ups too except that the category to be nudged, hours, minutes, seconds or frames, can be selected using the ⇐ and ÷ keys.

**[EDIT] Key**

To use the EDIT function, move the orange highlight to the desired entry, then touch the **EDIT** key to display a pop-up Dialogue Box.

## 6-3 Central Section Panels

---

### “A” & “B” Command Lines

**A** **ENTER** & **B** **ENTER**

Create convenient temporary Cue points displayed in the CUES list; useful for commands such as:

**LOCATE** **A** or **B**

Locates the system to timecode points set for Cue A or B.

**PLAY** **A** **B**

The system plays from Cue point A to Cue B and stops.

**CYCLE** **A** **B**

The system plays from Cue point A to Cue B then rewinds and repeats the passage between A and B continuously until stopped by pressing either

**CANCEL** or the **■** transport key.

The A and B Cue points may be revised at any time.

**CANCEL** **Key**

Cancels the current command. It will also delete commands on the Command Line prior to pressing **ENTER**.

**REPEAT** **ENTER**

This key sequence repeats the last-entered command. To access earlier commands, press **REPEAT** the relevant number of times (up to a maximum of 40). The stored command is displayed at each press. The command will be executed when **ENTER** is pressed.

### Using the Numeric Key-pad to Enter Timecode

The entry format is exactly the same as that used for PCM-3324/48 series remote control units:

1	=	00:00:01:- -
12	=	00:00:12:- -
1234	=	00:12:34:- -
12345	=	01:23:45:- -
123456	=	12:34:56:- -
12345621	=	12:34:56:21
12:34:56:21	=	12:34:56:21
12:34:56	=	12:34:56:- -

### Timecode shortforms:

::	Separates hours/minutes
:	Separates minutes/seconds
.	Separates seconds/frame

12::	=	12:00:00:00	Specifies hours
34:	=	00:34:00:00	Specifies minutes
56	=	00:00:56:00	Specifies seconds
.21	=	00:00:00:21	Specifies frames

### Example:

3:4 = 00:03:04:00 (Any combination is allowed)

### To set and use 'QUICK ROLLBACK'

Press . # **ENTER**, where # = the rollback time in seconds. To 'quick rollback' on the machine transport keys, press and hold **PLAY** and press **STOP** for an instant. See also **PLAY**, **LOCATE**, and **CYCLE**.

## 6-3 Central Section Panels

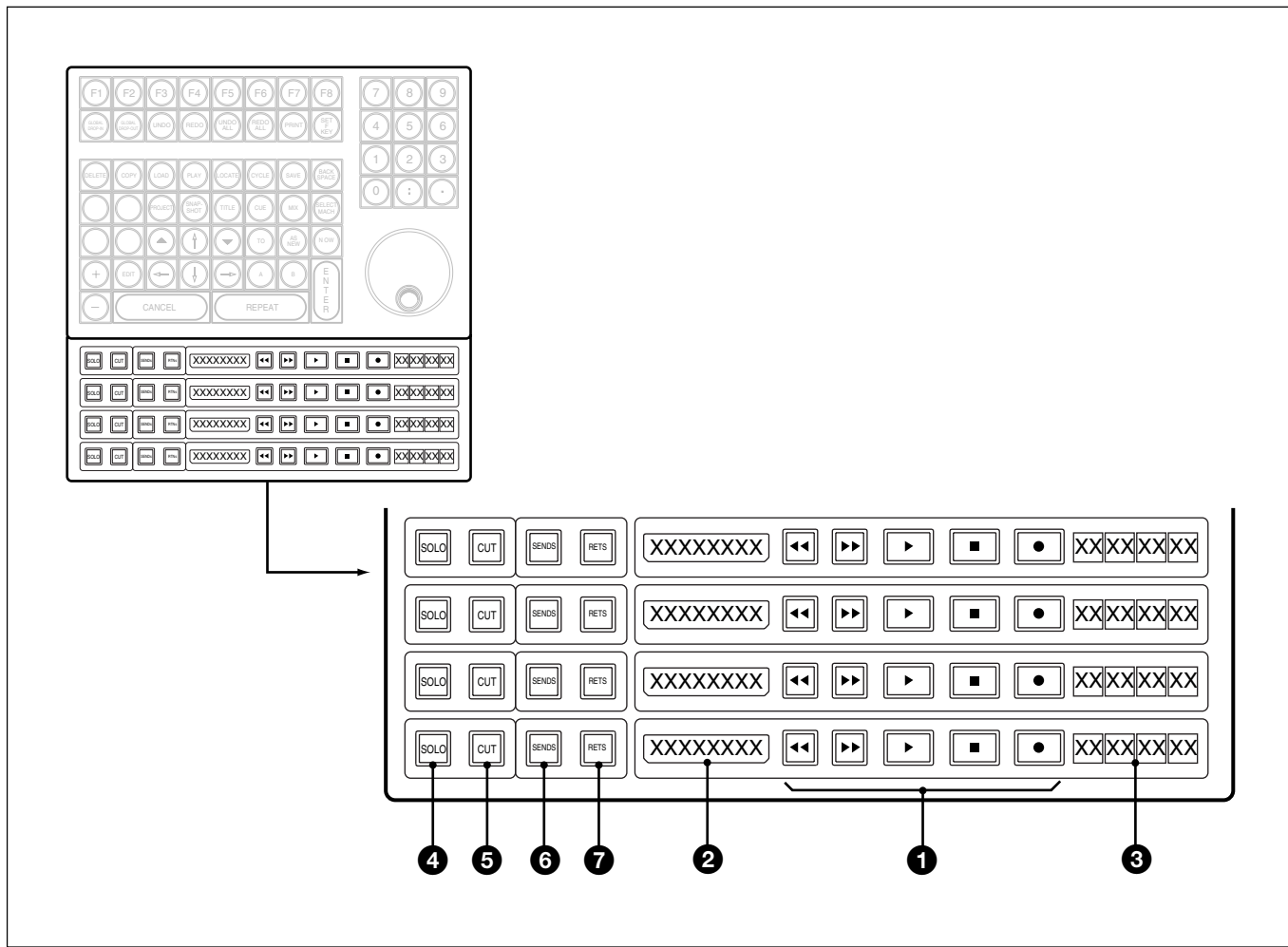

### Tape Remotes

The assignment of machines to Tape Remotes is accomplished using the MACHINE REMOTES GUI in the Session Management & Dynamic Automation system. Each set of remotes may be assigned to an individual machine.

- ❶ Transports Push-Buttons**  
 Are marked and function according to international standards.
- ❷ 8 Character Displays**  
 To the left of the Tape Remotes, display the machine names or numbers, as assigned in the Machines GUI.
- ❸ 8 Character Displays**  
 To the right of the Tape Remotes, and divided into 2-character blocks, indicate timecode positions for their particular machines.



**4 SOLO Push-Buttons**

Allow grouped Solo function according to the groups set up. See **6** and **7** below.

**5 CUT Push-Buttons**

Allow grouped Cut function according to the groups set up. See **6** and **7** below.

**6 SENDS Push-Buttons**

Select the channel signal being sent to the M/T as monitor source. May be linked to control SEND buttons on Pans panels as groups (see section 6-2-3); hold down this button (it will flash) then select SEND(s) on the channels that are required to be grouped. Latching SENDS will set all SEND buttons in the group.

**7 RETS Push-Buttons**

Select the return signal from the M/T. May be linked to control RET buttons on Pans panels as groups (see section 6-2-3); hold down this button (it will flash) then select RET(s) on the channels required to be grouped. Latching RETS will set all RET buttons in the group.

**Note:**

- 1 *Setting up a group with either SENDS or RETS will cause the group to be set for channel SENDs, RETs, SOLOs and CUTs.*
- 2 *The grouping function is not operable in Multi-Format mode if any of these buttons sets are assigned to control the monitor switching of a Stem or number of Stems (see sections 4-13-4 and 4-13-5).*

**Using Keyboard Entry to Record Arm Channel Tracks**

Press **RECORD** at the appropriate machine remotes in the master section. Then use the QWERTY Keyboard: *Specify Channels as Below* **ENTER**

- Channels ranges are specified with ‘..’ as a separator:

1..32 = Channels 1-32

- Individual items are separated by ‘.’

2 . 4 . 25 = Channels 2, 4, and 25

- Unlimited strings are possible in the same entry:

e.g. 1 . 3 . 5 .. 08 . 12 .. 42 = Channels 1, 3, 5-8 and 12-42

Track arming using the keyboard is not additive and must be accomplished using a single entry. In other words the latest entry overwrites the previous one.

Press **RECORD** **0** **ENTER** to disarm all the tracks that are armed.

## 6-3 Central Section Panels

### 6-3-4 Super Send Groups, Send Outputs and Multi-Format Panel

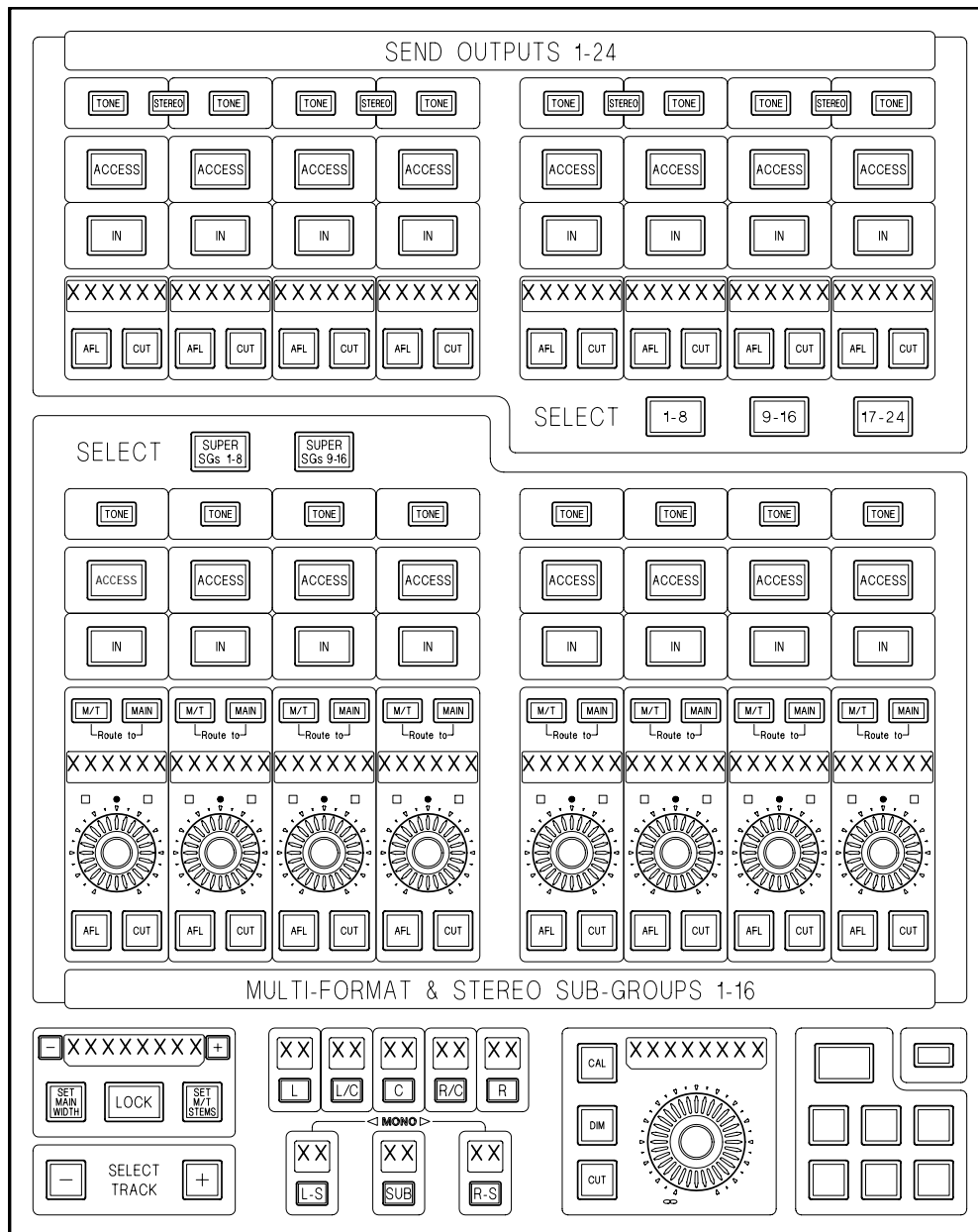
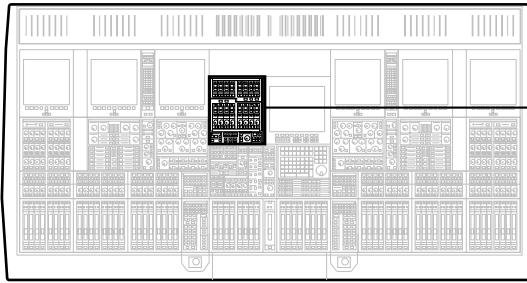

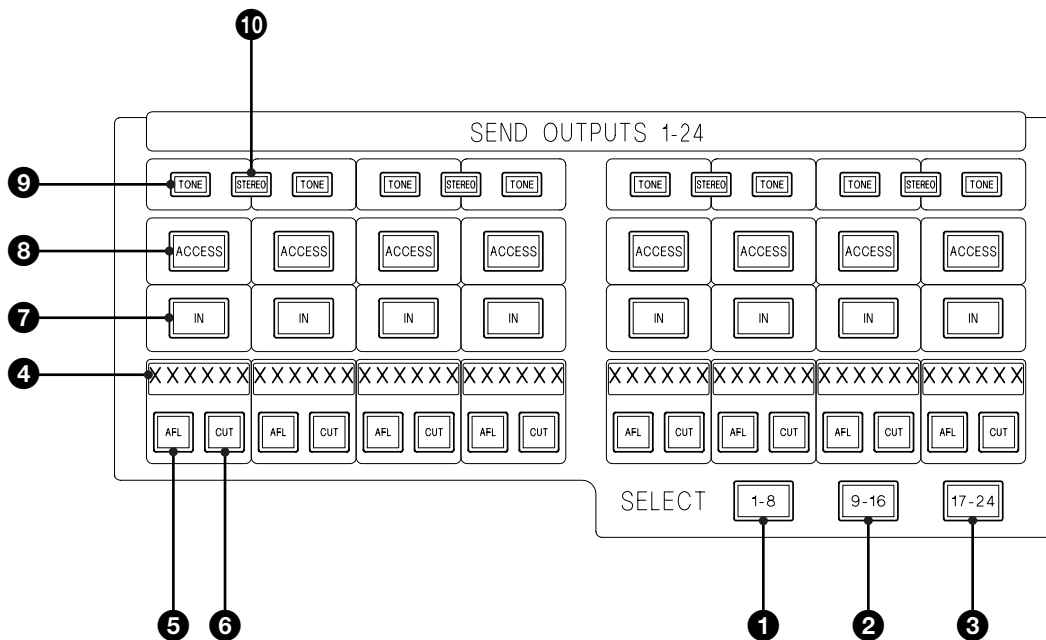
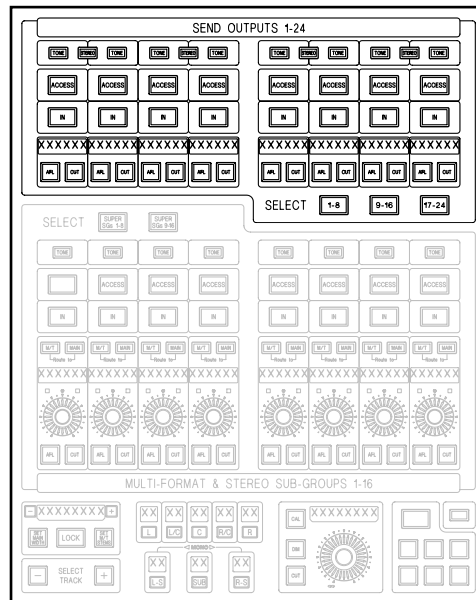

### SEND OUTPUTS 1-24 panel section

This section of the panel allows control of up to 24 Send Outputs in blocks of eight 1-8, 9-16 and 17-24.

The default gain setting for the Send Outputs is unity or 0dB. They do not have gain controls in their panel area but their output level can be adjusted using the multi-purpose faders in the centre section (described in section 6-2-2).

## 6-3 Central Section Panels

---

### ❶ 1-8 Push-Button

Assigns Sends 1-8 to the control panel.

### ❷ 9-16 Push-Button

Assigns Sends 9-16 to the control panel.

### ❸ 17-24 Push-Button

Assigns Sends 17-24 to the control panel.

### ❹ 6 Character Display(s)

Indicates Send number or signal name defined in the 'Send Outputs' page of the MASTER GUI (see section 5-2-6 in Chapter 5).

### ❺ AFL Push-Button(s)

Sends the After Fader Listen signal to CR monitor LS. Becomes destructive SOLO-IN-PLACE in Multi-Format Calibration mode.

### ❻ CUT Push-Button(s)

Mutes the signal post Level control.

### ❼ IN Push-Button (Not operational in this version)

Switches in any processing elements selected using ACCESS.

### ❽ ACCESS Push-Button

Selects MIDI pages, one of 1-8, 9-16 or 17-24, depending on which Sends page is selected. The MIDI GUI is selected from the SENDS GUI which is found in the MASTER GUI.

### ❾ TONE Push-Button

Enables Tone from the oscillator to be injected into a Send output post the level control, in place of signals routed to that Send.

#### Note:

*The oscillator must be switched on at the Oscillator section before the Send TONE button will function.*

### ❿ STEREO Push-Button

Links its odd/even pair of SENDs as a stereo output so that AFL, CUT and level functions are ganged. The stereo function is propagated through to the channels such that the appropriate Send sections are automatically set up for stereo operation.





## SUPER SEND GROUPS (SSGs) 1-16 panel section

The SSGs can be configured flexibly in a number of combinations:

- Mono
- Stereo
- LCR
- LCRS
- 5.0
- 5.1
- 7.0
- 7.1

Any groups that are set up cannot span across the two pages, 1-8 and 9-16. Any group must consist only of consecutively numbered SSGs.

### ❶ SUPER SSGs 1-8 Push-Button

Assigns SSGs 1-8 to control section.

### ❷ SUPER SSGs 9-16 Push-Button

Assigns SSGs 9-16 to control section.

### SSG set-up procedure

The fire-up default for the 16 SSGs is 8 Stereo but they can be flexibly set up in a great many combinations.

- 1** Press and hold the **ACCESS** button **10** and it will turn amber. Simultaneously, **ACCESS** buttons of any other SSGs in the same group will light amber.
- 2** To add to the group, whilst still holding the **ACCESS**, press the next **ACCESS** button at the end of the group or the **ACCESS** before the first SSG in the group if appropriate.
- 3** To make the group smaller, whilst still holding the **ACCESS**, press a lit **ACCESS** button which is either the first or last of the group to de-select it from the group.

#### Note:

*Adding an SSG to a group will 'steal' it from its current group, without warning, if it happens to be set up that way.*

### Level and Pan settings

The signal level sent from a channel to an SSG is exactly the same as feeds the Main Output Bus. The Pan settings are the same too except that it is possible to have an SSG which is set up to be 'wider' than the Main Output Bus.

In other words, the Main Output could be set up for Stereo for example, whilst one of the SSGs might be set for 5.1. The panner creates full surround information at all times which would be fed to the 5.1 SSG. But the Stereo Main would receive the full signal based on L/R Pan settings only.

### 3 Level Knob(s)

Controls signal output level for its Super Send Group.

### 4 6 Character Display

Indicates Send Group number or signal name as defined in the MASTER page which is available on any of the Channels LCD screens.

### 5 AFL Push-Button(s)

Sends After Fader Listen signal to CR monitor LS.

### 6 CUT Push-Button(s)

Mutes the signal post Level control.

#### Note:

*SSG Level controls, and buttons are linked as a fire-up default. These controls can be optionally un-linked according to settings in the Config-File set-up.*

### 7 M/T Push-Button(s)

Routes its SSG output to M/T routing for 'bounce-down'. The SSG **ACCESS** button must be selected to gain access to channel M/T routing buttons for track assignments. Then select one (or more) buttons in the ROUTE TO TRACKS section at the Routing panel.

### 8 MAIN Push-Button(s)

Routes its SSG output to feed the MAIN L/R output busses. The SSG **ACCESS** button must be selected to gain access to channel routing buttons. Then select (one more) of the surround routing buttons in the MULTI-FORMAT section at the Routing panel.

### 9 IN Push-Button(s)

Switches its SSG Insert into the signal path. (Refer to Chapter 5 for details of SSG Insert I/O assignments).

### 10 ACCESS Push-Button(s)

Assigns SSGs to the routing panel.

### 11 TONE Push-Button(s)

Enables Tone from the Oscillator to be injected into its SSG output, post the level control, in place of signals routed to that SSG.

#### Note:

*The oscillator must be switched on at the oscillator section before the SSG TONE button will function.*





### ③ SET M/T STEMS Push-Button

Allows the format of the Multitrack Stems to be set: STEREO, LCRS, 5.1 or 7.1 using the  and  buttons either side of the 8 character dot display, which indicates the current format. The  function is locked unless  has been pressed to unlock it first. It inter-cancels with the  button.

With  set and  lit, indicating lock status, the  and  buttons can be used to step through Stems A-H, indicated by the letter at the right in the 8 character display. Set-up settings relating to each Stem will be displayed accordingly, in other sections of this panel.

### ④ + / - Push-Buttons (either side of character display)

Enable the appropriate format to be selected for the Main Output Bus and Multitrack Stems, depending on whether  or  is selected.  must be pressed first to unlock the set-up facility.

### ⑤ 8 Character Display

Indicates the format selected STEREO, LCRS, 5.1 or 7.1 and stem, one of A-H.

### ⑥ L, L/C, C, R/C, R, L-S, SUB and R-S Push-Buttons (each with track number display)

These buttons, combined with the  and  push-buttons ⑦, allow assignment of surround routing buttons, in the MULTI-FORMAT section of the Routing panel, to the Multitrack Busses in order to set up Stems. (The set-up procedure is described in detail in Chapter 4).

To make an assignment, unlock , then press and hold the desired destination ,  etc. Step through the tracks with the  and  buttons ⑦, until the desired track number is displayed in the two character display. Release the destination button. Press  to re-lock the set-up or allow it to time out.

### ⑦ + / - Push-Buttons

Combined with the buttons described in ⑥, these buttons allow toggling through the Multitrack routing bus numbers in order to set up Stems using the Multitrack Busses.

### ⑧ ⑨ Monitor Level Knob & 8 Character Display

Controls the overall level to the Control Room Monitor LS level when  is not selected. This control operates in parallel with the Monitor Level on the Monitor panel.

The 8 Character Dot Display indicates level setting in dB SPL including calibrated settings. When  is selected, push and rotate to define a new calibration setting. CAL MODE in the PREFS GUI must be set to 'ON' in order that the calibrated settings are active.

---

**Note:**

The **CAL** indications are accurate only if the Calibration Procedure has been carried out as described in Appendix A-3.

**10 CAL Push-Button**

Fixes the monitor level to the current calibration setting. The knob is not operational when **CAL** is selected.

**11 DIM Push-Button**

Dims all monitor LS outputs according to the dim level setting. Operates in parallel with the **DIM** button on the Monitor panel.

**12 CUT Push-Button**

Cuts all the Monitor LS outputs. Operates in parallel with the **CUT** button on the Monitor panel.

## 6-3 Central Section Panels

### 6-3-5 Central Section Faders

The two banks of 8 Faders in the console centre section are identical to the faders used in the channel sections of the control surface.

*(Refer to Section 6-2-1 in this chapter for details of the Fader Modules)*

Assignment of these central Multi-purpose Faders is effected from the **SEL** push-buttons at the Select To Faders Select panels.

*(Refer to Section 6-2-2 in this chapter for details of the Select To Faders modules)*

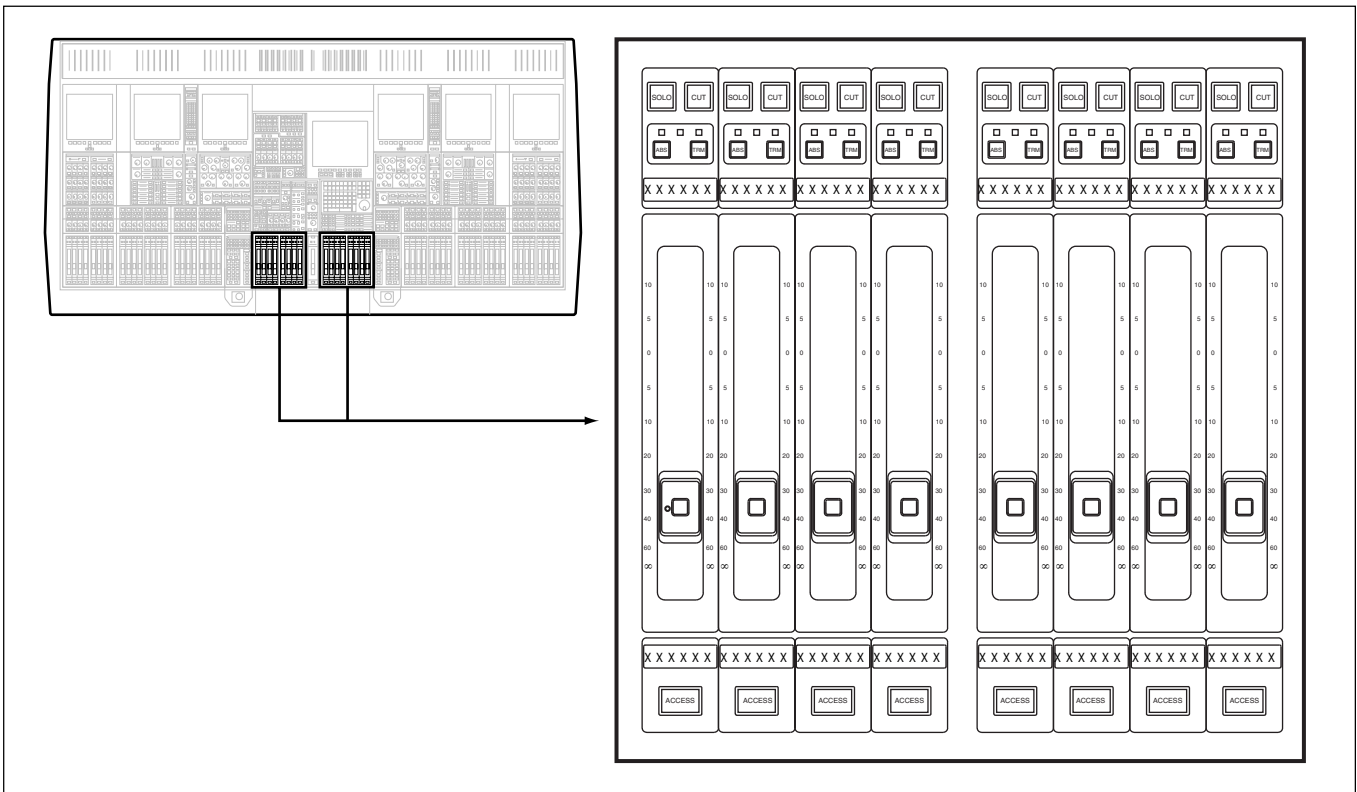

Central section Multi-purpose Faders

#### Control Groups and Slaves

Press and hold **ACCESS** on a central Control Group Fader until it turns amber. Latch **ACCESS** on the channel faders to be slaved. A maximum gain of 10dB can be added to a channel using a Control Group.

Use the same procedure to release slaves except that, once the Control Group **ACCESS** has turned amber and its slave **ACCESS** buttons are lit, un-latch the slaves as required.

#### Nested Control Groups

Control Groups can be slaves to other Control Groups without limits except that they must have hierarchies. Circular routes are blocked. They are set up using their **ACCESS** buttons in exactly the same way as channel faders are set as slaves.

## 6-3-6 Control LCD Screen Panel

Contains a 10.4 inch colour TFT LCD VGA screen. It displays major System Set-up details and all the Session Management™ information relating to dynamic automation, including screens for Projects, Titles, Mixes, Snapshots and Track Lists etc.

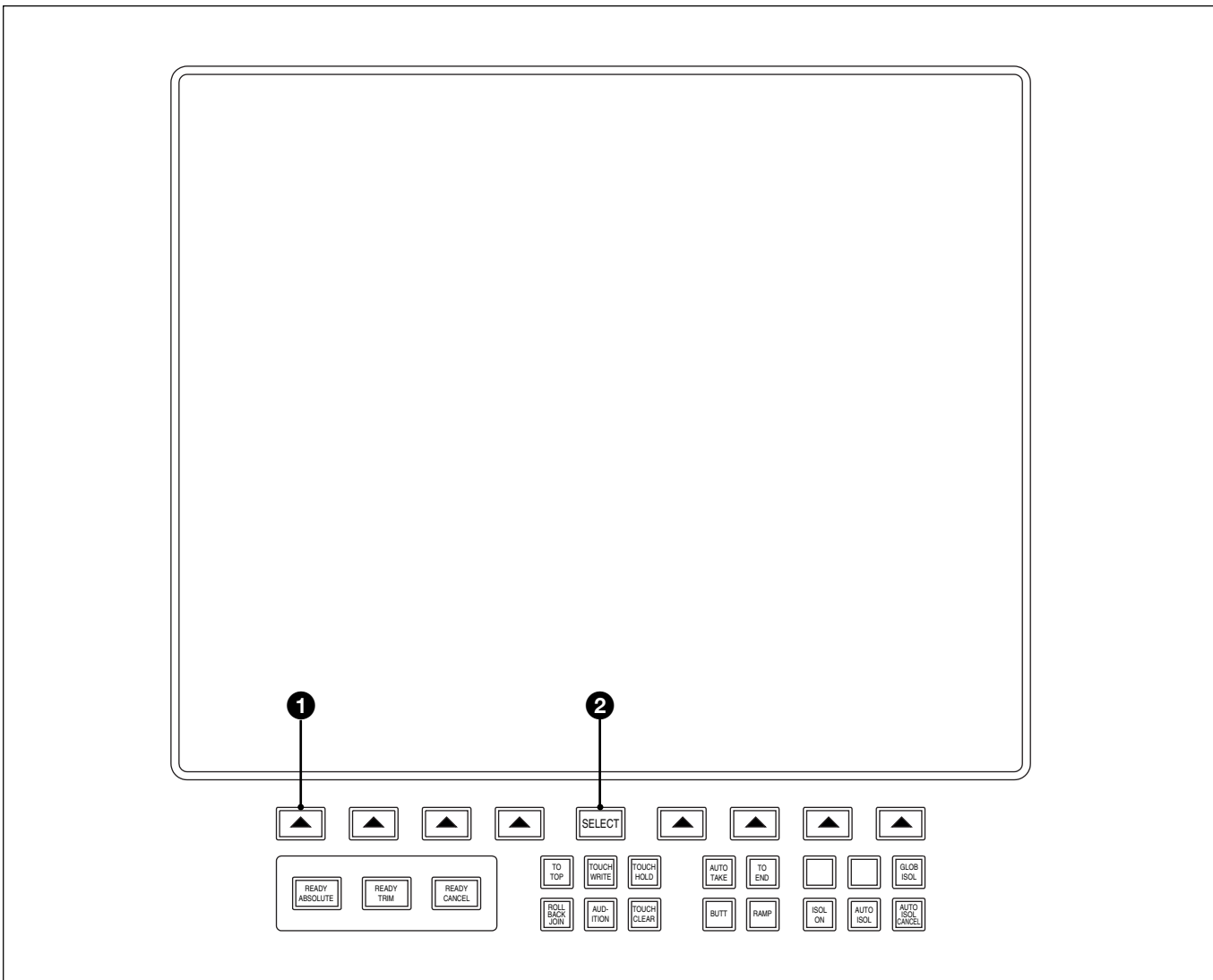

Control LCD Screen panel

### ❶ ▲ Push-buttons (x 8)

Allow screen pages to be selected as indicated on labels within the screen area above each button.

### ❷ SELECT

Selects the cursor to the centre of the LCD screen

All other push-buttons are related to the Dynamic Automation described elsewhere in this manual. (Refer to Chapter 7 for details).

## 6-3 Central Section Panels

### 6-3-7 QWERTY Keyboard

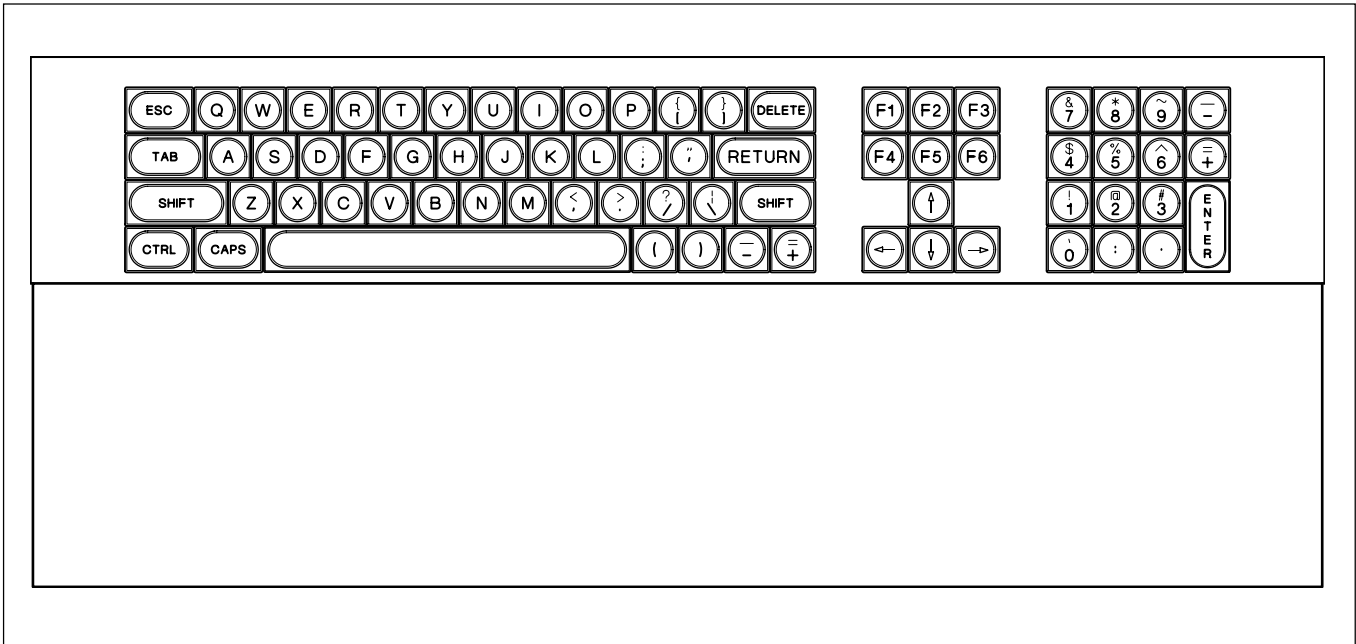

#### QWERTY KEYBOARD

The QWERTY Keyboard, used to type in specific names for Titles, Cues and Tracks, etc., is conveniently housed at the front of the centre section of the OXF-R3 console. A protective sliding cover, pulled towards the operator when the keyboard is in use, doubles as a palm rest when typing.

## 6-3-8 Trackerballs

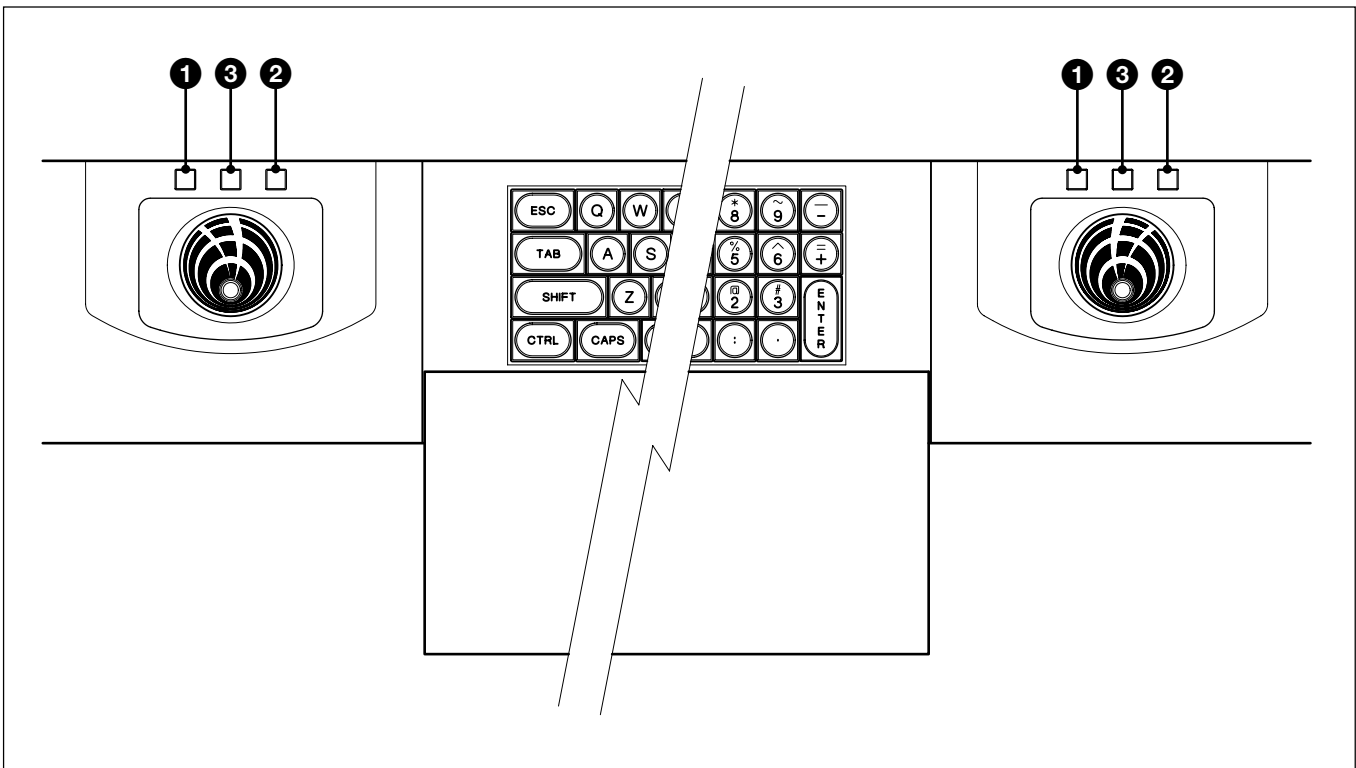

### TRACKERBALLS

There are two Trackerball pointing devices to allow easy operation for left- or right-handed personnel. They can both control the same cursor/pointer which can be moved into any screen on the OXF-R3 control surface. It is possible to split the control in order that the left Trackerball controls the three LCDs in the left channels section, and the right Trackerball controls the three LCDs in the right channels section, plus the central LCD. See the PREFERENCES GUI on the central LCD and click on the POINTER tab to change the operation.

#### ❶ Move Cursor Left Push-Buttons

Cause the Cursor to jump one screen left for each press.

#### ❷ Move Cursor Right Push-Buttons

Cause the Cursor to jump one screen right for each press.

#### ❸ Action Push-Button

Press to action the function or button beneath the cursor, or cause a pop-up be displayed where appropriate.

# 6-4 Meter Bridge

The standard meters used on the Meter Bridge of the OXF-R3 are a bargraph type utilising back-lit LCD technology with digital scales.

## 6-4-1 Mono Channel Meters

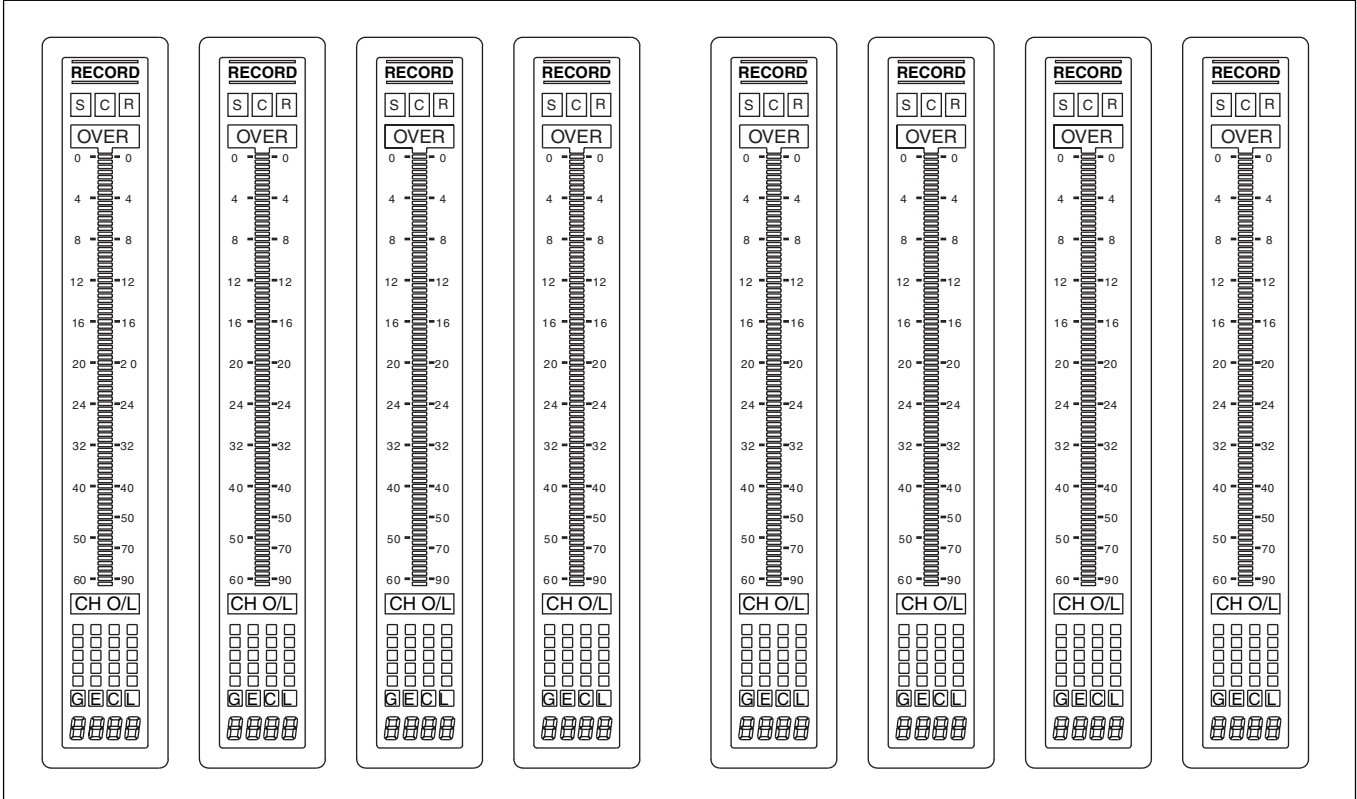

MONO Channel Meters block

Channel meters are fitted, one per channel fader, in blocks of eight. Each meter block is situated directly above a channel's LCD screen. This layout enables channel related information, such as routing assignments which are also displayed in blocks of eight, to line up with their associated meters.



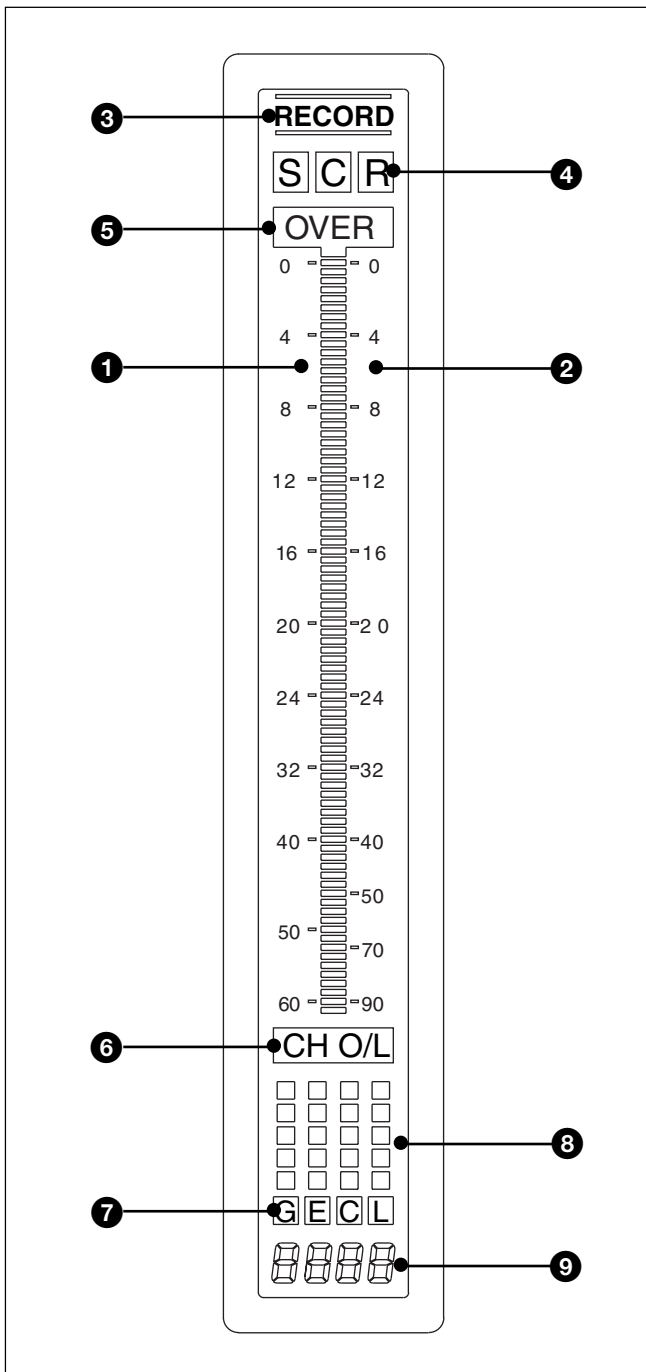

Mono meter

**1 Left Scale**

-60dB - 0dB Full Scale

**2 Right Scale**

-90dB - 0dB Full Scale. This is a more specialised scale which allows monitoring of lower level noises such as air-conditioning.

**3 RECORD Legend**

This follows the channel Record switch function.

**4 S Legend**

Indicates that the meter is reading the SEND Monitor signal.

**C Legend**

Indicates it is reading the CHANNEL Pre Fader signal.

**R Legend**

Indicates it is reading the RETURN Monitor signal.

**Note:**

*These legends are not lit when MTRs to INPUT is selected (see section 6-3-2).*

**5 OVER Legend**

Indicates a digital signal greater than full scale at the pre-fader stage.

**6 CH O/L Legend**

Indicates an overload within the channel signal at the input stage.

**7 G Legend**

Indicates that the dynamics GATE function is selected.

**E Legend**

Indicates that the dynamics EXPANDER function is selected.

**C Legend**

Indicates that the dynamics COMPRESSOR function is selected.

**L Legend**

Indicates that the dynamics LIMITER function is selected.

**8 5 Segment Bar Meters (Not in this version)**

The 4 mini bar meters rising vertically above G, E, C and L legends give a lower resolution display of the channel gain reduction meters.

**9 4 x Seven Segment Characters**

Indicate the channel number for meter signals being displayed.

## 6-4-2 Stereo Centre Section Meters

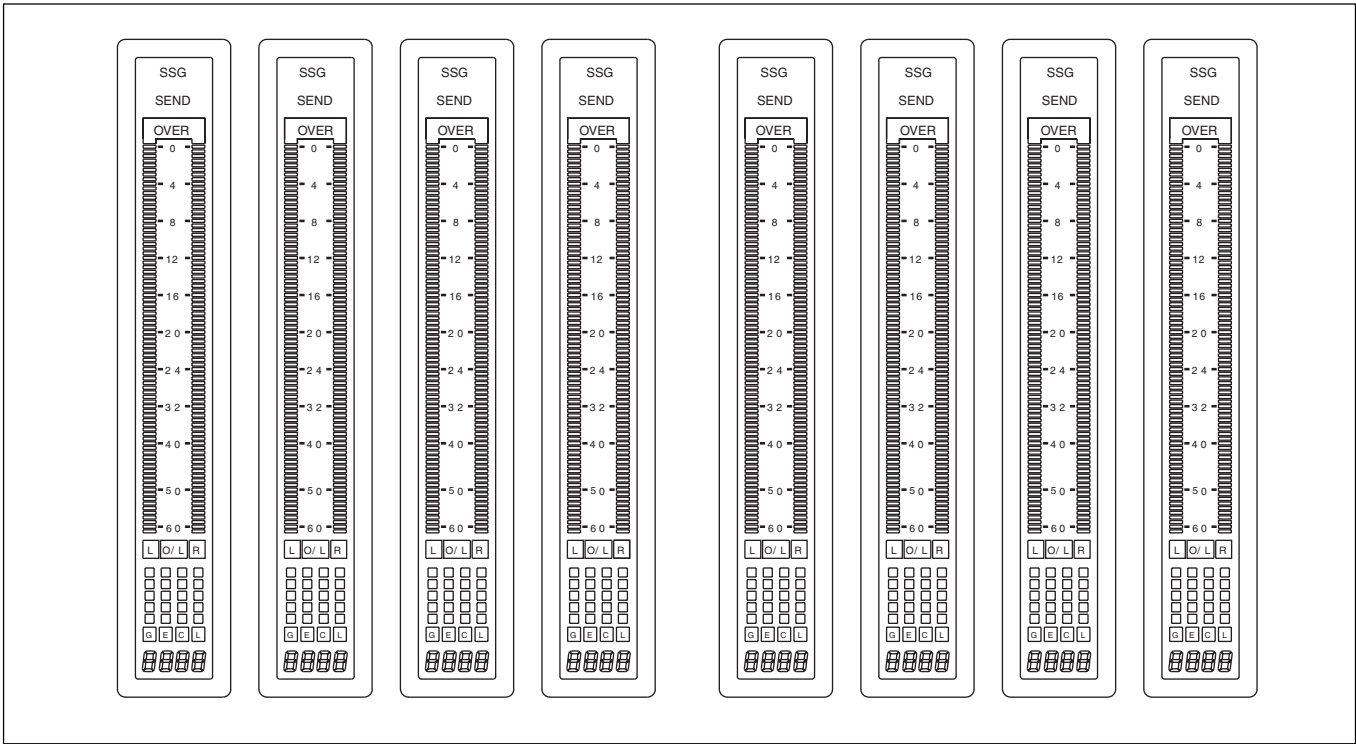

SUPER SEND GROUPS and SEND OUTPUTS Meters block

### CENTRE SECTION METERS

The meters in the centre section consist of two sets of 8 stereo meters, one set each side of a central stereo meter. They can be switched to monitor a number of sources and their function also depends on whether the Main Output Bus is set for Stereo or Surround operation.

#### Left set of 8 Meters

The left hand 8 meters will display the output levels of SSGs 1-16 and Sends 1-24 according to the meter selector on the Monitor panel, described in section 6-3-2. This is irrespective of whether Stereo or Surround is in operation.

#### Right set of 8 Meters

The sources for the right hand 8 meters depend on whether the Main Output Bus is set for Stereo or Surround:

- **Stereo Main Output**

Indicate output level for SSGs 1-16 and Sends 1-24 according to the meter selector on the Monitor panel, described in section 6-3-2.

- **Surround Main Output**

Indicate output levels for the Main Output Bus.

### Central Stereo Meter

The source for the Central Stereo Meter is dependent upon whether the **MAIN** or **FOLLOW MONITOR** is selected under the METERS heading at the top right of the central monitor panel:

- **MAIN**

Can indicate the L and R signals from the Main Output Bus or L and R from the Fold-Down Matrix. This option is set in the PREFERENCES GUI described in section 5-2-5.

- **FOLLOW MONITOR**

Indicates the L and R signals from the Main Output Bus or the L & R signals selected as monitor sources for the CR Monitor LS.

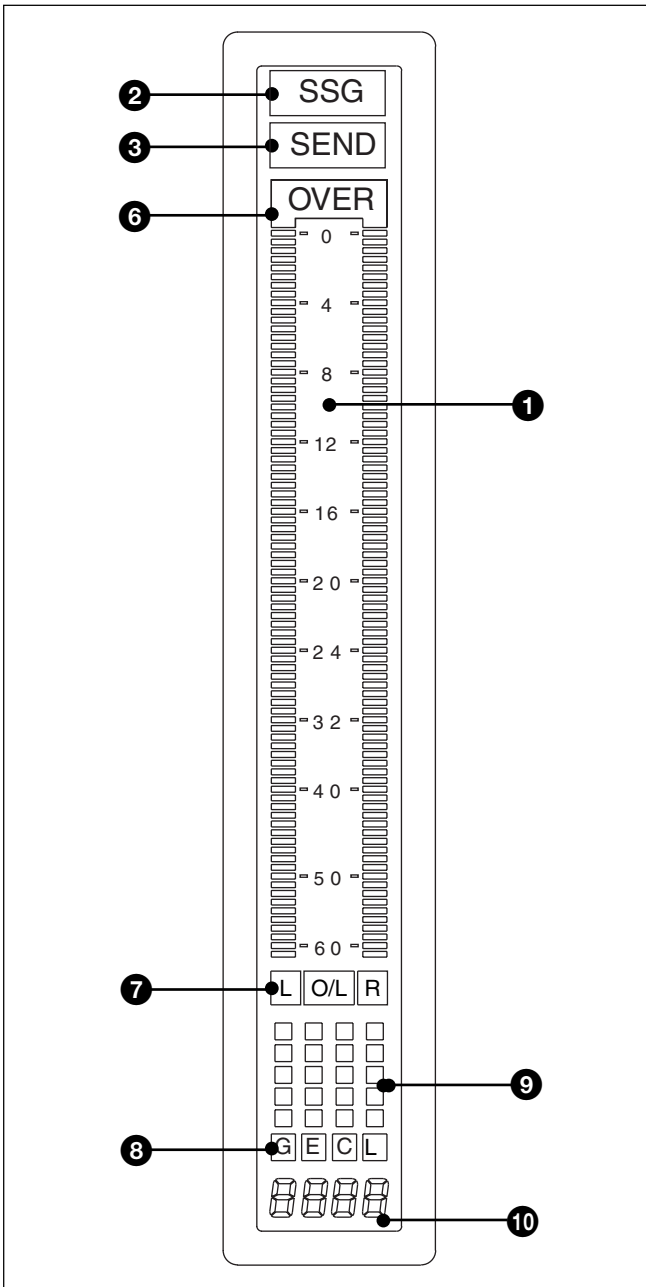

Stereo Meters for SUPER SEND GROUPS and SENDS

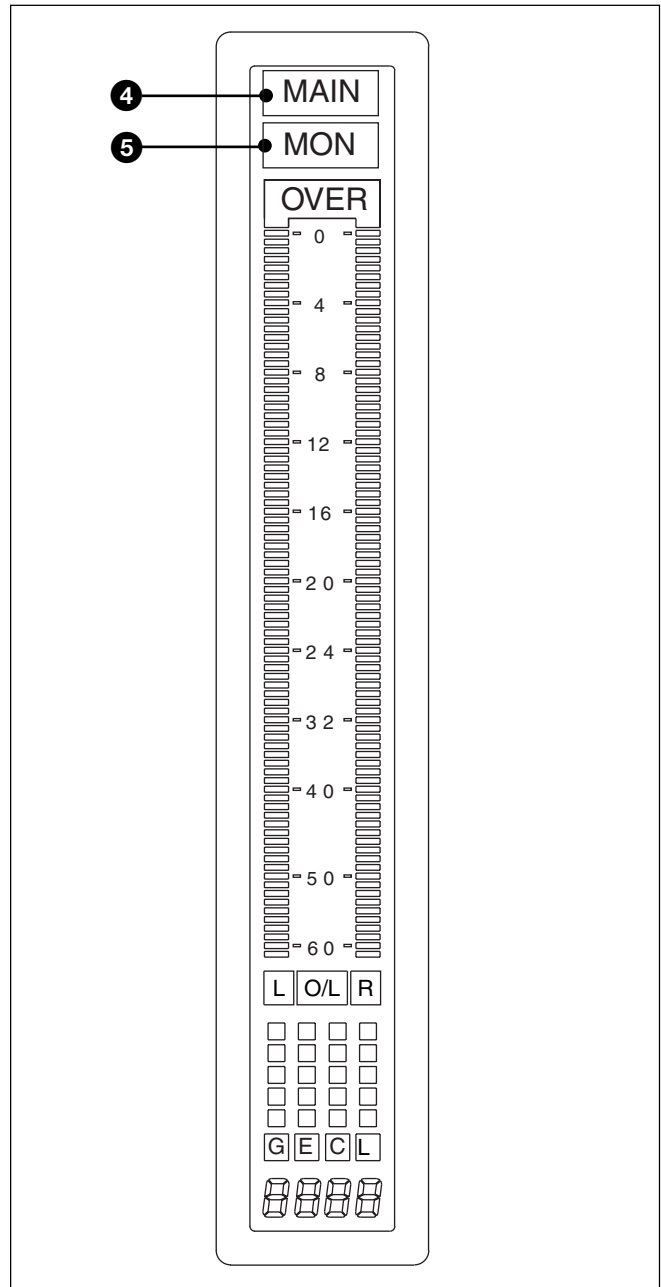

Central Stereo Meter

- 1 Scale**  
-60dB - 0dB Full Scale.
- 2 SSG Legend**  
Indicates a SUPER SEND GROUP meter signal.
- 3 SEND Legend**  
Indicates a SEND Output meter signal.

- 4 MAIN Legend (Central Meter)**  
Indicates that the Central Stereo Meter is locked to the L and R signals of the Main Output Bus.
- 5 MON Legend (Central Meter)**  
Indicates that the Central Stereo Meter will follow all centre section monitor selections.
- 6 OVER Legend**  
Indicates a digital signal greater than full scale.

## 6-4 Meter Bridge

---

### ⑦ L O/L Legends

Indicate an overload pre the fader for the bus feeding the left column of the meter, or light simultaneously with the “OVER” legend at the top of the meter if the source does not relate to a bus.

### O/L R Legends

Indicate an overload pre the fader for the bus feeding the right column of the meter, or light simultaneously with the “OVER” legend at the top of the meter if the source does not relate to a bus.

### L O/L R Legends

Indicate an overload pre the fader for the busses feeding both the left and right columns of the meter, or light simultaneously with the “OVER” legend at the top of the meter if the sources do not relate to busses.

### ⑧ G Legend (Not operational in this version)

**E Legend (Not operational in this version)**

**C Legend (Main L/R only)**

Indicates that the dynamics COMPRESSOR function is selected.

**L Legend (Not operational in this version)**

### ⑨ 5 Segment Bar Meters

The 4 mini bar meters rising vertically above G, E, C and L legends give a lower resolution display of gain reduction (only ‘C’ mini bar meter operational for the Main L/R in this version).

### ⑩ 4 x Seven Segment Characters

Indicate the SSG or SEND number according to the meter signals being displayed.

## 6-4-3 Other Meter Bridge Indicators

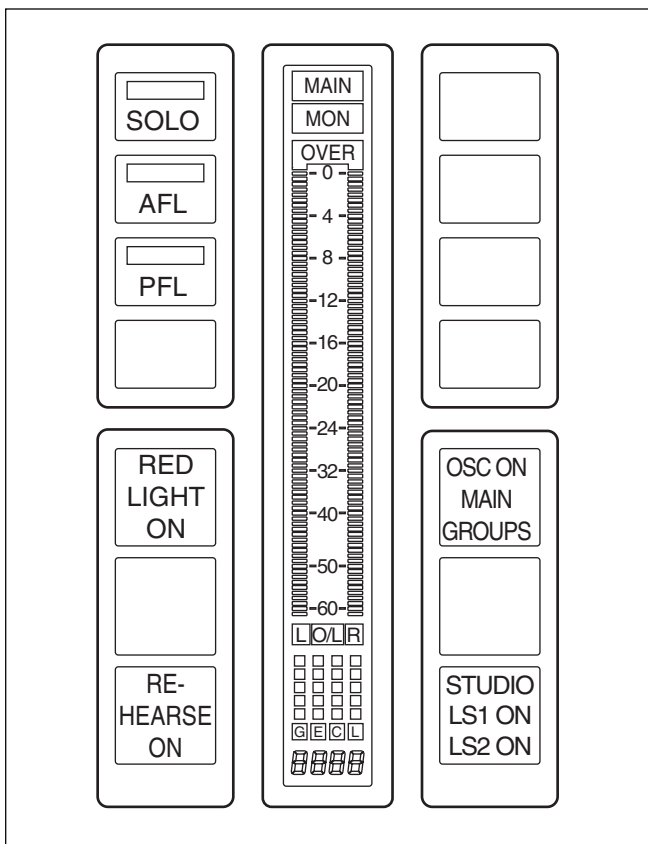

Central Stereo Meter with additional flags

### SOLO and AFL

To the left of Main L/R meter, SOLO or AFL legends indicate the current mode. Larger rectangular flags illuminate to indicate an active function.

### RED LIGHT ON

The Red Light function has an ON indicator situated to the middle left of the Central Stereo Meter.

### REHEARSE ON

The Rehearse function has an ON indicator situated to lower left of the Central Stereo Meter.

### OSC ON (MAIN, GROUPS)

The Oscillator has ON, MAIN and GROUPS indicators situated to the middle right of the Central Stereo Meter.

### STUDIO (LS1 ON, LS2 ON)

The Studio LS switching has Studio LS1 and LS2 indicators situated to the lower right of the Central Stereo Meter.

## 6-5 Signal Processing Rack

The Signal Processing (SP) Rack is one standard size for all OXF-R3 installations.

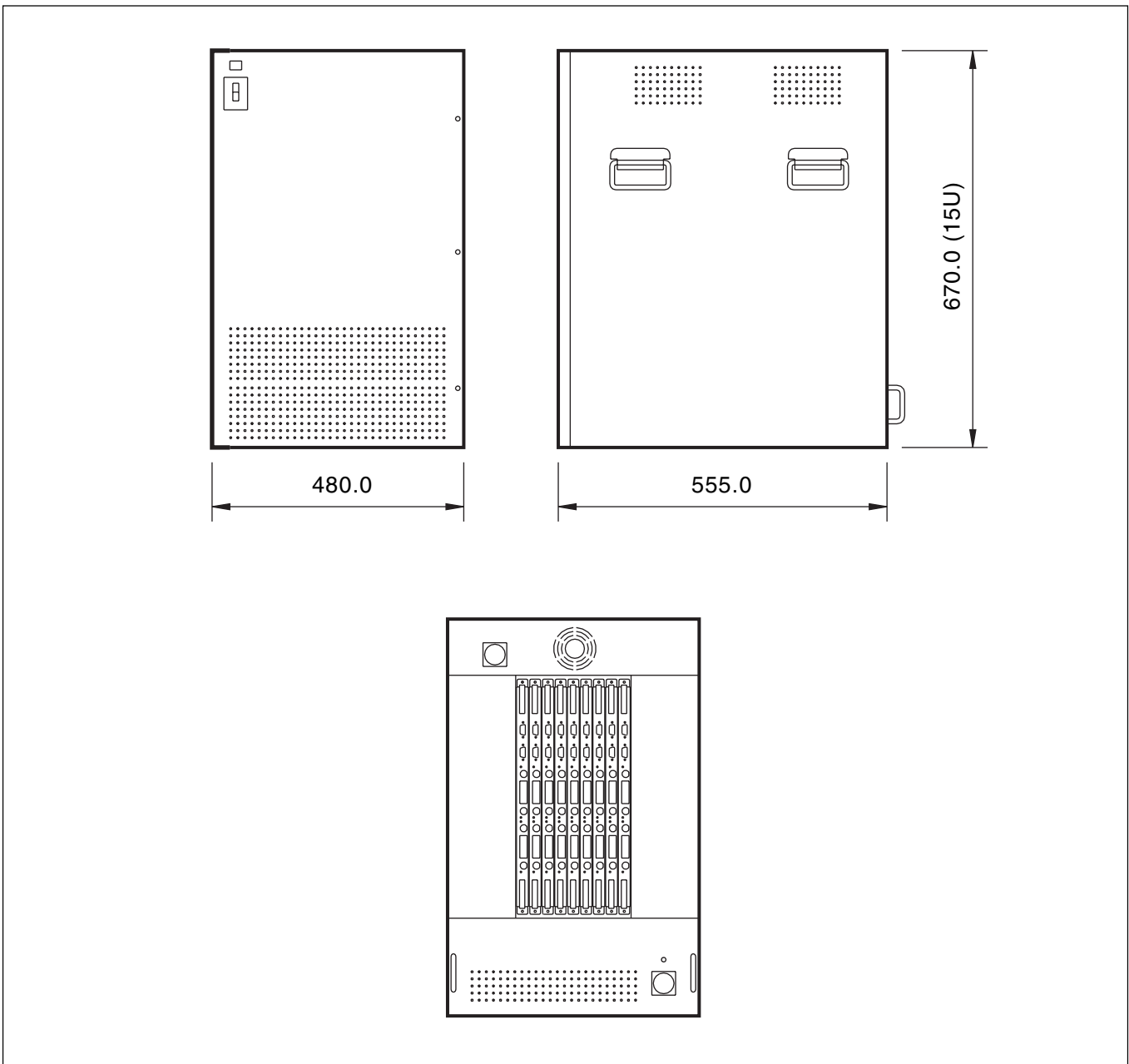

SP Rack

### 6-5-1 SP Rack Modules

The SP rack contains the following modules:

- 1 x SP Buffer Module - Interface between SP rack and host computer.
- Up to 4 x SP Link Module - Interfaces between SP and I/O racks.
- Up to 16 SP PCBs - Quantity according to SP power requirement.
- PSUs - For cards as above.

## 6-6 I/O Racks

The I/O system for the OXF-R3 utilises a universal rack design for both analogue and digital I/O input and output modules.

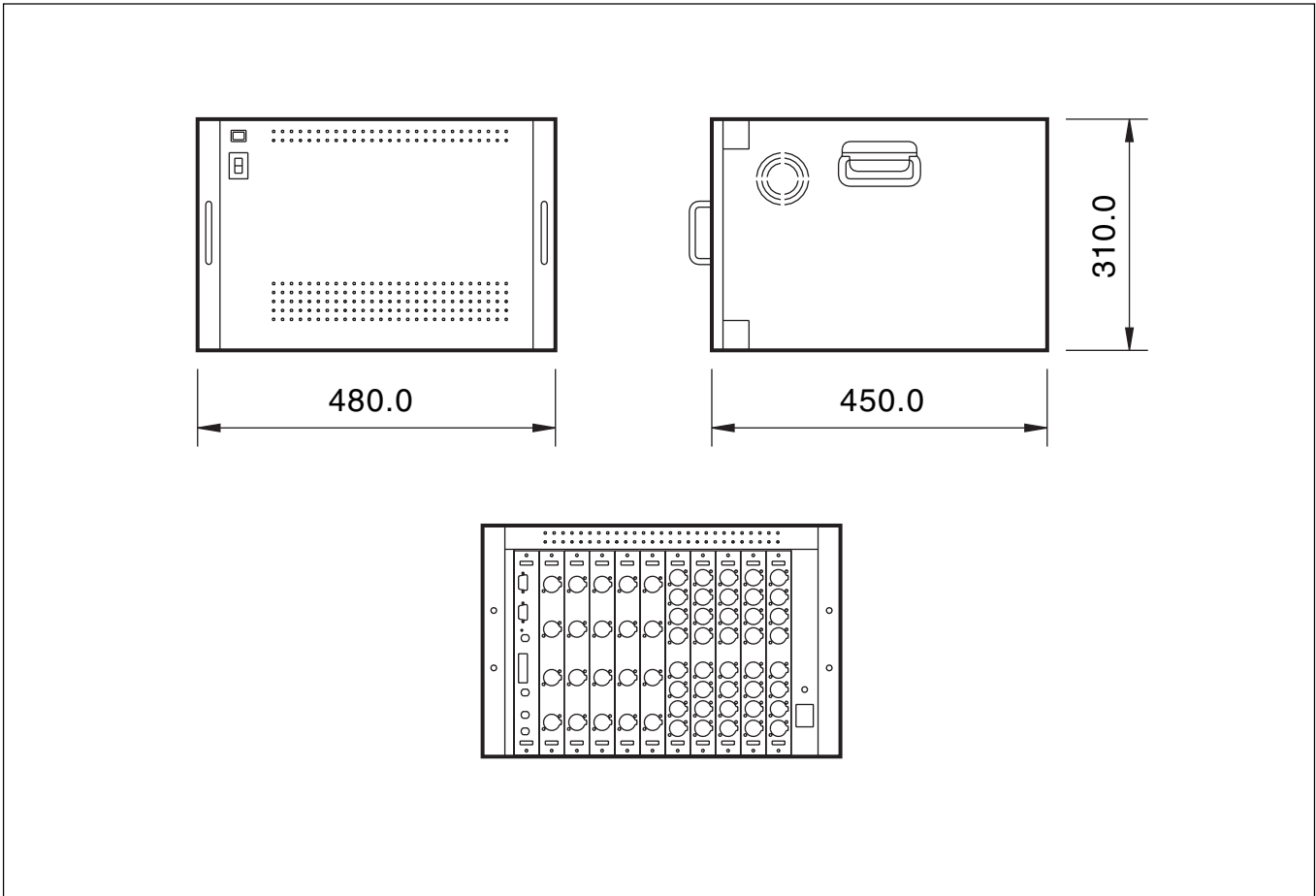

I/O Rack

### 6-6-1 I/O Rack Modules

Each I/O rack contains:

- 1 x Digital Link Card Module
- Up to 10 x Digital or Analogue I/O Modules





# Chapter 7 – Session Management™

## Chapter 7 Contents

<b>7-1 The Basics</b> .....	<b>7-2</b>
<b>7-2 Files Hierarchy and Automatable Controls</b> .....	<b>7-3</b>
7-2-1 Files Hierarchy .....	7-3
7-2-2 Automatable Controls .....	7-6
<b>7-3 File Data Storage</b> .....	<b>7-7</b>
<b>7-4 Programme Material</b> .....	<b>7-8</b>
<b>7-5 Mixing Overview</b> .....	<b>7-9</b>
7-5-1 Getting Started .....	7-9
7-5-2 Name the Artist/Project and Title .....	7-10
7-5-3 To Set Cue Points .....	7-11
7-5-4 To Automate Cuts .....	7-13
7-5-5 To Save a Mix .....	7-19
7-5-6 To Automate Fader Moves .....	7-20
7-5-7 Dropping Out of Write on Subsequent Mix Passes .....	7-21
7-5-8 To Record Absolute Moves for a Number of Faders .....	7-22
7-5-9 To Trim Fader Moves .....	7-22
7-5-10 To Trim Moves for a Number of Faders .....	7-22
7-5-11 To Automate a Pan Move (or any other Knob) .....	7-23
7-5-12 To Assemble a Mix .....	7-24
<b>7-6 The Session Management™ Screen Pages</b> .....	<b>7-27</b>
7-6-1 The Start-up Logo Screen .....	7-27
7-6-2 The System Screen .....	7-28
7-6-3 The Machines Screen .....	7-30
7-6-4 Artists/Projects & Titles Screen .....	7-32
7-6-5 Mixes & Cues Screen .....	7-35
7-6-6 Merge/Assemble Screen .....	7-40
7-6-7 Track Lists Screen .....	7-46
7-6-8 Snapshots, Copy & Link Screen .....	7-49
7-6-9 Copy Channel Fader Balance to M/T Faders and M/T to Channels .....	7-60
7-6-10 Copy Monitor and M/T Send Fader Balance to Cues .....	7-60
7-6-11 Quick Copy EQ A to B and B to A .....	7-60
7-6-12 Machine Remotes Screen .....	7-61
<b>7-7 Dynamic Automation Moves</b> .....	<b>7-64</b>
7-7-1 Motorised Fader Controls .....	7-64
7-7-2 Automating Faders .....	7-65
7-7-3 To Automate Cuts .....	7-70
7-7-4 To Automate Other Switches .....	7-76
7-7-5 To Automate a Pan Move (or any other knob) .....	7-77
7-7-6 Dropping Out of Write on Subsequent Mix Passes for Knobs .....	7-78
7-7-7 To Trim Pan Moves (or any other knob) .....	7-78
7-7-8 Automation Off and Selective Automation Isolate .....	7-79
7-7-9 Film Mode .....	7-80
7-7-10 Global Ready Enable .....	7-81
<b>7-8 Offline Automation</b> .....	<b>7-84</b>
<b>7-9 MIDI</b> .....	<b>7-89</b>
7-9-1 MIDI Control Pages .....	7-89
7-9-2 Setting MIDI parameters .....	7-90
7-9-3 MIDI Bars & Beats .....	7-93
<b>7-10 Backups</b> .....	<b>7-95</b>
<b>7-11 Preferences</b> .....	<b>7-101</b>

Historically, console automation systems have been used to automate the faders and cut buttons, together with a small number of additional controls, in order to record complex manipulations in synchronisation with the programme material. This avoids the artistic result being limited by the engineer's dexterity, memory and number of arms! The OXF-R3 console extends this concept in that all usefully automated functions can be controlled by the automated Session Management™ System.

During a typical music mixing session, a number of tasks are being performed simultaneously. The overall balance of the individual contributions is adjusted, and many signal processing changes might be made (such as equalisation or compression) to achieve the desired 'sound' from a particular set of sources. These changes are static in nature - for example, the engineer may make a number of adjustments to an equaliser as the programme material is played, listening to the result. When satisfied, the operator will stop moving the equaliser controls, leaving them in the position which achieves this result. The only setting, or automation data, of interest is the final position. The audition moves are of no interest. In other words, the vast majority of control manipulations in a mixing session are of this static type.

At the same time as the balancing is being carried out, some controls are being manipulated which do require to be replayed - called 'dynamic automation moves'. An example would be the use of a cut button to remove unwanted background noises on a particular track or to cut certain passages at specific times. The track may be 'cut' at appropriate times and, from then on, the same operation should occur every time the same programme material is replayed.

From the above, it can be seen that it is essential to have very flexible control over the automation system on an individual control basis. To simply 'record every move and control action' is the wrong approach. More time would be spent subsequently sorting out what was to be kept, compared to creating the mix in the first place. During a single play of a music track, many tens of balancing moves may be made, with perhaps dynamic moves (to be recorded) on just a few controls other than faders.

This assessment of the engineer's requirements leads to the following system requirements for music mixing:

1. By default, the system assumes that automation of the static or balancing type is required. As controls are moved, the most recent values are stored, and are applied throughout the duration of the programme.
2. Controls may be set on an individual basis to be dynamically automated as required. In this case the actual moves, relative to programme time, are recorded and played back on subsequent replays.

# 7-2 Files Hierarchy and Automatable Controls

## 7-2-1 Files Hierarchy

### General Files Structure

The automation data (files) are arranged in a traditional hierarchical manner. The layers are ARTIST/PROJECTS, TITLES and MIXES. The level for MIXES may also contain CUES, TRACK LISTS, SNAPSHOTS and NOTES relating to the current TITLE (see the following file structure diagram).

**Note:**

*Refer also to the Screens Structure diagrams in Chapter 5 - Control Screens.*

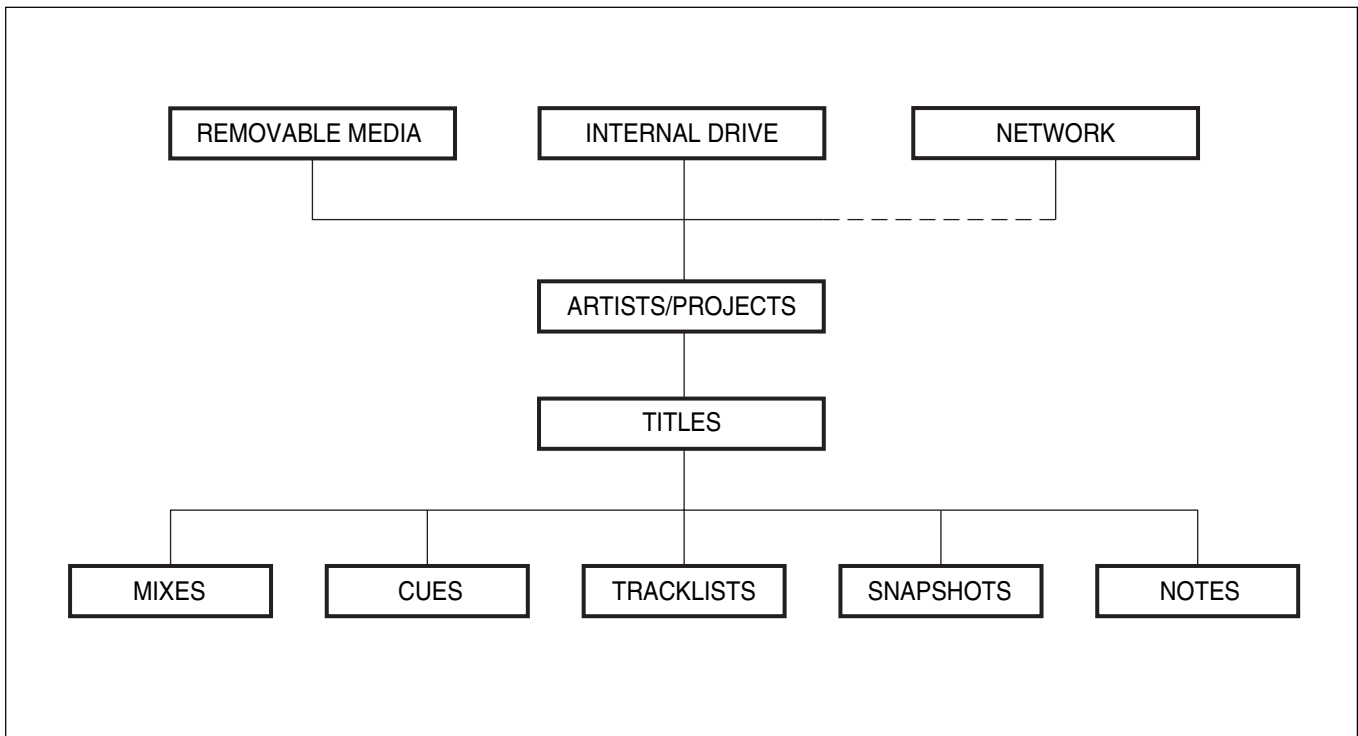

Files Structure

## 7-2 Files Hierarchy and Automatable Controls

### ARTISTS/PROJECTS

Are the headings for the jobs in progress e.g. session, album or show. Associated with the project will be further information such as details about the session, producer, engineer etc.

### TITLES

Represent specific sections of programme material - a track on an album for example, or a scene in a show. Creation of a new title implies defining a START and END time for the programme material e.g. against SMPTE timecode in the case of a present-day tape recorder. Once a TITLE has been defined, it can be used for control of the programme (e.g. PLAY TITLE ENTER) in addition to being the reference as regards data storage. START and END times can be re-defined at any time.

### MIXES

A MIX is a specific 'performance' of a title. Each mix contains all the data necessary to play the title, all its automated moves, and all static settings including the input and output set-ups and assignments. Many different MIXES may be created for a title, and the final MIX may well be created by combining sections from several earlier mixes.

### CUES

CUE points are specific listed time points within a title. They are numbered for quick reference and may be given names, which is normally more appropriate. CUE points may be added either explicitly by typing, or by actions 'on the fly'.

### TRACK LISTS

A TRACK LIST refers to the list of sound sources on a specific piece of storage e.g. the multitrack tape.

### NOTES

The list fields for entities such as Titles, Mixes and Cues have NOTES columns indicated by the note icon. Clicking on this column adjacent to the appropriate item causes a NOTES pop-up to appear.



NOTES icon

## SNAPSHOTS

A SNAPSHOT is a static set-up of all the console control settings and its input/output settings which may be stored and recalled at a later date. It is not time related and may be recalled at any time as a whole entity, or in part, as desired. Snapshots may be stored under various headings to which they relate: Titles, Factory, Studio and Users. Passwords may be used when storing SNAPSHOTS to protect them and to prevent unauthorised use. The Snapshot File Structure diagram is shown below.

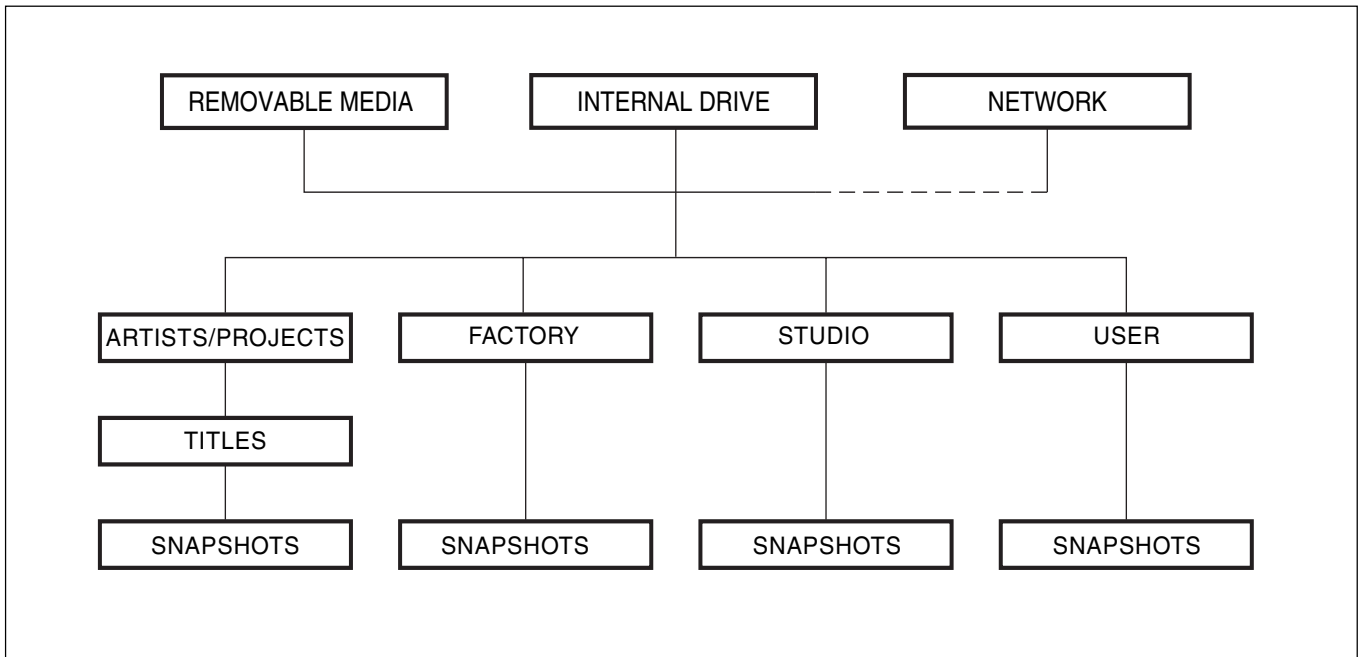

Snapshots File Structure

### Notes:

*Related NOTES may be compiled within all levels of the Session Management™ System on associated pages.*

### 7-2-2 Automatable Controls

#### Controls that can be automated

The following controls can be dynamically automated, but note that the static settings of all controls are stored alongside dynamic automation data.

- EQ
- Dynamics
- Delay
- MIDI Parameters
- Channel Faders, Control Group Faders and Main Output Fader
- Channel Cuts and Control Group Cuts
- Channel Pans and In/Out Buttons
- Multitrack Pans including Multi-Format Surround Pans
- Multitrack Send Levels and Cuts
- Send Levels, Send Cuts, Send Pans
- The 8 IN Buttons on the Input Channel & Inserts panel
- The A and B Equaliser buttons
- MIC, M/T and LINE Input Selector Push-buttons
- Knobs and Switches Assigned to MIDI Outputs

**Note:**

*The 8 IN buttons allow all channel processes such as EQ, Dynamics and Insert to be switched in and out of the channel path.*

# 7-3 File Data Storage

## General

Data for any files created is normally stored on the system hard drive, and may be transferred between systems using M.O. discs via the drive at the Host Computer. Systems in the same installation can have data transfer via network connections. This is set up using the PREFERENCES GUI, described later in Chapter 7.

## Compatibility between variants of the same S/W release level

Automation data is compatible between variants at the same revision level according to the Automation Compatibility Table below.

Automation Source Data	To DMSK-R3096 - 96Ch	To DMSK-R3072 - 96Ch
<b>DMSK-R3096 - 96Ch</b>		
<ul style="list-style-type: none"> <li>• Mono Channels 1-72</li> <li>• Mono Channels 73-96</li> <li>• Mono Returns 97-120</li> </ul>	<ul style="list-style-type: none"> <li>• Compatible</li> <li>• Compatible</li> <li>• Compatible</li> </ul>	<ul style="list-style-type: none"> <li>• Compatible</li> <li>• Compatible</li> <li>• No Destination Channels</li> </ul>
<b>DMSK-R3072 - 96Ch</b>		
<ul style="list-style-type: none"> <li>• Mono Channels 1-72</li> <li>• Mono Channels 73-96</li> </ul>	<ul style="list-style-type: none"> <li>• Compatible</li> <li>• Compatible</li> <li>• Mono Returns 96-120 are Reset to Defaults</li> </ul>	<ul style="list-style-type: none"> <li>• Compatible</li> <li>• Compatible</li> </ul>

OXF-R3 Automation Data Compatibility Table 1

## Automation data created using earlier S/W versions

There are major differences in the V3.0 system structure compared to V2.1 and earlier. The OXF-R3 now has an '8 wide' (7.1) Main Output Bus whereas it was previously stereo. There are a great many other changes too. However, many controls will match exactly and will be compatible. Where, for example, new control objects exist in V3.0, the system will be set to the boot-up default.

Where, within automation data from earlier versions, a multi-channel mix exists using the multitrack stem facility, the 'MAIN WIDTH' will be set to match the stem width. This is because the Main Output Bus is now the monitor path for stem mixes. The monitor path used to be via SSGs.

## V3.0 Automation Data and systems using earlier S/W

Loading automation data created on a system using V3.0 into a system using an earlier version such as V2.1, is not defined and therefore cannot be supported.

## 7-4 Programme Material

As described previously, creating a title will require the user to enter start and end points as times. It is assumed that the programme material is available on a machine (tape recorder, hard disc etc.) which is connected in such a way as to be able to locate to cue points, and to execute normal functions such as play or roll-back under the control of the automation system. It is also assumed that the machine will inform the automation system of its current position (e.g. by timecode) while it is playing. The machine may, in fact, be multiple tape recorders locked by synchronisers, or a single hard disc machine. This makes no difference to the operation of the console automation system.



# 7-5 Mixing Overview

## 7-5-1 Getting Started

The Session Manager Screens illustrated in this section are displayed on the LCD Control Screen in the centre section of the OXF-R3 console. The Mixing Overview is intended as an abbreviated guide to enable an experienced operator to start mixing as quickly as possible. In-depth information is provided later in this chapter.

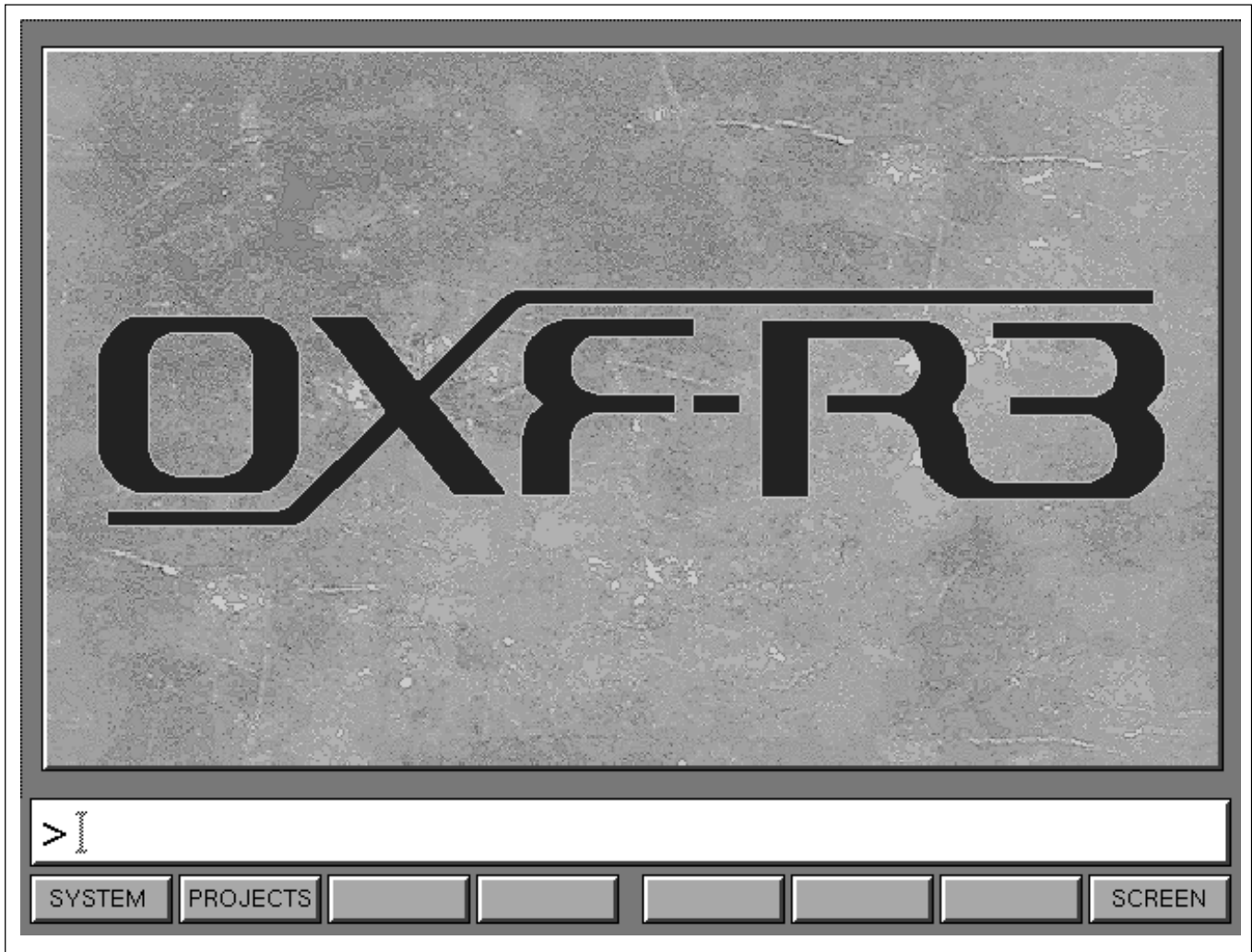

OXF-R3 Logo screen

The OXF-R3 logo screen is displayed after boot-up; the softkey functions at the base of the SMS allow selection of either SYSTEM (selecting pages for machine set-ups etc.), PROJECTS (to go to the Artists/Projects & Titles Screen) or SCREEN, which accesses a pop-up menu box showing all available screen selections.

Select PROJECTS by pressing the associated softkey.

**IMPORTANT:**

Before mixing is started, make sure the TIMECODE FORMAT and the SAMPLE RATE, for the current programme material, are set correctly in the System screen page.

**Note**

*Instructions requiring an object in a screen to be highlighted are referring to the orange highlight block.*

## 7-5-2 Name the Artist/Project and Title

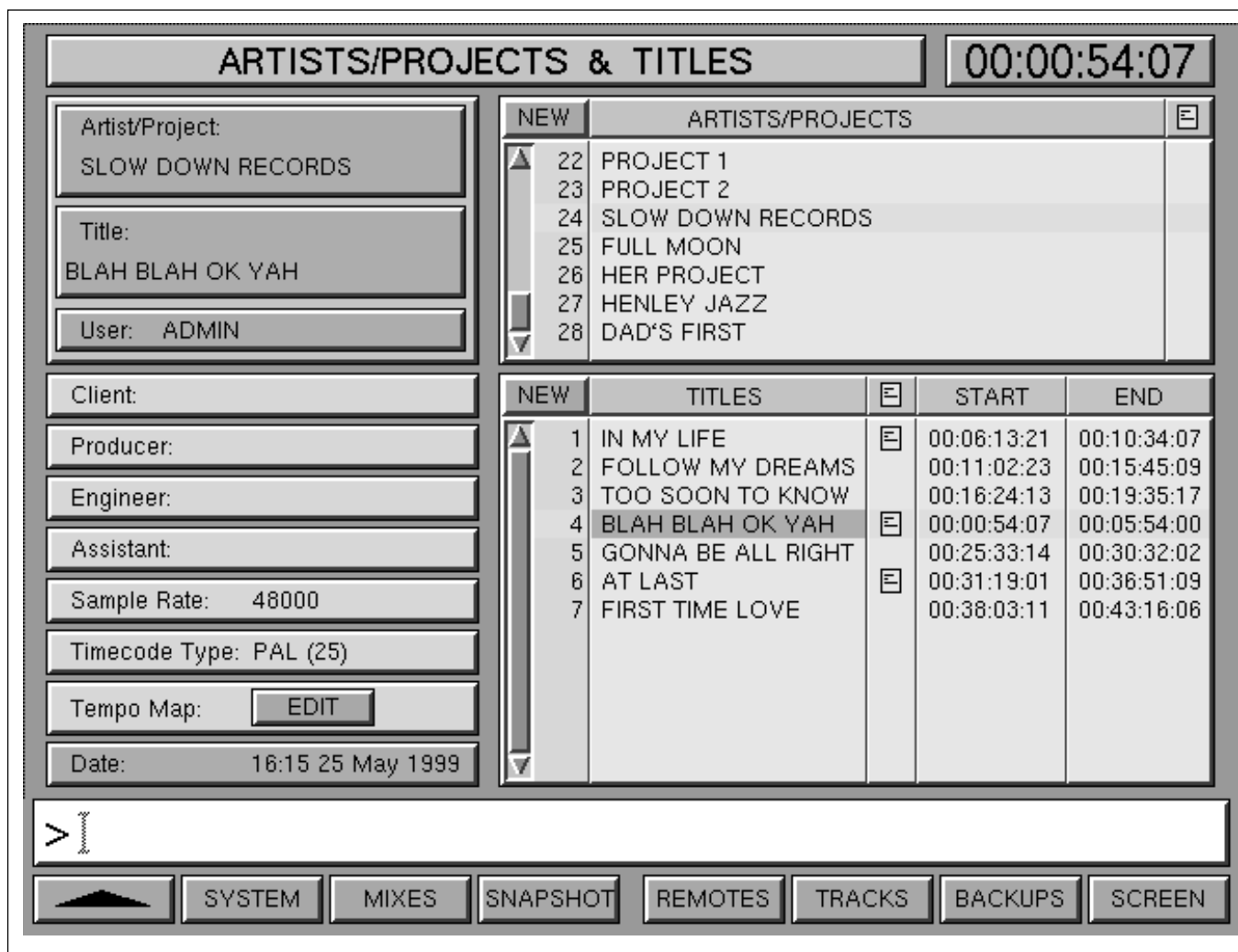

Artists/Projects & Titles screen

### To name ARTISTS/PROJECTS and TITLES

- 1 On the Control Keyboard, press **PROJECT** **ENTER** for a large pop-up to type in a name. Use the QWERTY keyboard to type in a suitable name, then either click on OK on the screen or press **ENTER** on the keyboard. Selecting OK or **ENTER** without a name will automatically enter a default name, Project 1 (or the next available). After a Project is named a Title pop-up will appear automatically.
- 2 To name subsequent Titles, press **TITLE** **ENTER** on the Control Keyboard. A large pop-up will appear, prompting the user to type in a name. Use the QWERTY keyboard to type in a suitable name then select OK on the screen or **ENTER**.
- 3 All dynamic data such as fader moves and cuts have to be time-related, so it is necessary to set start and end times for each Title. Move the orange cursor to the START column, alongside the new TITLE just named.
- 4 Click on the START column or press **EDIT** on the Control Keyboard to display a pop-up to type in the start time. Alternatively, enter time 'on the fly' by pressing **NOW** on the Control Keyboard at the appropriate instant whilst the tape is rolling. Roll back and repeat if incorrect.
- 5 Repeat steps 3 and 4 in the END column for the end time.

## 7-5-3 To Set Cue Points

Select the MIXES & CUES screen by pressing the MIXES softkey beneath the screen. The Start and End times set for the current Title will be displayed either side of the central timecode display.

The screenshot shows the MIXES & CUES screen with the following information:

- MIXES & CUES** (Title)
- RAMP TIME: 1000 ms
- PRE-ROLL: 3 sec
- TITLE: BLAH BLAH OK YAH
- MIX: (empty)
- START TIME: GUITAR PICS: 00:01:04:02
- END TIME: PRE SOLO BREAK: 00:03:46:23
- Central Timecode: 00:02:17:00
- STATUS:  PARKED

MIXES	13:54 27 May 1999	NEW	CUES	TIME
1	RHYTHM INTRO	1	START OF TITLE	00:00:54:21
2	GUITAR INTRO	2	GUITAR PICS	00:01:04:02
3	KIT INTRO	3	GUITAR INTRO	00:01:09:13
4	VOX HARMONY INTRO	4	KIT INTRO	00:01:13:02
5	LEAD VOX INTRO	5	VOX INTRO	00:01:23:02
6	RHYTHM INTRO + STRINGS	6	VERSE 1	00:01:31:08
7	KEYS UP TO KEY CHANGE	7	CHORUS 1	00:02:03:15
8	LEAD VOX	8	VERSE 2	00:02:26:22
9	RHYTHM	9	CHORUS 2	00:02:58:03
10	SAX SOLO	10	MIDDLE 8	00:03:21:07
11	BACK VOX	11	PRE SOLO BREAK	00:03:46:23
12	LEAD VOX FINE TUNE	12	SAX SOLO - VERSE	00:03:51:24
13	RHYTHM FINE TUNE	13	KEY CHANGE	00:04:23:01

>I

SYSTEM PROJECTS SNAPSHOT ASSEMBLE TRACKS OFFLINE SCREEN

Mixes & Cues screen

### To set cue points 'on the fly':

- 1 Roll the tape and press **[CUE]** on the Control Keyboard in readiness for setting a cue point. At the appropriate time, press **[ENTER]**. A pop-up will appear, prompting the user to type in a suitable name then either select OK on the screen or press **[ENTER]** on the keyboard.

Alternatively, press **[ENTER]** again for the default name of CUE 1, and a new cue point to be added to the list displayed on the right half of the screen.

- 2 Repeat as necessary for CUE 2, CUE 3, etc. To give useful names to these cues later, move the highlight to each Cue in turn and click on or press **[EDIT]** on the Control Keyboard for a dialogue box. Type in the name(s) required using the QWERTY keyboard.

## 7-5 Mixing Overview

### To set a cue point offline

- 1 Move the orange highlight to the desired line in the TIME column on the screen.
- 2 Click or press **EDIT** on the Control Keyboard. Type in the timecode and click **OK** or press **ENTER** on the Control Keyboard.

### To adjust the time of a cue point offline

- 1 Move the orange highlight to the TIME column on the screen and nudge the time with the **+** and **-** keys, or:
- 2 Click on the time entry or press **EDIT** on the Control Keyboard to display the timecode dialogue box. Type in the timecode and click **OK** or press **ENTER** on the Control Keyboard.

### Using the Numeric Key-pad to Enter Timecode

The entry format is exactly the same as that used for PCM-3324/48 series remote control units:

1	=	00:00:01:- -
12	=	00:00:12:- -
1234	=	00:12:34:- -
12345	=	01:23:45:- -
123456	=	12:34:56:- -
12345621	=	12:34:56:21
12:34:56:21	=	12:34:56:21
12:34:56	=	12:34:56:- -

### Timecode shortforms:

:: Separates hours/minutes  
: Separates minutes/seconds  
. Separates seconds/frame

12:: = 12:00:00:00 Specifies hours  
34: = 00:34:00:00 Specifies minutes  
56 = 00:00:56:00 Specifies seconds  
.21 = 00:00:00:21 Specifies frames

### To obtain a rough balance

- 1 On the Control Keyboard, press:  
**CYCLE** **TITLE** **ENTER**  
The source material will be repeated over and over again between the Start and End times allowing a fader balance to be created.

Alternatively, press:

**CYCLE** **CUE** # **CUE** # **ENTER**  
to use cue numbers for the selection.

- 2 Stop the tape when required using the Machine Remote transport **stop** key or press **CANCEL** on the Control Keyboard.
- 3 To repeat the operation, press:  
**REPEAT** **ENTER** on the Control Keyboard.

## 7-5-4 To Automate Cuts

Cuts may be set up for automation in two ways: using the local **ABS** (absolute) and **TRM** (trim) buttons above the faders, or using the master keys **READY ABSOLUTE** and **READY TRIM** buttons beneath the central LCD screen. The method for local buttons will be described first.

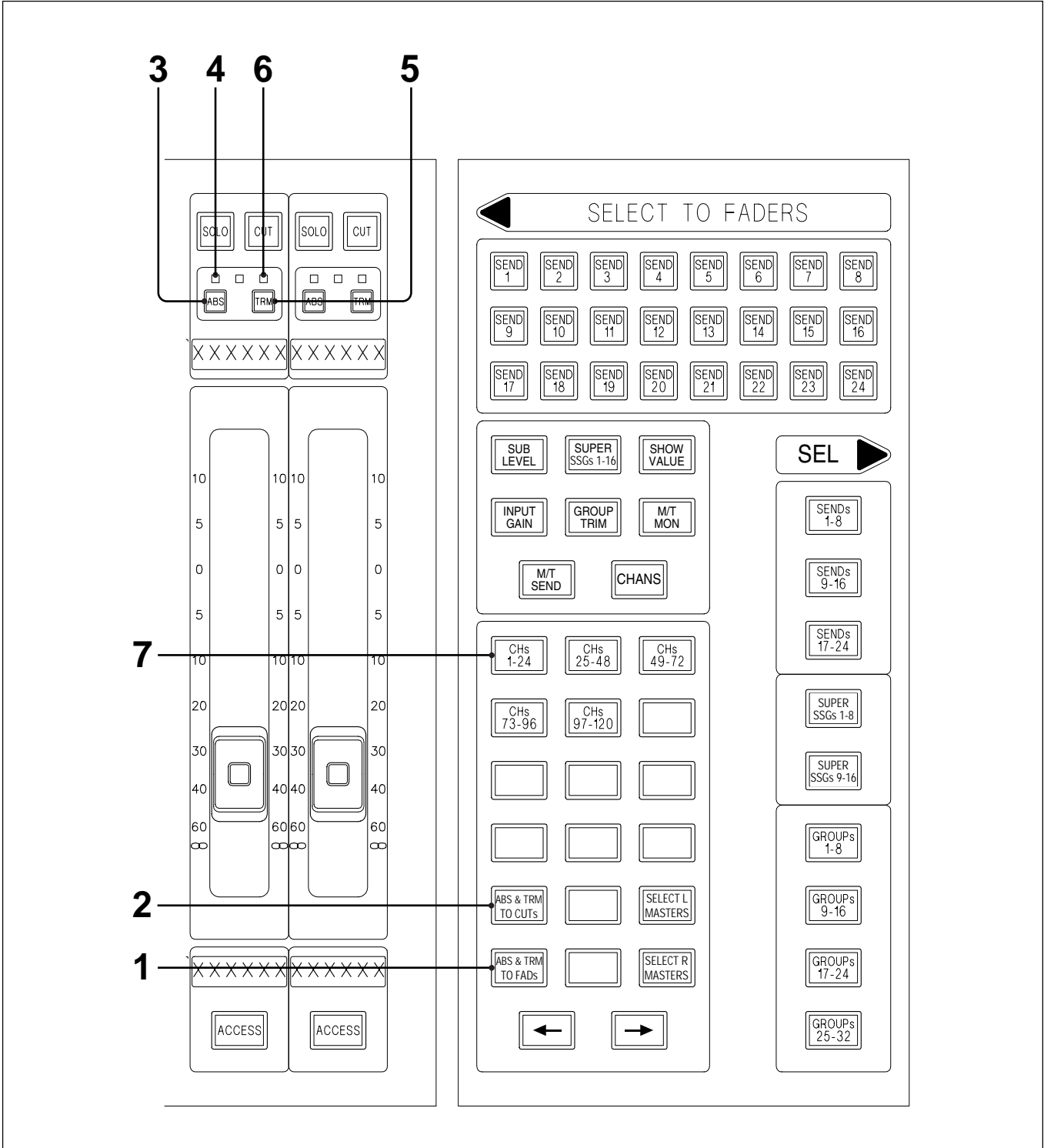

Setting automation of Cuts locally

## 7-5 Mixing Overview

### To set up Cuts for automation locally

See the diagram - 'Setting automation of Cuts locally'.

- 1 The **ABS** and **TRM** buttons above the faders are assigned to the faders by default. **ABS + TRM TO FADs** will be lit to indicate this.
- 2 Press **ABS + TRM TO CUTs** to assign the **ABS** and **TRM** buttons to the cuts.
- 3 Press **ABS** for the cuts to be automated where new data is to be written. This will overwrite previous data.
- 4 Their red LEDs flash to indicate their 'ready' status.
- 5 Press **TRM** for cuts to be automated where cut data is to be modified or added to.
- 6 Their green LEDs will flash to indicate their 'ready' status.
- 7 To set a bank of 24 cuts into 'ready' status, press and hold **CHS 1-24**, for example, until it turns amber and then press any **ABS** or **TRM**.

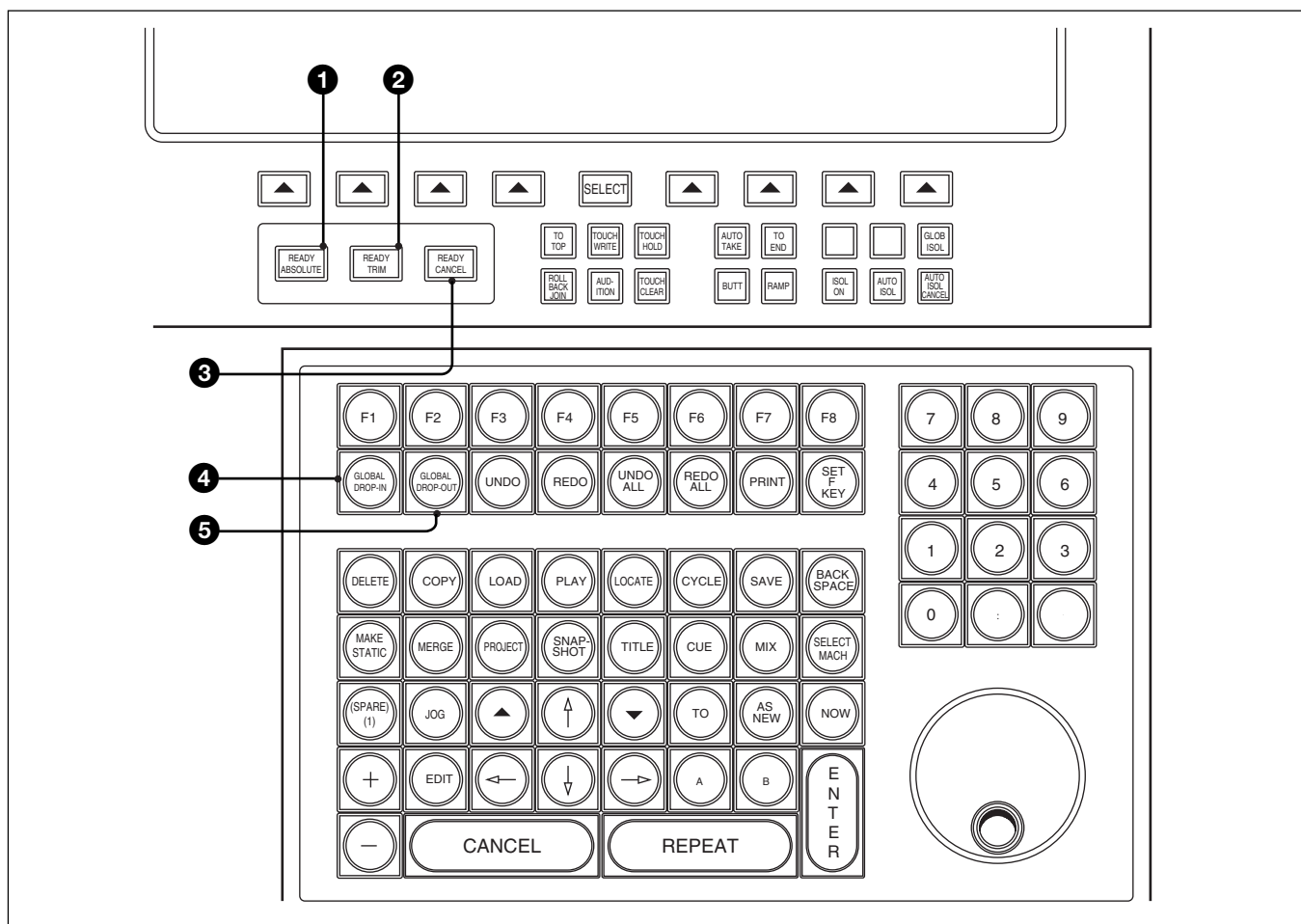

Automation master keys

### To set up Cuts for automation using the central master keys

#### 1 READY ABSOLUTE Push-Button

This latching button allows the user to set cuts into an 'automation ready' state where new cuts can be written which will overwrite previous data. If any cuts were already lit, their lights will go out for the set-up during the period that **READY ABSOLUTE** is latched.

Latch **READY ABSOLUTE** and press any cuts to be automated and they will flash to show that they are enabled. When **READY ABSOLUTE** is pressed again, de-selecting it, the enabled cuts return to their previous states. Rolling the tape causes **READY ABSOLUTE** to be de-selected automatically.

## 2 READY TRIM Push-Button

**READY TRIM** works in the same way as **READY ABSOLUTE**. It allows cuts to be set up such that existing cuts can be modified, or additional cuts created, without overwriting previous cuts.

## 3 READY CANCEL Push-Button

**READY CANCEL** takes all controls out of the 'ready' state and returns them to a 'safe' mode.

## 4 GLOBAL DROP-IN Key

**GLOBAL DROP-IN** puts the cuts which are set up 'ready' into write and can be actioned either before the tape is rolling or while it is rolling. Once **GLOBAL DROP-IN** is selected, the cuts can be actioned, whilst the tape is rolling. To revise any cuts, roll the tape back and play again. The cuts will be replayed and none will be overwritten until **GLOBAL DROP-IN** is pressed once more.

Alternatively, an individual switch will drop into automation record at the moment it is pressed, changing its state at the same time.

### Note:

The state of a switch can be retained when dropping in using **READY ABSOLUTE** by holding its **ABS** button whilst pressing the switch.

## 5 GLOBAL DROP-OUT Key

**GLOBAL DROP-OUT** causes all controls to drop out of automation record.

### To automate cuts

- 1 To start at the beginning of the Title, on the Control Keyboard press:
  - LOCATE** **TITLE** **ENTER**
  - or:
  - LOCATE** **ENTER**
 to locate to the last entered starting time.
- 2 'Ready' enable the cuts to be automated with **READY ABSOLUTE** (or **READY TRIM**) or: 'Ready' enable cuts using the 'local' method described at the beginning of this section.
- 3 Press **GLOBAL DROP-IN** either before or after rolling the tape to drop all 'ready' enabled cuts into automation record, or press switches individually.

- 4 Write cuts as required.

### Note:

To audition a channel which is cut, assign the Definable Knobs to **INPUT GAIN** and press **AFL** on the appropriate channel.

- 5 Press **GLOBAL DROP-OUT** after writing cuts.

- 6 Press **READY CANCEL** and then **PLAY** **ENTER** on the Control Keyboard to hear the result and note that automated cuts are indicated by switches lighting amber.

### Note:

As soon as any automation has been recorded, the message '(New) 1 DYNAMIC LAYER' is displayed on the **MIXES & CUES GUI** at the top right, to indicate that un-saved automation data is resident in the system.

## UNDO and REDO functions

As passes are made by rolling forwards and back, a set of un-saved passes is built up which is resident in the system memory. Use **UNDO** to step backwards through individual passes to the last **SAVE** command and **REDO** to go forwards. Press **UNDO ALL** to go all the way back in one step and **REDO ALL** to go all the way forwards in one step.

### Individual channel UNDO

To undo automation actions for an individual channel, press and hold **ACCESS** for that channel, then press **UNDO**. All automation data for the last pass will be removed from any controls that were automated. Repeat for other individual channels.

### Note:

*UNDO operations for individual channels cannot be reversed using REDO.*

### How to modify cuts using READY TRIM

### Note:

*Although it is often easier to rewrite cuts rather than modify them, the following online functions are available. (Offline adjustments can be made using the **OFFLINE: CUTS GUI**).*

- 1 'Ready' Trim enable the cuts to be automated with the central **READY TRIM** button or: 'Ready' Trim enable the cuts using the 'local' method described at the beginning of this section.

## 7-5 Mixing Overview

- 2 Press **GLOBAL DROP-IN** either before or after rolling the tape to drop all 'ready' enabled cuts into automation record, or press switches individually.
- 3 Press **GLOBAL DROP-OUT** after writing cuts and then **READY CANCEL** followed by **PLAY** **ENTER** to hear the result.

**Note:**

The bi-colour LEDs in the cut switches help with the operation of these functions. The red light indicates manual actions and amber those being performed by the computer. Extra bright red/amber indicates simultaneous manual and computer control.

### To add a new cut:

Adding a new cut in between previous cuts, with no overlap, is straightforward. Implement as previously described.

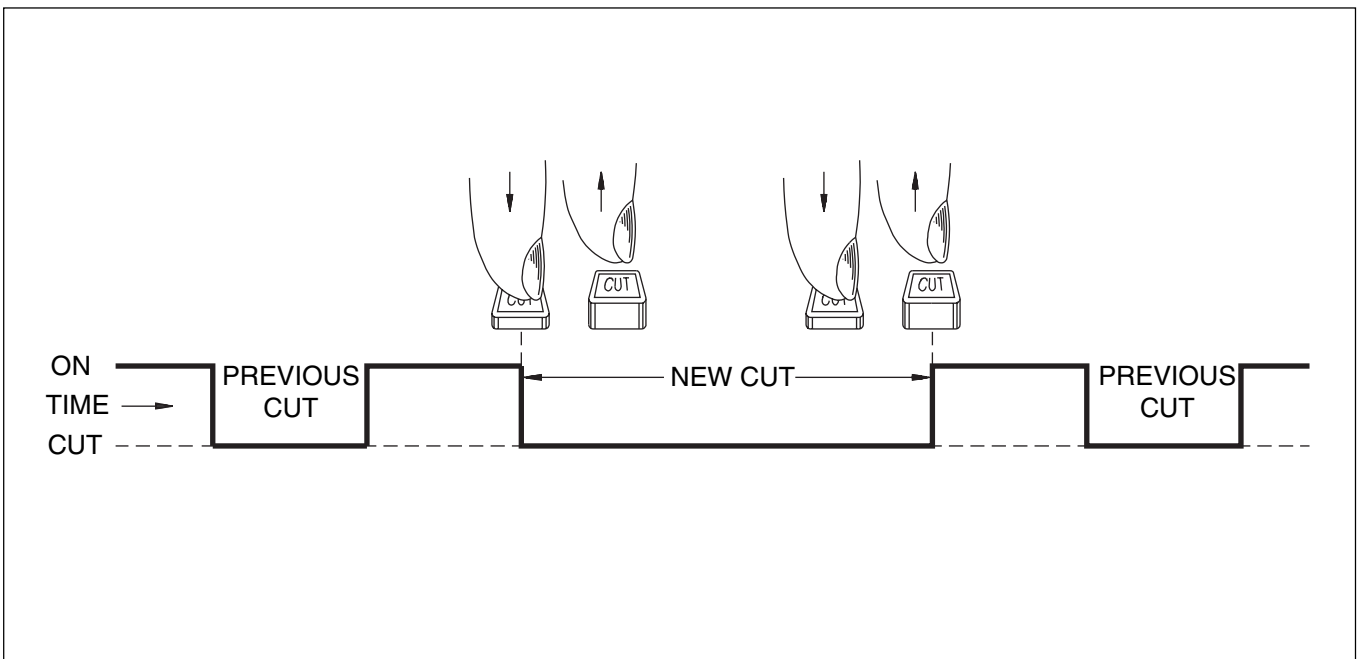



**Advance the in-point:**

Push the CUT switch earlier and hold until the original in-point is passed, then release.

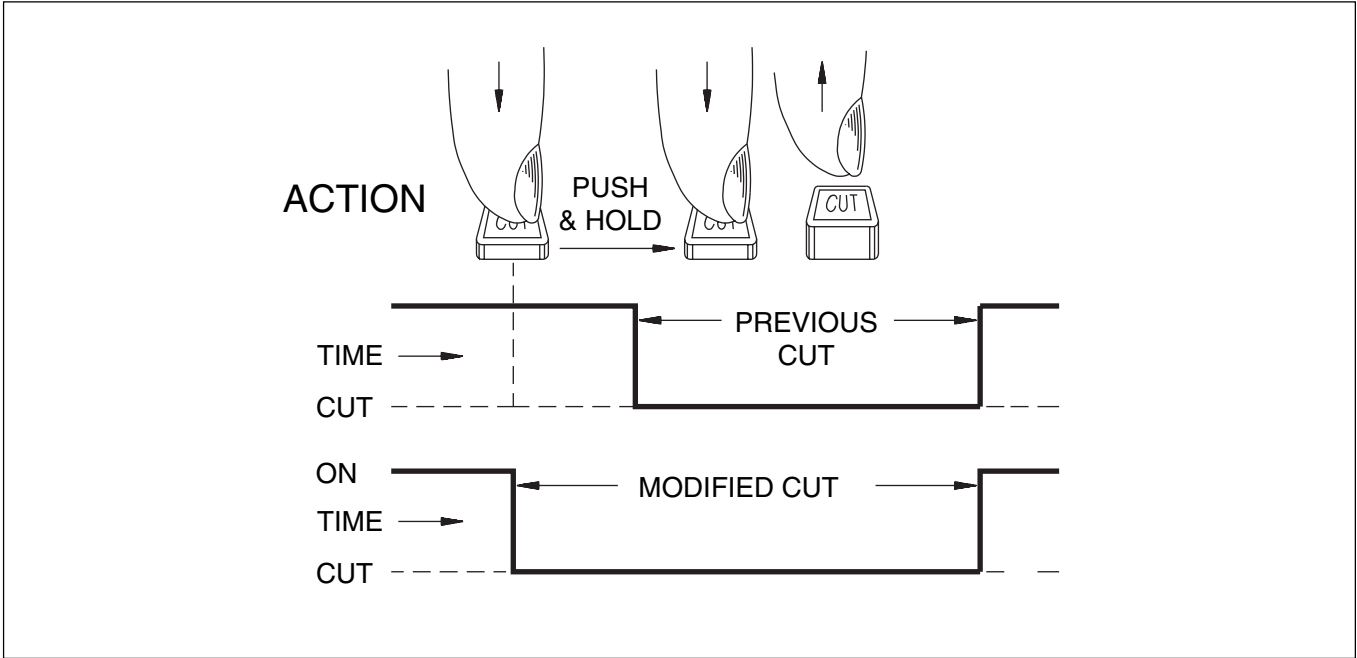

**Advance the out-point:**

Push the CUT switch and hold during the original cut, then release at the new (earlier) out-point.

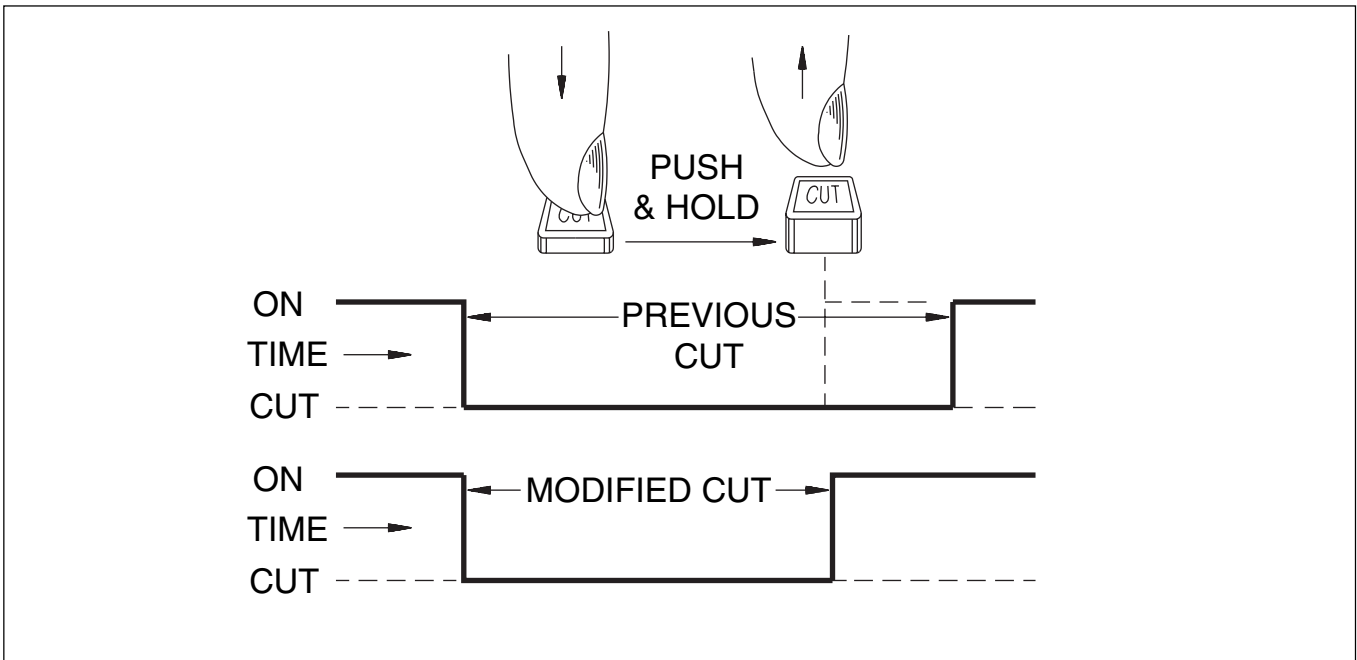

## 7-5 Mixing Overview

### To make a cut longer:

Push and hold the CUT switch during the original cut.  
Release at the new (later) out-point.

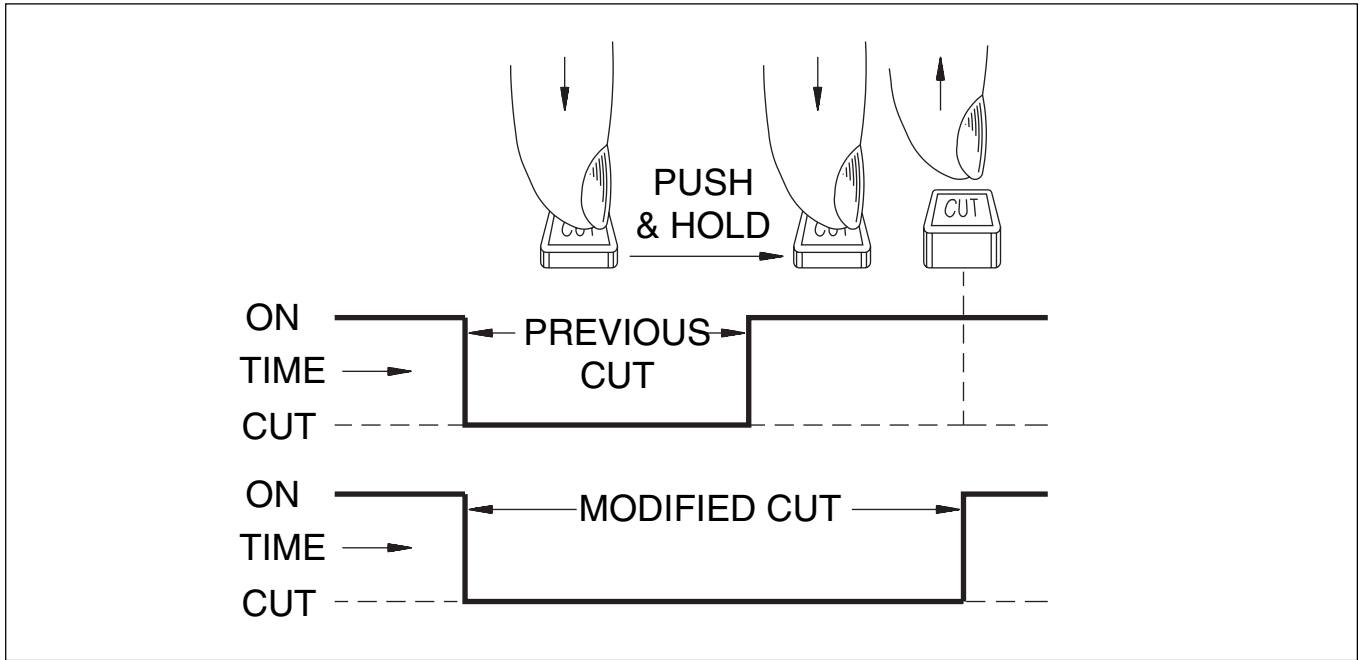

### To erase a cut completely:

Push and hold before the original in-point and release  
after the original out-point.

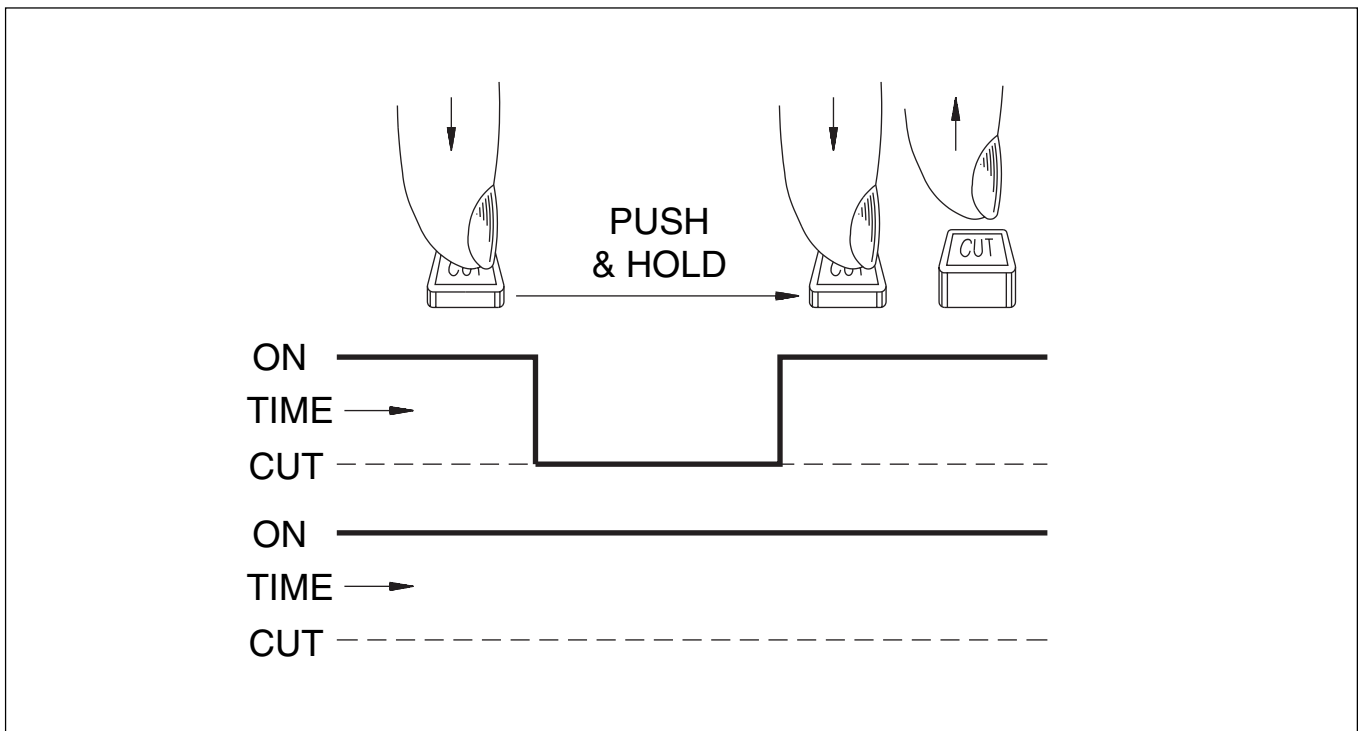

## 7-5-5 To Save a Mix

A mix, or part mix, can be saved at any time. So far, the automation data for any cuts has been resident in the 'working mix' and has not been saved to the internal hard drive.

The screenshot shows the 'MIXES & CUES' interface. At the top, it displays 'RAMP TIME: 9732 ms', 'PRE-ROLL: 0 sec', and '(New) 1 DYNAMIC LAYER'. Below this, the title is 'BLAH BLAH OK YAH' and the mix is 'MIX:'. A large central display shows the time '00:02:06:15'. To the left, 'START TIME: GUITAR PICS' is shown as '00:01:04:02'. To the right, 'END TIME: MIDDLE 8' is shown as '00:03:21:07'. The main area contains two lists: 'MIXES' and 'CUES'. The 'MIXES' list has one entry: '1 RHYTHM INTRO'. The 'CUES' list has 13 entries, with '7 CHORUS 1' highlighted. At the bottom, there is a 'PLAY MIX' button and a row of navigation buttons: SYSTEM, PROJECTS, SNAPSHOT, ASSEMBLE, TRACKS, OFFLINE, and SCREEN.

MIXES	14:59 03 Jun 1998	NEW	CUES	TIME
1	RHYTHM INTRO	1	START OF TITLE	00:00:54:21
		2	GUITAR PICS	00:01:04:02
		3	GUITAR INTRO	00:01:09:13
		4	KIT INTRO	00:01:13:02
		5	VOX INTRO	00:01:23:02
		6	VERSE 1	00:01:31:08
		7	CHORUS 1	00:02:03:15
		8	VERSE 2	00:02:26:22
		9	CHORUS 2	00:02:58:03
		10	MIDDLE 8	00:03:21:07
		11	PRE SOLO BREAK	00:03:46:23
		12	SAX SOLO - VERSE	00:03:51:24
		13	KEY CHANGE	00:04:23:01

Mixes & Cues screen

### To save a mix

To save a mix for the first time, press **SAVE** **MIX** **ENTER** on the Control Keyboard. A pop-up dialogue box will appear for a name entry. Type in an appropriate name on the QWERTY keyboard or press **ENTER** once more or click on **OK** for the default name, MIX 1. This will appear as the first entry in the MIXES list. To edit mix names later, either highlight and click on or press **EDIT** for the name dialogue pop-up.

If **SAVE** **MIX** **ENTER** is used again, the new mix will overwrite the previous one, in just the same way as SAVE works on a word processor.

Use **SAVE** **MIX** **AS NEW** **ENTER** to avoid overwriting the previous mix. A pop-up will appear for a new name entry, or press **ENTER** or click on **OK** for the next default name.

When a mix is saved, so is the static position of the complete console. If the mix is recalled at a later date, everything will be completely reset to its previous static position, apart from controls which were automated. Their settings and movements will be referenced to timecode.

## 7-5 Mixing Overview

### 7-5-6 To Automate Fader Moves

The procedure to automate fader moves is very similar to cuts. **[ABS + TRM TO FADERS]** must be selected on the SELECT TO FADERS panel to assign the **[ABS]** (absolute write) and **[TRM]** (trim) buttons to faders. Make sure **[BUTT]** is the only button selected under the central LCD.

To start at the beginning of a Title, move the highlight to the desired Title in the ARTISTS/PROJECTS & TITLES GUI and press **[LOCATE]** **[TITLE]** **[ENTER]** on the Control Keyboard. To add fader moves to a mix which may already have cuts written, highlight the mix and **[LOCATE]** **[MIX]** **[ENTER]**.

Press the **[ABS]** button above the fader and its red LED flashes indicating 'ready' status. To record fader moves from the very start, press the **WRITE** button in the fader knob and the LED goes on solid. Then roll the tape. To record moves some way into the Title, roll the tape before pressing **WRITE**. To stop moves being recorded, press **WRITE** again and the **[ABS]** LED flashes. If the moves are over just part of the Title, then the exact position at the drop-in point is assumed to the beginning. Exactly the same fader level will also be applied to the end of the Title from the automation drop-out point. From then on, the fader will snap back for the duration of the whole Title. To take the setting after the last move to the end of the Title, select **[TO END]** under the central LCD.

To revise any moves, just roll back and play again. The moves from the previous pass will be displayed until the **WRITE** button is pressed once more. The motorised fader will reflect previous moves unless the fader knob is touched. Even when it is touched, the previous moves will still be heard until **WRITE** is pressed, when the absolute fader positions and moves will be heard as well as recorded.

Press **[ABS]** again when recording moves for a fader is finished, to make it 'safe'. (It is also possible to press **[ABS]** to drop out whilst the tape is rolling).

To record moves with TOUCH WRITE, select **[TOUCH WRITE]** beneath the central LCD and then, if Ready **[ABS]** is selected, just touching the fader knob will write moves. In the event of a mistake, just roll back and try again. The **WRITE** button in the fader knob is still operational in TOUCH WRITE.

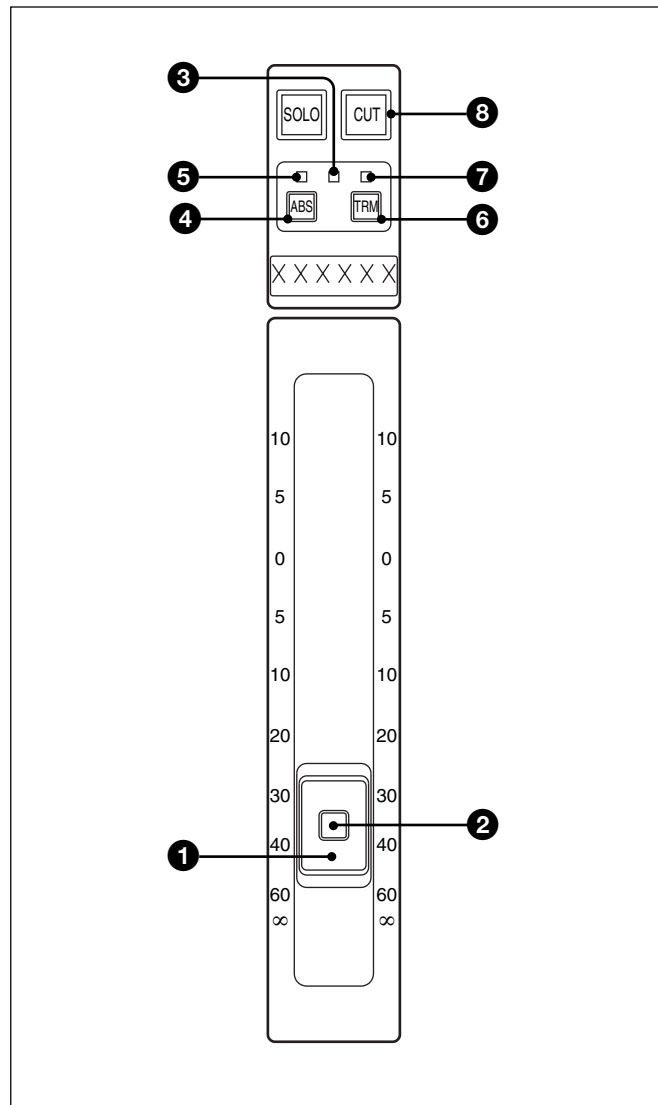

Fader controls

- 1 Touch-sensitive fader knob
- 2 Automation Write button
- 3 Yellow Touch LED
- 4 Ready ABS (Absolute) Write button
- 5 Red Absolute Write LED
- 6 Ready TRM (Trim) button
- 7 Green Trim Write LED
- 8 Bi-colour - Red/Amber Fader Cut switch

## 7-5-7 Dropping Out of Write on Subsequent Mix Passes

There are four ways to drop out of WRITE when dropping back to previous moves. The buttons for these four modes are on the mid right part of the panel at the base of the central LCD.

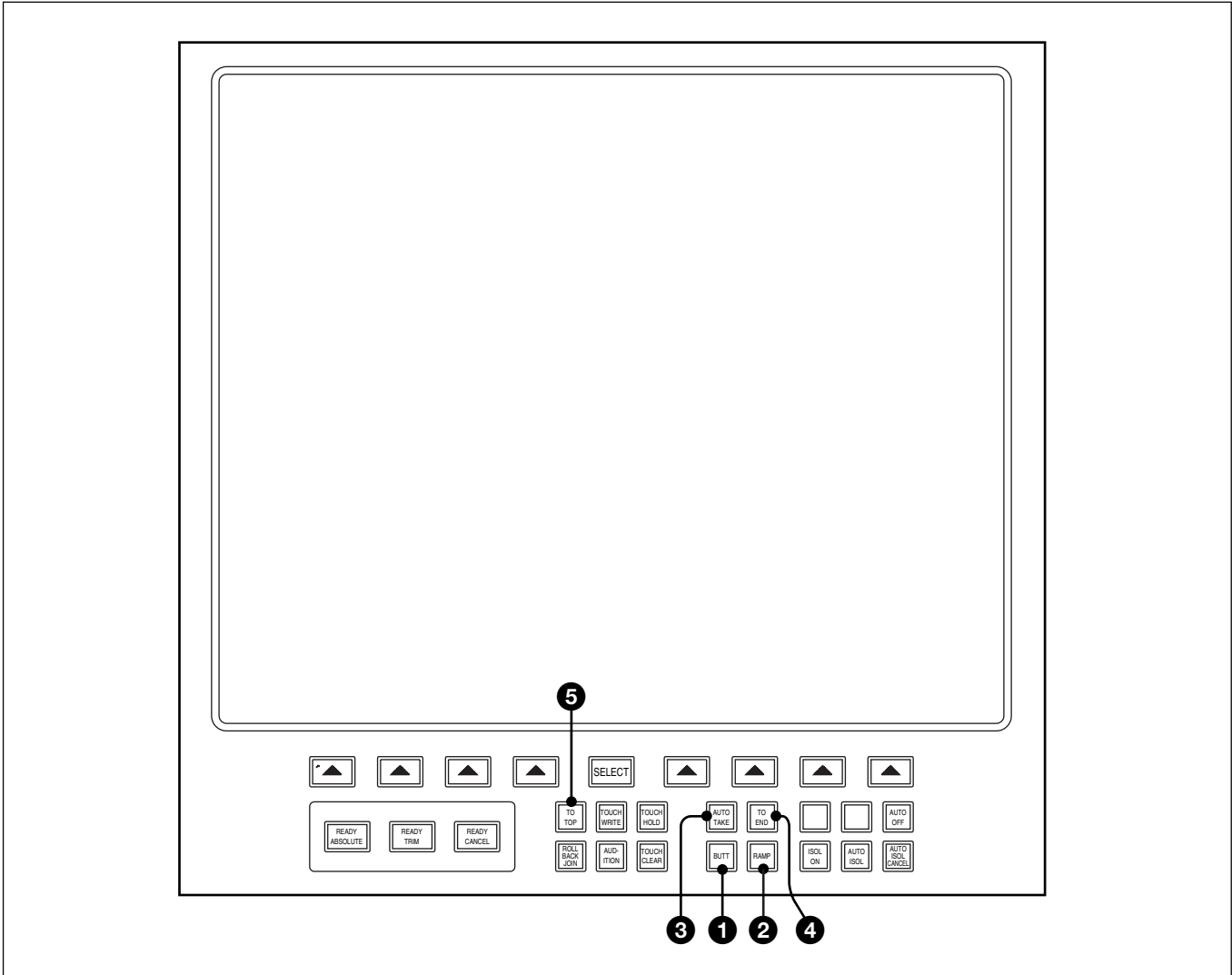

Central LCD Screen panel layout

- ❶ **BUTT** - (default) Where a jump occurs at the drop-out point.
- ❷ **RAMP** - Where a user defined time is taken to slew to the previous move. (Set the time in MIXES & CUES GUI).
- ❸ **AUTO-TAKE** - Where the operator manually fades to the previous move.
- ❹ **TO END** - Where the fader position at the drop-out point is recorded to the end of the Title for both absolute and trim functions.

These four buttons inter-cancel but it is possible to use different modes on different faders. This is achieved by working in one mode first and then rolling back to use another mode on other faders. Different modes can be used on the same fader at different times.

### ❺ **TO TOP Push-Button**

A related function allowing fader position to be recorded from any point within the Title to the beginning, for both absolute and trim. If a fader is in record then it is the point at which **TO TOP** is pressed which determines the level. If **TO TOP** is already on then it is the point the fader is dropped into record.

## 7-5 Mixing Overview

### 7-5-8 To Record Absolute Moves for a Number of Faders

This functions in exactly the same way as for one fader except that once the desired faders are in 'ready ABS' mode, they may be put into full WRITE individually using their local **WRITE** buttons, or simultaneously using the **GLOBAL DROP-IN** button on the Control Keyboard.

**GLOBAL DROP-OUT** takes all faders out of WRITE as with cuts.

This also applies to TOUCH WRITE where **WRITE** buttons in fader knobs have been used to latch automation record.

Use the **READY CANCEL** button below the central LCD to drop all controls completely out of automation record.

### 7-5-9 To Trim Fader Moves

Select **TRM** locally for the desired fader, and its green LED flashes. Press the **WRITE** button in the fader knob before starting the tape or while it is rolling and the LED goes on solid, indicating that moves will be recorded.

If the tape is rolling, previous moves will be heard and displayed on the fader before the knob is touched.

The moves will still be heard if the fader is touched and moved.

The previous moves will be heard whether or not **WRITE** has been pressed.

Before pressing **WRITE**, move the fader knob to a suitable part of the fader scale with good resolution. This will become the null point around which **TRIM** fader moves can be trimmed, at the moment **WRITE** is pressed. The '0' position is recommended as a good reference point for trimming moves.

Any trimmed moves will add or subtract from the null point according to the fader scale. Dropping out of **TRIM** functions in the same way as coming out of **ABS** mode.

Select **SHOW VALUE** at the SELECT TO FADERS panel to display fader gain settings in dBs on the electronic scribbles.

### 7-5-10 To Trim Moves for a Number of Faders

Put the desired Faders into ready trim locally by pressing the **TRM** buttons by the faders, and use either local **WRITEs** or **GLOBAL DROP-IN** and **GLOBAL DROP-OUT** to action the recording of moves.

The steps to save a mix are as previously described in Section 7-5-5.

## 7-5-11 To Automate a Pan Move (or any other Knob)

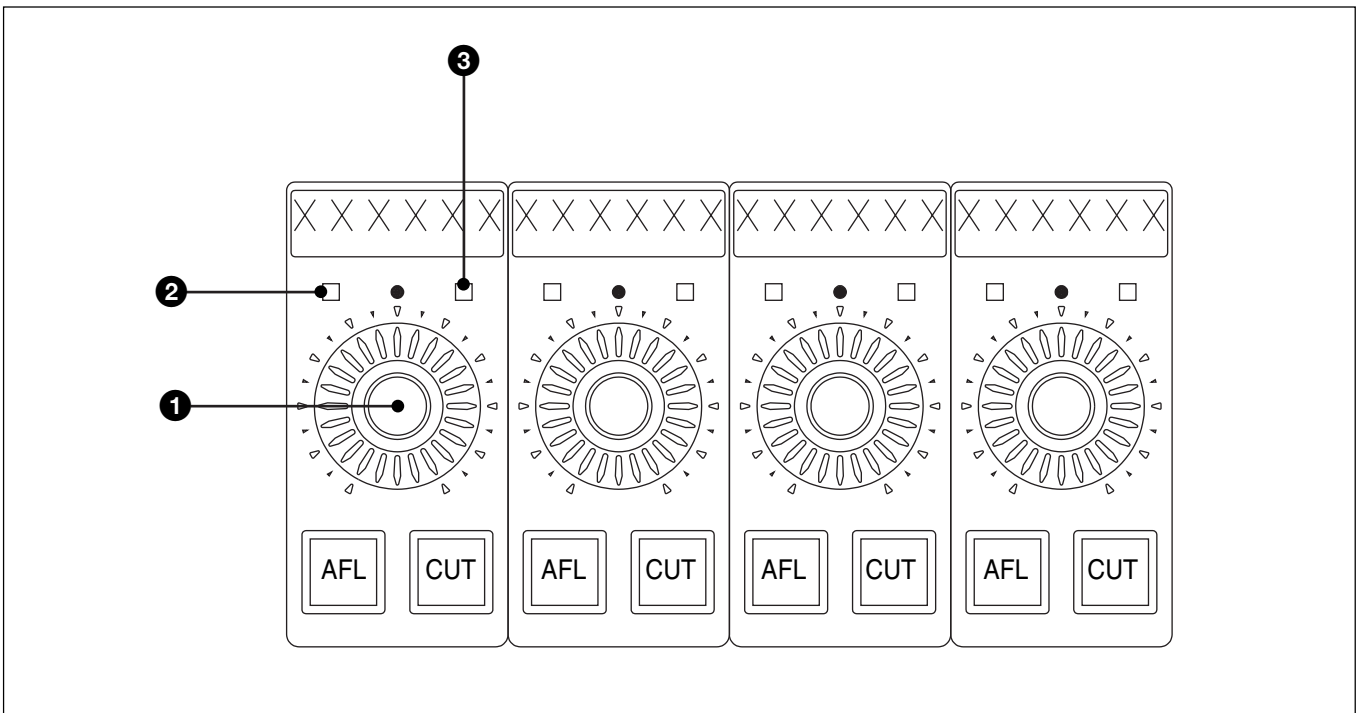

Assignable Pan knobs

- ❶ Pan knob (Press for Switch)
- ❷ Red Absolute LED
- ❸ Green Trim LED

To enable a PAN to have its moves recorded, first latch **READY ABSOLUTE** below the central LCD. Then press the **PAN** knob and its red LED flashes to show that the system is ready to record absolute moves. De-select **READY ABSOLUTE** or roll the tape, in which case it will be de-selected automatically.

Press the **PAN** knob again, either before or after the tape is rolling, and the LED will light solidly, indicating that moves will be recorded. Roll-back for the knobs works in the same way that it does for faders. The difference is that instead of the knobs moving, the LEDs in the skirts of the knobs reflect any automation moves.

When the moves are complete, press the **PAN** knob again and the red LED flashes indicating that the mode has reverted to ready absolute. Use **READY CANCEL** to take the **PAN** knob out of 'ready absolute' status.

To trim PAN moves, first latch **READY TRIM** below the central LCD, then press the **PAN** knob so that its green LED flashes. De-select **READY TRIM**, or allow it to be de-selected automatically when the tape starts rolling. Press the **PAN** knob either before or after rolling the tape. The green LED will light solidly, indicating that any trimming moves will be recorded.

Whilst the knob is in the ready state, the LEDs around the skirt of the knob will indicate previous moves. The position of the knob at the drop-in point i.e. when the knob is pressed, becomes the null point for any trimmed moves.

When the moves are complete, press the **PAN** knob to drop back to ready status, then press **READY CANCEL** to drop out completely.

## 7-5 Mixing Overview

### 7-5-12 To Assemble a Mix

The MERGE/ASSEMBLE GUI allows Mixes and Snapshots from any source to be merged with the current Working Mix. Each bar in the GUI represents a Mix Layer and these may include additional Dynamic Layers.

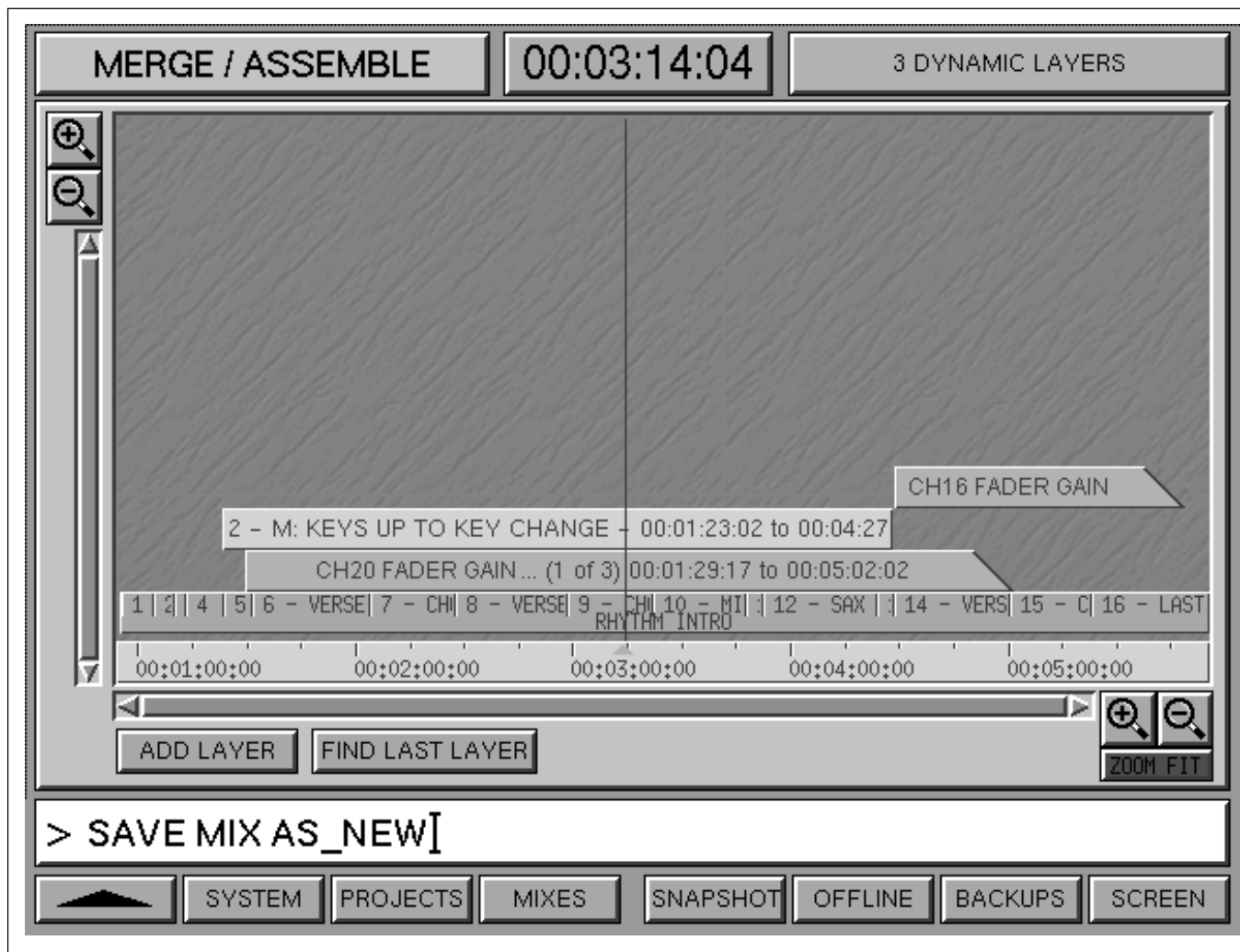

MERGE/ASSEMBLE screen

- 1** Select the ASSEMBLE softkey at the bottom of the central LCD and a time-line GUI will display the current Working Mix as a bar along the bottom of the screen. Individual bars for each unsaved Dynamic Layer will also be displayed. Any New Dynamic Layers will appear after creation, once the tape is put into rewind.
- 2** To add a new layer from a previous Mix or Snapshot click on ADD LAYER to view the pop-up on the next page. Extensive options are available but a simple case will be described in this overview which involves copying mix data within a Title from Verse 1 to Verse 2.
- 3** Select the source data using the upper section of the GUI. The default source is the current Artist/Project, Title and its Working Mix. The mix data for Verse 1 is already resident in the Working Mix so this is the correct source mix for this example. Any other source can be selected by clicking on the appropriate ▼ to the right of its name strip for a pop-up list.
- 4** Having established the correct source, set a start time for the source data in the SOURCE 'FM' section which may be a Cue point or timecode entry. 'VERSE 1' is displayed in the example. Click on ▼ to the right of the name strip



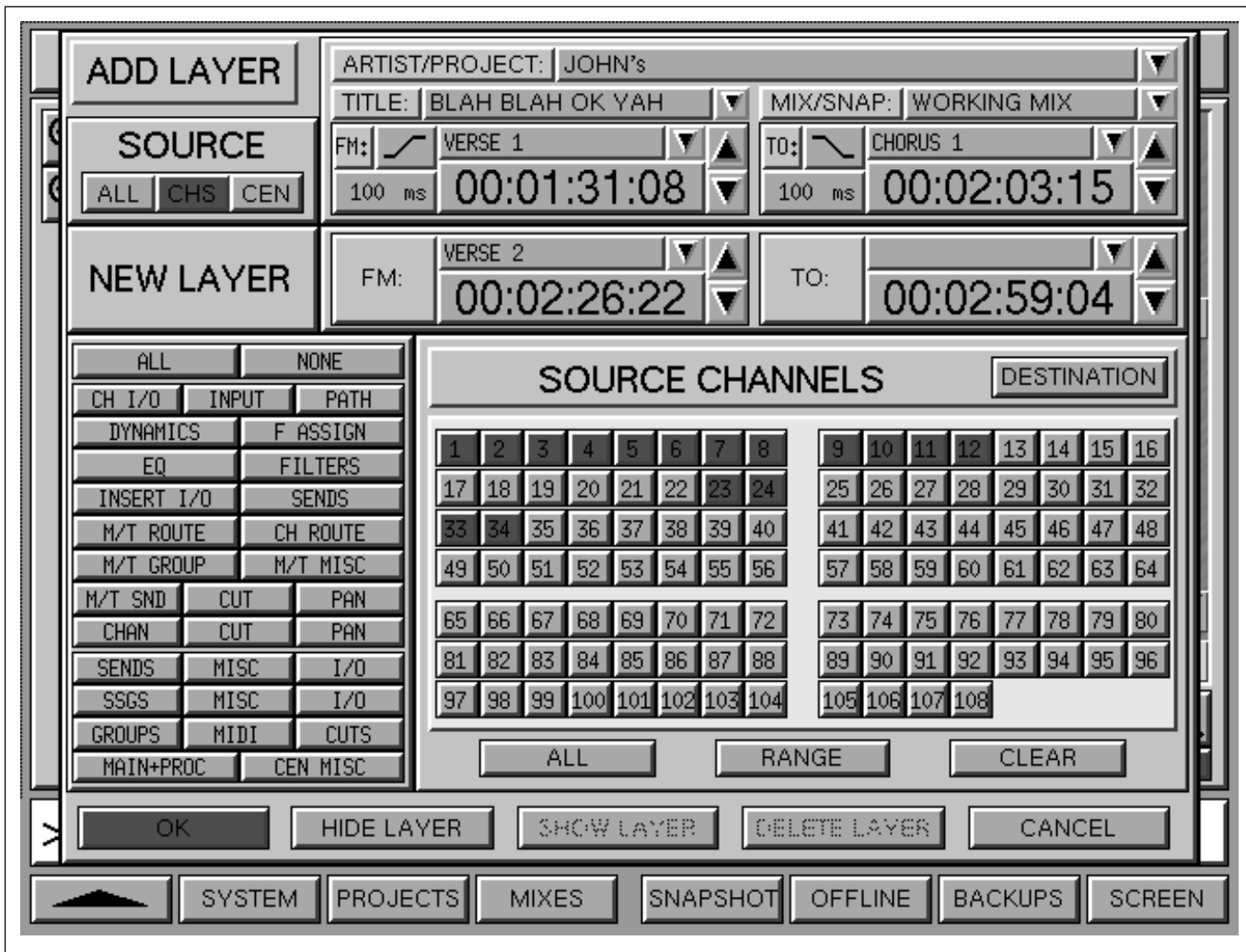

MERGE/ASSEMBLE - ADD LAYER pop-up

in the 'FM' section for a different 'from' point as a Cue point or click on the timecode entry for an edit pop-up. Clicking on the large ▲ and ▼ buttons nudges the timecode. The merge transition can be selected as a butt or timed ramp according to the icon to right of the 'FM' label.

- 5 An end time must be specified in the SOURCE 'TO' section using a similar method used to set the start time, specified in step 4. In this example it is 'CHORUS 1', which is effectively the end of Verse 1.
- 6 A destination within the Working Mix must be specified in the NEW LAYER 'FM' section. The procedure is a repeat of step 4 but without needing to specify a butt or ramp. In the example it is 'VERSE 2'. Once a from ('FM') time is specified the 'TO' time is entered automatically. The 'TO' entry itself can be edited if required.
- 7 Further options include selecting the components in the merge, the default being ALL which includes all channels (CHS) and the centre section (CEN). The example shows that CHS has been selected in the SOURCE block upper left.
- 8 The selection process can be taken further to select specific channels by clicking on the numbered buttons. The example shows that channels 1-12, 23, 24, 33 and 34 have been selected. The source data will be applied to the same numbered channels but can be specified differently by clicking on DESTINATION.
- 9 A further option, the field at left lower middle, allows individual channel and centre section components to be specified by highlighting them.
- 10 **ENTER** or click on OK to complete the merge.

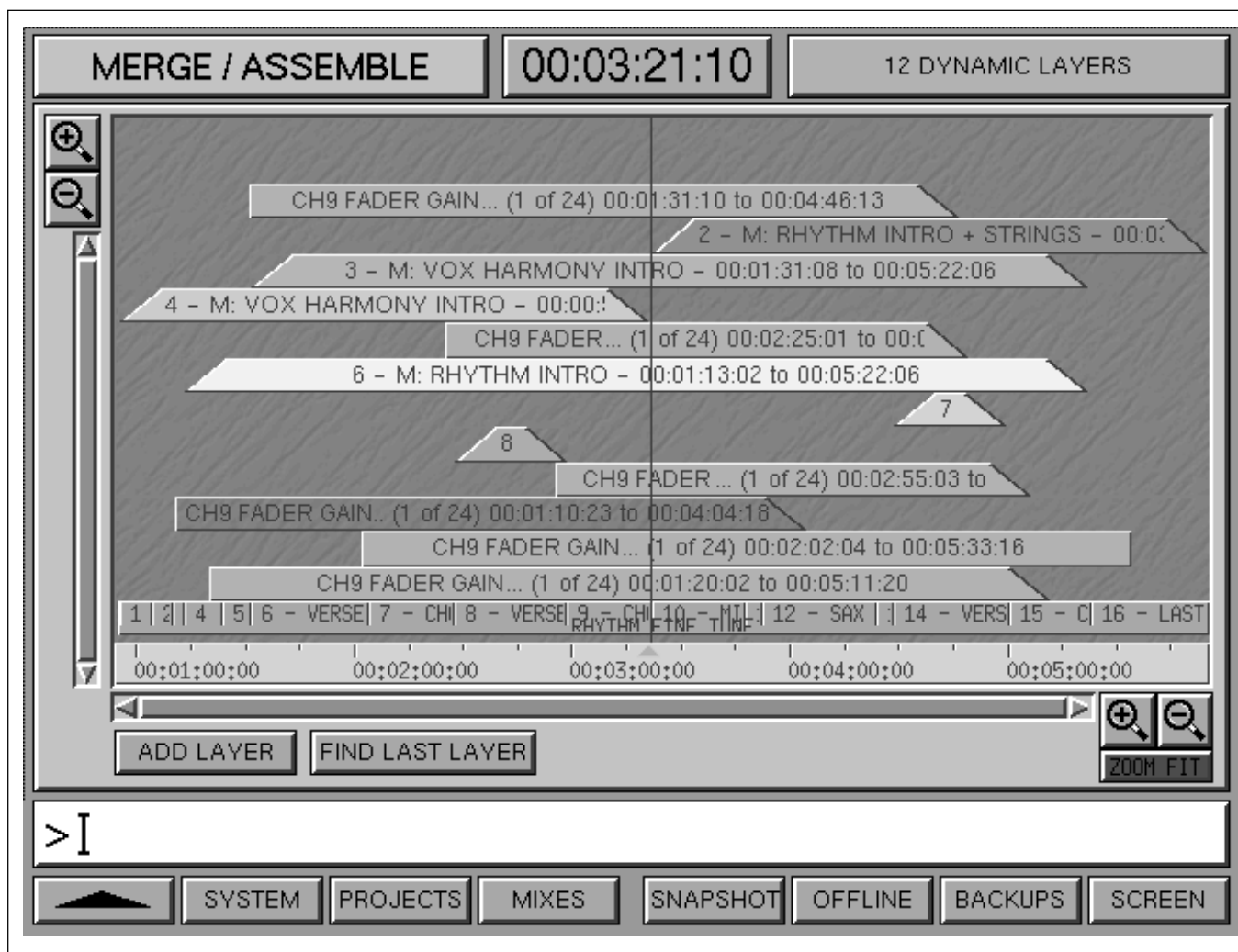

Multiple layers of different types on the MERGE/ASSEMBLE screen

### Layer types

There are four categories of layers, colour coded as:

- **WORKING MIX - Blue**

This is the current underlying base mix accessed by clicking on ADD LAYER. New layers taken from the Working Mix are specified using the ADD LAYER GUI. Click on to edit.

- **DYNAMIC LAYER - Cyan**

This type of layer is created by automating controls on the control surface, such as faders and cuts, in the normal way and cannot be edited.

- **MIX LAYER - Green**

This type of layer consists of dynamic data from other mixes from anywhere except the Working Mix. In other words, mix data from other mixes in the current or any other Title. It is specified using the ADD LAYER GUI. Click on to edit.

- **SNAPSHOT LAYER - Yellow**

This type of layer consists of static data from any Snapshot but must have 'FM' (from) and 'TO' times specified. It is specified using the ADD LAYER GUI. Click on to edit.

### UNDO and REDO

Use the **UNDO** and **REDO** keys on the Control Keyboard to undo and redo layers.

### HIDE or DELETE Layers

Click on any layer for a pop-up. Click on HIDE LAYER or DELETE LAYER as appropriate. The data for a hidden layer will not have any effect on what is heard.

### SAVE

**SAVE MIX** or **SAVE MIX AS NEW** on the Control Keyboard will collapse all layers into a single entity.

# 7-6 The Session Management™ Screen Pages

## 7-6-1 The Start-up Logo Screen

When the system is booted the OXF-R3 logo screen is displayed once the start-up processes are completed.

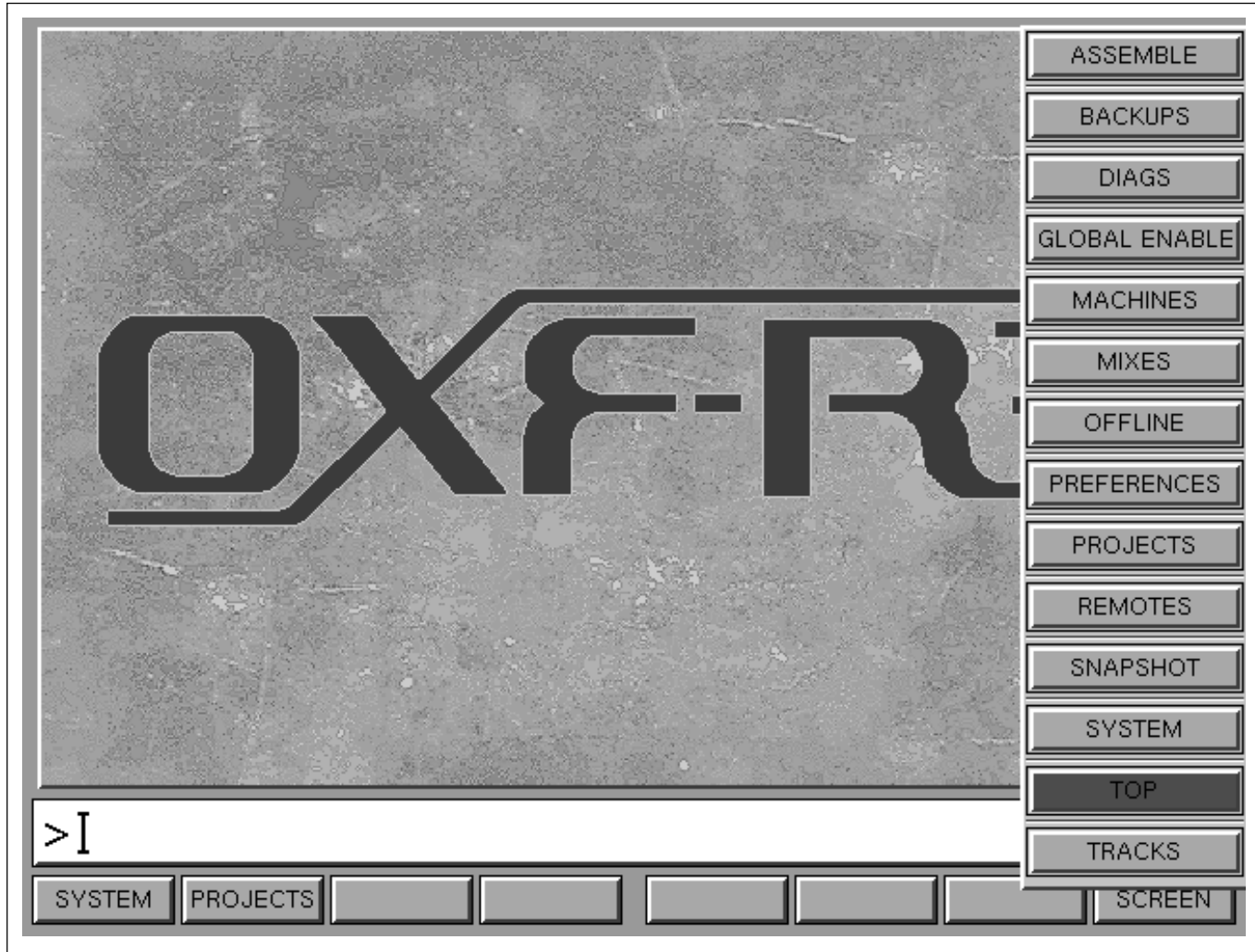

OXF-R3 LOGO with SCREEN pop-up

### General

At the lower part of the screen, note the User Command Dialogue Line bar, which displays commands from the dedicated Control Keyboard and QWERTY Keyboard before entry.

Use the softkey functions at the base of this screen to select one of three menu options:

### SYSTEM softkey

Press this softkey to access the SYSTEM screen page on the Session Management™ Screens, giving access to system set-up and peripheral function options.

### PROJECTS Softkey

Press this softkey to select the ARTISTS/PROJECTS & TITLES page and all other mixing functions.

### SCREEN Softkey

Press this softkey to access a pop-up, as shown, displaying all available screen selections. Click on any one to select it or, alternatively, use the ▲ and ▼ keys on the Control Keyboard to move the highlight and **ENTER**.

### Note:

*Other softkeys are not used on this screen page.*

## 7-6 The Session Management™ Screen Pages

### 7-6-2 The System Screen

The SYSTEM screen allows the set-up of various parameters most of which are session related. The cursor is able to indicate which fields can be edited by changing shape or direction (according to which cursor type has been selected) as it is moved around the screen.

The screenshot shows the 'SYSTEM' screen page. At the top, the word 'SYSTEM' is centered in a large font. Below this, the screen is divided into several sections. On the left, there are eight rows of parameter fields, each with a label and a value: 'Date: 25 May 1999', 'Time: 15:14', 'User: ADMIN', 'TIME DISPLAY TYPE: TIMECODE', 'MACHINE LOCKING: NORMAL', 'TIMECODE FORMAT: PAL (25)', 'MACHINE CONTROLLER: MOTIONWORKER (Perfect)', and 'SELECT CURSOR: BANANA'. On the right side, there are two buttons: 'RELOAD DATABASE' and 'SYSTEM SHUTDOWN'. Below these buttons is a 'SAMPLE RATE' section with three sub-fields: 'NOMINAL RATE: 48000', 'ACTUAL RATE: 48000', and 'MODE: NOMINAL'. At the bottom of the screen, there is a navigation bar with a left arrow and a vertical bar icon, followed by buttons for 'PROJECTS', 'MIXES', 'MACHINES', 'REMOTES', 'SNAPSHOT', 'BACKUPS', and 'SCREEN'.

SYSTEM screen page

#### Date

Displays today's Date which is set automatically.

#### Time

Displays the current Time which is set automatically.

#### User

Displays the current User name. Click on it for a pop-up to select or enter an alternative User. Passwords may be entered by Users. New passwords are required to be entered twice, a second time for confirmation.

The pop-up also allows projects to be assigned to Users or deleted from their 'accounts'. This operation may be carried out only by the User 'ADMIN'.

#### TIME DISPLAY TYPE

Click on to select either Timecode or Bars and Beats.

#### MACHINE LOCKING

This field is generally set to NORMAL for 'legal' automation operation but allows a NON-LOCKING option. This option may be used where full machine synchronisation lock-up may not be possible.

## TIMECODE FORMAT

Displays the current timecode format. Click on it for a pop-up to set an alternative timecode format.

For the system to function correctly, the TIMECODE FORMAT selected here must match the incoming timecode. ***IMPORTANT!***

## MACHINE CONTROLLER

Displays the current Machine Control mode. Click on to select an alternative from:-

- MOTIONWORKER (STANDARD)
- MOTIONWORKER (PERFECT)
- NONE - TIMECODE CHASE ONLY

## SELECT CURSOR

Displays the current cursor format. Click on it for a pop-up to select an alternative.

## RELOAD DATABASE

This function is only available to User 'ADMIN' and is not used during normal operation. It allows the database to be re-loaded from the system hard drive.

## SYSTEM SHUTDOWN

This function is available to User 'ADMIN' only and must be confirmed via a dialogue pop-up.

## SAMPLE RATE

The Sample Rate must match the incoming word clock. ***IMPORTANT!***

## NOMINAL RATE

Displays the current selected Sample Rate. Click on for a pop-up to select an alternative.

## ACTUAL RATE

Displays the Actual Rate of the incoming word clock.

## MODE

Displays the current Sample Rate Mode. Click on to select:

- **NOMINAL**  
When filters and oscillators within the system are fixed at their absolute frequencies regardless of the incoming word clock frequency.
- **TRACK**  
When filters and oscillators within the system track the incoming word clock frequency.

## Command Dialogue

At the base of the screen, the User Command Dialogue Line bar displays commands from the dedicated Control Keyboard and QWERTY Keyboard for confirmation before **(ENTER)**.

## Menu options

Menu options available using the softkey functions displayed at the base of the System screen page are as follows:

- ▲ - Selects the previous screen page.
- PROJECTS** - Selects the ARTISTS/ PROJECTS & TITLES page directly.
- MIXES** - Selects the MIXES & CUES page for all mixing functions.
- MACHINES** - Selects the MACHINES set-up parameters page.
- REMOTES** - Selects the MACHINE REMOTES assignment matrix.
- SNAPSHOT** - Selects the SNAPSHOTS, COPY & LINK page.
- BACKUPS** - Selects System BACKUPS function.
- SCREEN** - Selects pop-up showing all available screen selections. Click on any one to select it.



- 3** Click on the button to the right of the **M** for a pop-up allowing assignment of the new machine to one of the Motionworker channels A-E.

### Multitrack Machines and Track Lists

Machines 1 and 2, labelled MT1 and MT2 in the GUI, are designed for primary multitrack machine use and have track lists associated with them. The names entered in the track lists can be propagated to the electronic scribbles.

### Command Dialogue

At the base of the screen, the User Command Dialogue Line bar displays commands from the dedicated Control Keyboard and QWERTY Keyboard for confirmation before **ENTER**.

### Menu options

Menu options available using the softkey functions displayed at the foot of the Machines screen page are as follows:

- |                 |   |  |
|-----------------|---|--|
| <b>▲</b>        | - | Selects the previous screen page.  |
| <b>SYSTEM</b>   | - | Selects the SYSTEM Screen page directly.   |
| <b>PROJECTS</b> | - | Selects the ARTISTS/PROJECTS & TITLES page directly.                                   |
| <b>MIXES</b>    | - | Selects the MIXES & CUES page for all mixing functions.                                |
| <b>SNAPSHOT</b> | - | Selects the SNAPSHOTS, COPY & LINK page.   |
| <b>TRACKS</b>   | - | Selects the TRACK LISTS page.  |
| <b>REMOTES</b>  | - | Selects the MACHINE REMOTES assignment matrix.   |
| <b>SCREEN</b>   | - | Selects pop-up showing all available screen selections. Click on any one to select it. |

## 7-6 The Session Management™ Screen Pages

### 7-6-4 Artists/Projects & Titles Screen

The ARTISTS/PROJECTS & TITLES screen allows access to all entries belonging to the current User. Clicking on or highlighting any individual ARTIST/PROJECT causes all its TITLES to be displayed.

ARTISTS/PROJECTS	
NEW	ARTISTS/PROJECTS
▲	22 PROJECT 1
	23 PROJECT 2
	24 SLOW DOWN RECORDS
	25 FULL MOON
	26 HER PROJECT
	27 HENLEY JAZZ
▼	28 DAD'S FIRST

NEW	TITLES	START	END
▲	1 IN MY LIFE	00:06:13:21	00:10:34:07
	2 FOLLOW MY DREAMS	00:11:02:23	00:15:45:09
	3 TOO SOON TO KNOW	00:16:24:13	00:19:35:17
	4 BLAH BLAH OK YAH	00:00:54:07	00:05:54:00
	5 GONNA BE ALL RIGHT	00:25:33:14	00:30:32:02
	6 AT LAST	00:31:19:01	00:36:51:09
▼	7 FIRST TIME LOVE	00:38:03:11	00:43:16:06

ARTISTS/PROJECTS & TITLES screen page

#### Upper left status block

Displays the current Artist/Project, the current Title and User.

#### ARTISTS/PROJECTS field

The ARTISTS/PROJECTS field displays all available entries according to the permissions of the current User.

The Titles belonging to the highlighted entry will be displayed in the TITLES field. The highlight may be moved to a different Artist/Project, either by moving the cursor with a Trackerball and clicking, or by nudging the highlight using the cursor keys.

#### Note:

*This must be done with the orange highlight. If, for any reason, the orange highlight is in the Titles field, use one of the Tab (▲ & ▼) keys to the left and right of the up arrow, on the Control Keyboard, to move it into the ARTISTS/PROJECTS field.*

To view Artists/Projects entries above or below those currently displayed in the field, use the adjacent Scroll Bar or the ▲ and ▼ cursor keys on the Control Keyboard.



**To enter a new Artist/Project**

Click on NEW or **PROJECT** **ENTER** on the Control Keyboard for a pop-up to name a new Artist/Project. Type in a name using the QWERTY keyboard and press **ENTER** or click on OK. **ENTER** or OK without a name will enter the next default number.

**To edit the name of an Artist/Project**

Move the highlight to that entry and click, or press **EDIT** on the Control Keyboard to display a pop-up dialogue box. Type in a name using the QWERTY keyboard and press **ENTER** or click on OK.

**To re-order an Artist/Project entry**

Click on its number in the left hand column for a pop-up. Overwrite the current number using the numeric pad on the Control Keyboard, and press **ENTER** or click on OK. The list will re-order itself.

**Entering Notes for an Artist/Project**

Click on the right hand column, or highlight and press **EDIT** on the Control Keyboard, for the NOTES pop-up related to the Artist/Project on the same line. Use the QWERTY Keyboard to enter notes and press **ENTER** or click on OK. The icon appears only if there is a Notes entry.

**TITLES field**

This field displays all Titles under the currently selected Artist/Project. The Start and End times for each Title represent the periods for which automation data will be stored. The times can be adjusted to increase or decrease the time periods, at any time.

**To enter a new Title**

Click on NEW or **PROJECT** **ENTER** on the Control Keyboard for a pop-up to name a new TITLE. Type in a name using the QWERTY keyboard and press **ENTER** or click on OK. **ENTER** or OK without a name will enter the next default number.

**To edit a Title name**

Highlight and click on the name or press **EDIT** on the Control Keyboard to display a pop-up dialogue box. Type in a name using the QWERTY keyboard and press **ENTER** or click on OK.

**To re-order a Title entry**

Click on its number in the left hand column for a pop-up. Overwrite the current number using the numeric pad on the Control Keyboard, and press **ENTER** or click on OK. The list will re-order itself.

**To set the Start Time for a Title**

To set the Start time, highlight the START column at the appropriate line. Click on the highlighted time or press **EDIT** on the Control Keyboard and type in the time. Then **ENTER** or click on OK.

**Using the Numeric Key-pad to Enter Timecode**

The entry format is exactly the same as that used for PCM-3324/48 series remote control units:

1	=	00:00:01:- -
12	=	00:00:12:- -
1234	=	00:12:34:- -
12345	=	01:23:45:- -
123456	=	12:34:56:- -
12345621	=	12:34:56:21
12:34:56:21	=	12:34:56:21
12:34:56	=	12:34:56:- -

**Timecodes shortforms:**

::	Separates hours/minutes
:	Separates minutes/seconds
.	Separates seconds/frame
12::	= 12:00:00:00 Specifies hours
34:	= 00:34:00:00 Specifies minutes
56	= 00:00:56:00 Specifies seconds
.21	= 00:00:00:21 Specifies frames

**To set the Start Time 'On the Fly'**

To set the START time 'on the fly', roll the tape and press **NOW** on the Control Keyboard at the appropriate moment. Roll back and repeat if incorrect. (The time pop-up is not required for this method).

**To set the End Time for a Title**

To set the END time, highlight the END column at the appropriate line, then follow the same procedure as described above for setting the Start time. Typing in the timecode or setting the time 'on the fly' works in the same way.

**Entering Notes for a Title**

Click on the column to the right of the Title, or highlight and press **EDIT** on the Control Keyboard, for the NOTES pop-up related to the Title on the same line. Use the QWERTY Keyboard to enter notes and press **ENTER** or click on OK. The icon appears only if there is a Notes entry.

**Note:**

*Start and End times will be automatically propagated to the Cues list as the first and last cue points for the Title.*

## 7-6 The Session Management™ Screen Pages

Highlight and click on or press **EDIT** for edit pop-ups for the following banners:

### Client

Enter the Client's name here for reference purposes if required. This relates to the current Title only.

### Producer

Enter the name of the Producer for the current Title.

### Engineer

Enter the name of the Engineer for the current Title.

### Assistant

Enter the name of the Assistant Engineer for the current Title.

### Sample Rate

Click on for a pop-up to set the Sample Rate for the current Title. Click on the one which is correct for the incoming word clock. **IMPORTANT!**

### Timecode Type

Click on for a pop-up to set the Timecode type for the current Title. It must match the incoming timecode for the system to function correctly. **IMPORTANT!**

### Tempo Map

Click on **EDIT** for the MIDI Tempo Map pop-up. Details of how to enter and edit the Tempo Map are described in the section on MIDI.

### Date

Displays today's date.

### Command Dialogue

At the base of the screen, the User Command Dialogue Line bar displays commands from the dedicated Control Keyboard and QWERTY Keyboard for confirmation before **ENTER**.

### Menu options

Menu options available using the softkey functions displayed at the foot of the Artists/Projects & Titles screen page are as follows:

- ▲ - Selects the previous screen page.
- SYSTEM** - Selects the SYSTEM screen page directly.
- MIXES** - Selects the MIXES & CUES page for all mixing functions.
- SNAPSHOT** - Selects the SNAPSHOTS, COPY & LINK page.
- REMOTES** - Selects the MACHINE REMOTES assignment matrix.
- TRACKS** - Selects the TRACK LISTS page.
- BACKUPS** - Selects System BACKUPS functions.
- SCREEN** - Selects pop-up showing all available screen selections. Click on any one to select it.

## 7-6-5 Mixes & Cues Screen

This screen page displays all the Mixes & Cues which relate to the current title.

<b>MIXES &amp; CUES</b>		RAMP TIME: 1000 ms	PRE-ROLL: 3 sec
TITLE: BLAH BLAH OK YAH		MIX:	■ PARKED
START TIME: GUITAR PICS	00:02:17:00	END TIME: PRE SOLO BREAK	
00:01:04:02		00:03:46:23	

MIXES	NEW	CUES	TIME
1 RHYTHM INTRO	1	START OF TITLE	00:00:54:21
2 GUITAR INTRO	2	GUITAR PICS	00:01:04:02
3 KIT INTRO	3	GUITAR INTRO	00:01:09:13
4 VOX HARMONY INTRO	4	KIT INTRO	00:01:13:02
5 LEAD VOX INTRO	5	VOX INTRO	00:01:23:02
6 RHYTHM INTRO + STRINGS	6	VERSE 1	00:01:31:08
7 KEYS UP TO KEY CHANGE	7	CHORUS 1	00:02:03:15
8 LEAD VOX	8	VERSE 2	00:02:26:22
9 RHYTHM	9	CHORUS 2	00:02:58:03
10 SAX SOLO	10	MIDDLE 8	00:03:21:07
11 BACK VOX	11	PRE SOLO BREAK	00:03:46:23
12 LEAD VOX FINE TUNE	12	SAX SOLO - VERSE	00:03:51:24
13 RHYTHM FINE TUNE	13	KEY CHANGE	00:04:23:01

>I

▲
SYSTEM
PROJECTS
SNAPSHOT
ASSEMBLE
TRACKS
OFFLINE
SCREEN

MIXES & CUES screen page

**TITLE and MIX bar**

Displays the name of the current Title and current Mix.

**Machine status bar**

Situated to the right of the TITLE and MIX bar, this field indicates the current operational status of the timecode master machine e.g. PLAYING, FAST WIND, FAST REWIND, STOPPED, PARKED.

**RAMP TIME bar**

(Relates to the RAMP button, beneath the central LCD) This banner shows the Ramp Time currently set for faders to slew to previous levels when joining/editing mixes, or dropping out of automation record when

current and previous fader levels do not match. To set the Ramp Time, highlight the field then click on, or press **[EDIT]** on the Control Keyboard. It may be set at between 1ms and 10s to a resolution of 1ms.

**PRE-ROLL bar**

The Pre-roll time in seconds is displayed here. When locating to a specific timecode point, the machine parks ahead of that time by the value set in this field. Highlight the field then click on, or press **[EDIT]** on the Control Keyboard, to obtain its pop-up to set or adjust the Pre-Roll time.

## 7-6 The Session Management™ Screen Pages



MIXES & CUES screen page

### Central large timecode display

Displays the current timecode for the master machine.

### Automation status bar (top right)

Indicates whether there is any static or dynamic data in the system memory that could be saved to the hard drive. If the bar is blank then there is nothing to save.

#### • STATIC DATA

Indicates that some non-automated controls have different static settings compared to the current mix and that those settings can be saved.

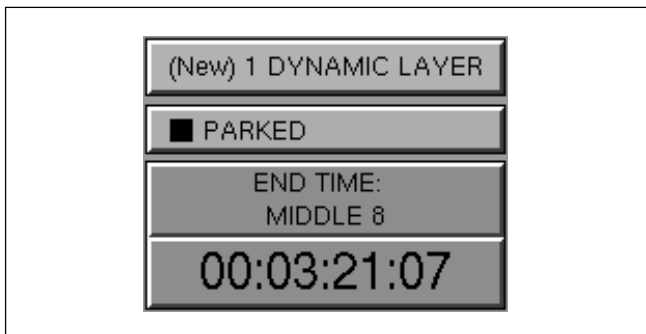

#### • (New) # DYNAMIC LAYER

Indicates that some unsaved automated moves are in memory. The # indicates how many layers have been made.

### START TIME

Located to the left of the large timecode display, this field indicates the start time from where the tape will roll or has rolled or cycled from. If a cue has been specified, its name or default number will be displayed instead, e.g.

**PLAY** **CUE 2** **CUE 11** **ENTER**

#### Note:

If a Pre-Roll time is defined, the START TIME field will take account of this in the time it displays.

### END TIME

Located to the right of the large timecode display, this field indicates which timecode point the tape will roll to or cycle back from, if a cycle command has been specified.

### MIXES

This field, occupying most of the left side of the screen page, displays any mixes that have been saved. The date and time indicates when the currently highlighted mix was created.

As soon as any automated functions have been actioned, 1 DYNAMIC LAYER appears above the large central timecode display indicating a 'Working Mix' is resident in memory. The number will be set according to the number of mix passes and will be affected by UNDO and REDO functions. In other words, automation data exists which has not yet been saved i.e. the tape has been rolled with some faders, switches or knobs in Write. To save a mix, press **SAVE** **MIX** **ENTER** on the Control Keyboard and a pop-up appears with a text line to type in an appropriate name. Press **ENTER** for the default name of MIX 1 for the first mix, or type in a name and press **ENTER**. The DYNAMIC LAYER flag will then disappear.

If a trim or more automated actions are made, the DYNAMIC LAYER flag appears once more. If the **SAVE** **MIX** **ENTER** procedure is followed again, the new data will overwrite the previous mix in the same manner as the SAVE function works on a normal word processor. Use **SAVE** **MIX** **AS NEW** **ENTER** instead, to avoid overwriting the previous mix. The name pop-up will appear as before.

When a mix is saved, so are the static settings of the complete console. If the mix is recalled at a later date, everything will be completely reset to previous static positions, apart from controls which were automated. They will assume their settings according to timecode.

If an attempt is made to load another mix whilst the DYNAMIC LAYER flag is displayed, the user will be prompted to save the current mix data, via a pop-up. This will be indicated in the MIXES list as 'Working Mix Saved' with the next default number. Enter a name instead if desired.

The automation can be turned off during mixing using the command **MAKE STATIC** **ENTER** on the Control Keyboard. A dialogue box will warn that dynamic moves will be lost. In this case, a STATIC MIX will be saved with the next default number. From this point, all controls will behave as if no mix has been recorded e.g. faders will not snap back.

This function is very useful for making a fresh start on a mix with a new starting balance. To go back later to a previous mix, move the highlight to it and select **LOAD** **MIX** **ENTER** on the Control Keyboard. If unsaved data exists, as always, the user will be prompted to save it.

If any changes are made to any un-automated controls, the STATIC DATA flag will highlight this. If the user tries to load another mix, a pop-up will ask if this data should be saved, even though it is for static controls. To delete a mix, highlight the mix in the MIXES field, then select **DELETE** **MIX** **ENTER** on the Control Keyboard. Alternatively, select **DELETE** **MIX** # **ENTER**. A confirmation prompt will appear.

Click on the right hand column, or highlight and press **EDIT** on the Control Keyboard, for the NOTES pop-up related to the mix on the same line.

### To edit a Mix name

Highlight and click on the name or press **EDIT** on the Control Keyboard to display a pop-up dialogue box. Type in a name using the QWERTY keyboard and press **ENTER** or click on OK.

### To re-order a Mix entry

Click on its number in the left hand column for a pop-up. Overwrite the current number using the numeric pad on the Control Keyboard, and press **ENTER** or click on OK. The list will re-order itself.

### Partial Loading of Mixes

This function allows the loading of specified channels or parts of channels according to the SNAPSHOT DEFAULTS. Select the SNAPSHOTS, COPY and LINK GUI to view SNAPSHOT DEFAULTS (see section 7-6-8).

#### Note:

All the following command lines apply to the currently **highlighted mix** in the MIXES & CUES GUI.

### Commandlines

The commands for loading Partial Dynamic Mixes are all carried out using the Control Keyboard (see section 6-3-3).

**LOAD** **1..8** **MIX** **ENTER**

This command will load mix data for Channels 1-8.

**LOAD** **1.3.5.7.9.11** **MIX** **ENTER**

This command will load mix data for Channels 1, 3, 5, 7, 9 and 11.

**LOAD** **01..08** **MIX** **ENTER**

This command will load mix data for Control Group Faders 1-8.

**LOAD** **019** **MIX** **ENTER**

This command will load mix data for a single Control Group Fader 19.

**LOAD** **00** **MIX** **ENTER**

This command will load mix data for the central Main Fader.

### MIX AUTO-SAVE

The OXF-R3 system saves backup mixes automatically. The default settings are for 3 mixes to be saved in rotation, one every 2 minutes. The time can be varied from 1 to 60 minutes between saves, with between 1 and 10 mixes. The settings can be adjusted in the 'config file'.

To load the most recent Auto-Save mix:

**LOAD** **MIX** **0** **ENTER**

Substitute '-1' for the '0' to load the second most recent and '-2' for the third most recent.

## 7-6 The Session Management™ Screen Pages

**MIXES & CUES** RAMP TIME: 9732 ms PRE-ROLL: 0 sec (New) 1 DYNAMIC LAYER

TITLE: BLAH BLAH OK YAH MIX:  PARKED

START TIME: GUITAR PICS 00:01:04:02 **00:02:06:15** END TIME: MIDDLE 8 00:03:21:07

MIXES	NEW	CUES	TIME
14:59 03 Jun 1998			
1 RHYTHM INTRO	1	START OF TITLE	00:00:54:21
	2	GUITAR PICS	00:01:04:02
	3	GUITAR INTRO	00:01:09:13
	4	KIT INTRO	00:01:13:02
	5	VOX INTRO	00:01:23:02
	6	VERSE 1	00:01:31:08
	7	CHORUS 1	00:02:03:15
	8	VERSE 2	00:02:26:22
	9	CHORUS 2	00:02:58:03
	10	MIDDLE 8	00:03:21:07
	11	PRE SOLO BREAK	00:03:46:23
	12	SAX SOLO - VERSE	00:03:51:24
	13	KEY CHANGE	00:04:23:01

> PLAY MIX

SYSTEM PROJECTS SNAPSHOT ASSEMBLE TRACKS OFFLINE SCREEN

MIXES & CUES screen page illustrating the CUES list

### CUES field

Cue points are specific listed time points within a Title. They are automatically numbered (in sequence) for quick reference and may be given appropriate names. Cue points may be added by explicitly typing them in or 'on the fly' as the tape is rolling.

Start of Title and End of Title cues are propagated automatically from the Artists/Projects & Titles screen entry. If these times are adjusted on the Mixes & Cues screen page, the changes will automatically be propagated back to the Artists/Projects & Titles page.

#### Note:

*The Start of Title and End of Title cues cannot be deleted.*

### To set CUE Points

To set a cue point offline, press **[CUE]** **[ENTER]** on the Control Keyboard or click on NEW in the Cues list title bar for a pop-up to name a new cue. Type in a

name using the QWERTY keyboard and press **[ENTER]** or click on OK. **[ENTER]** or OK without a name will enter the next default. The TIME column will take on the timecode position of the master machine indicated by the large central timecode display at the time **[ENTER]** is pressed or NEW is clicked on.

To edit the time for a cue offline, move the highlight to the desired line in the TIME column at the right side of the screen page, and click on it or press **[EDIT]** on the Control Keyboard. The timecode pop-up will be displayed. Type in the timecode and click on **OK** or press **[ENTER]**.

Alternatively, move the orange highlight into the TIME column and press **[NOW]** on the Control Keyboard at the appropriate timecode point, either with the tape rolling or stopped.

### To set Cue Points ‘On the Fly’

To set a cue point ‘on the fly’, roll the tape and press **[CUE]** on the Control Keyboard, in readiness for setting a cue point.

At the appropriate time, press **[ENTER]** and a cue point will be added at the time **[ENTER]** is pressed. A pop-up will then appear to prompt for a name entry. Either press **[ENTER]** for the next default Cue Number or type in an appropriate name and press **[ENTER]**. Repeat as necessary for any subsequent cues.

The cues scroll automatically with reference to timecode. The current cue is displayed in the central white bar surrounded by black lines. Any commands which specify Start and End times, such as **[CYCLE]**, will cause green highlights to be displayed on those cues.

### Cues List Scrolling

The CUES list scrolls through automatically as the tape is rolling. The current Cue is placed in the middle of the list by default but the SCROLL BAR, to the left of the CUES list, can be used to place the current CUE at the most convenient position. It may be preferable to see more of the approaching CUES than those already passed, for example.

If there is a long list of CUES, some of which are above or below the section being displayed, the SCROLL BAR can be used to view them whilst the tape is stopped. However, the current CUE will always be in view when the tape is rolling. If it is out of view (the tape is stopped) and then the tape is rolled, the current CUE will immediately jump into view.

Click on the CUES list header to reset the list so that the current CUE resides in the centre of the list, which is the default.

### To edit a Cue name

Highlight and click on the name or press **[EDIT]** on the Control Keyboard to display a pop-up dialogue box. Type in a name using the QWERTY keyboard and press **[ENTER]** or click on OK.

### To re-order a Cue entry

Click on its number in the left hand column for a pop-up. Overwrite the current number using the numeric pad on the Control Keyboard, and press **[ENTER]** or click on OK. The list will re-order itself.

### To Delete a Cue

To delete a cue, highlight that cue in the CUES field, then on the Control Keyboard select:

**[DELETE] [CUE] [ENTER]**

or without highlighting it:

**[DELETE] [CUE] # [ENTER]**

### Entering Notes for a Cue

Click on the middle column, or highlight and press **[EDIT]** on the Control Keyboard, for the NOTES pop-up related to the cue on the same line. Use the QWERTY Keyboard to enter notes and press **[ENTER]** or click on OK. The icon appears only if there is a Notes entry.

### Command Dialogue

At the base of the screen, the User Command Dialogue Line bar displays commands from the dedicated Control Keyboard and QWERTY Keyboard for confirmation before **[ENTER]**.

### Menu options

Menu options available using the softkey functions displayed at the foot of the Mixes & Cues screen page are as follows:

- ▲ - Selects the previous screen page.
- SYSTEM** - Selects the SYSTEM screen page directly.
- PROJECTS** - Selects the ARTISTS/PROJECTS & TITLES page.
- SNAPSHOT** - Selects the SNAPSHOTS, COPY & LINK page.
- ASSEMBLE** - Selects the mix compilation MERGE/ASSEMBLE page.
- TRACKS** - Selects the TRACK LISTS page.
- OFFLINE** - Selects OFFLINE faders and cuts automation edit page.
- SCREEN** - Selects pop-up showing all available screen selections. Click on any one to select it.

## 7-6 The Session Management™ Screen Pages

### 7-6-6 Merge/Assemble Screen

The MERGE/ASSEMBLE GUI allows Mixes and Snapshots from any source to be merged with the current Working Mix. Each bar in the GUI represents a Mix Layer and these may include additional Dynamic Layers.

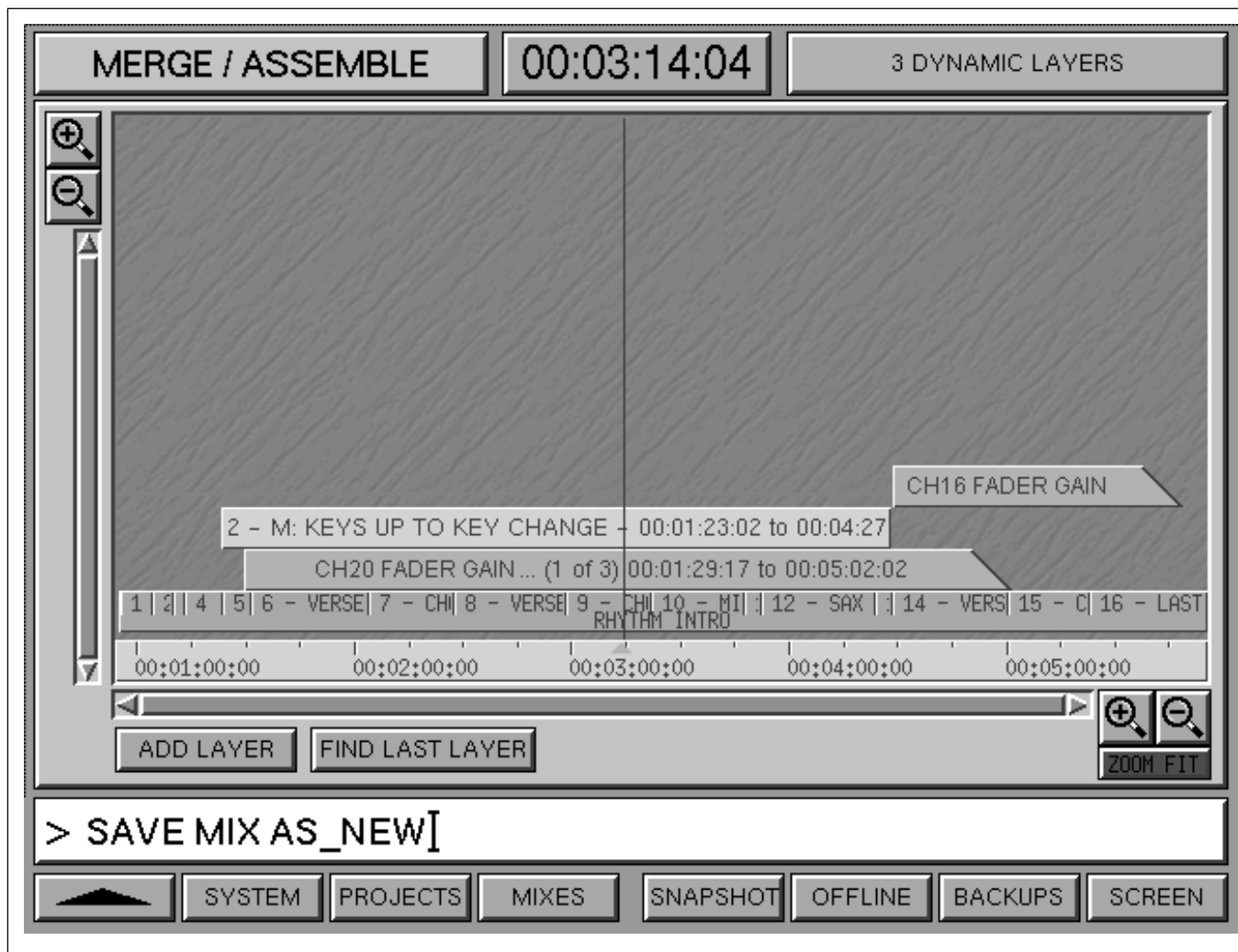

MERGE/ASSEMBLE screen

#### General

This time-line GUI displays the current Working Mix as a blue bar along the bottom of the screen. Cue points are displayed as vertical lines along this bar with labels where possible.

Individual bars for any unsaved additional mix layers will also be displayed as they are created or merged. The most recent will be the uppermost. Any New Dynamic Layers, that is those created by automating controls on the console surface, will appear after creation once the tape is put into rewind.

#### Timecode display

The Timecode display placed centrally at the top of the screen displays the current time for the master machine. The vertical line indicates the related position along the time-line.

#### Mix Layer Status

The banner at the top right indicates the total number of unsaved Mix Layers in the system memory. The **UNDO**, **REDO**, **UNDO ALL** and **REDO ALL** keys on the Control Keyboard can be used to undo and redo layers.



## Scroll and Zoom

The time-line can be scrolled or zoomed in or out using the independent horizontal and vertical Scroll and Zoom icons.

## ZOOM FIT

Highlight ZOOM FIT by clicking on it to have all Mix Layers totally in view. If layers are shortened or extended, the display will adjust accordingly as each layer is completed.

## FIND LAST LAYER

Click on FIND LAST LAYER in cases where the latest mix occurs in a portion of the time-line not in view for the display to shift view accordingly.

## ADD LAYER

Clicking on ADD LAYER causes a large pop-up to appear which divides into two major areas:

### • SOURCE - Specify:

- ARTIST/PROJECT (Current is default)
- TITLE (Current is default)
- MIX or SNAPSHOT (WORKING MIX is default)
- FM Time (can be a Cue Point)
- TO Time (can be a Cue Point)
- Independent Ramp or Butt Joins for FM & TO
- ALL - Complete Console
- CHS - Source Channels (specify which ones)
- CEN - Central Master Section
- Which Channel Sections (e.g. Fader, EQ etc)

### • DESTINATION - Specify:

- FM Time (can be a Cue Point)
- TO Time - Entered Automatically, can be Edited
- CHS - Destination Channels (same # is Default)

## ADD LAYER example

The following example involves copying mix data within a Title from Verse 1 to Verse 2.

**1** Select the source data using the upper section of the GUI. The default source is the current Artist/Project, Title and its Working Mix. The mix data for Verse 1 is already resident in the Working Mix so this is the correct source mix for this example. Any other source can be selected by clicking on the appropriate ▼ to the right of its name strip for a pop-up list.

**2** Having established the correct source, set a start time for the source data in the SOURCE 'FM' section which may be a Cue point or timecode entry. 'VERSE 1' is displayed in the example. Click on ▼ to the right of the name strip in the 'FM' section for a different 'from' point as a Cue point or click on the timecode entry for an edit pop-up. Clicking on the large ▲ and ▼ buttons nudges the timecode. The merge transition can be selected as a butt or timed ramp according to the icon to right of the 'FM' label. The ramp time can be adjusted by clicking the label below the ramp icon for a pop-up.

**3** An end time must be specified in the SOURCE 'TO' section using a similar method to that used to set the start time, specified in step 2. In this example it is 'CHORUS 1', which is effectively the end of Verse 1.

**4** A destination within the Working Mix must be specified in the NEW LAYER 'FM' section. The procedure is a repeat of step 2 but without needing to specify a butt or ramp. In the example it is 'VERSE 2' in order to copy the data from Verse 1 to Verse 2. Once a from ('FM') time is specified the 'TO' time is entered automatically. The 'TO' entry itself can be edited if required.

**5** Further options include selecting the components in the merge, the default being ALL which includes all channels (CHS) and the centre section (CEN). The example shows that CHS has been selected in the SOURCE block upper left.

**6** Specific channels have been selected by clicking on the numbered buttons. The example shows that channels 1-12, 23, 24, 33 and 34 have been chosen. The source data will be applied to the same numbered channels but can be applied to different channels by clicking on DESTINATION.

**7** A further option, the field at left lower middle, allows individual channel and centre section components to be specified. Clicking on ALL will highlight every component whilst clicking on NONE will de-select them all. They can also be selected individually from either starting point. The example shows that PATH, DYNAMICS, EQ, CHAN (Fader) and its CUT have been highlighted.

## 7-6 The Session Management™ Screen Pages

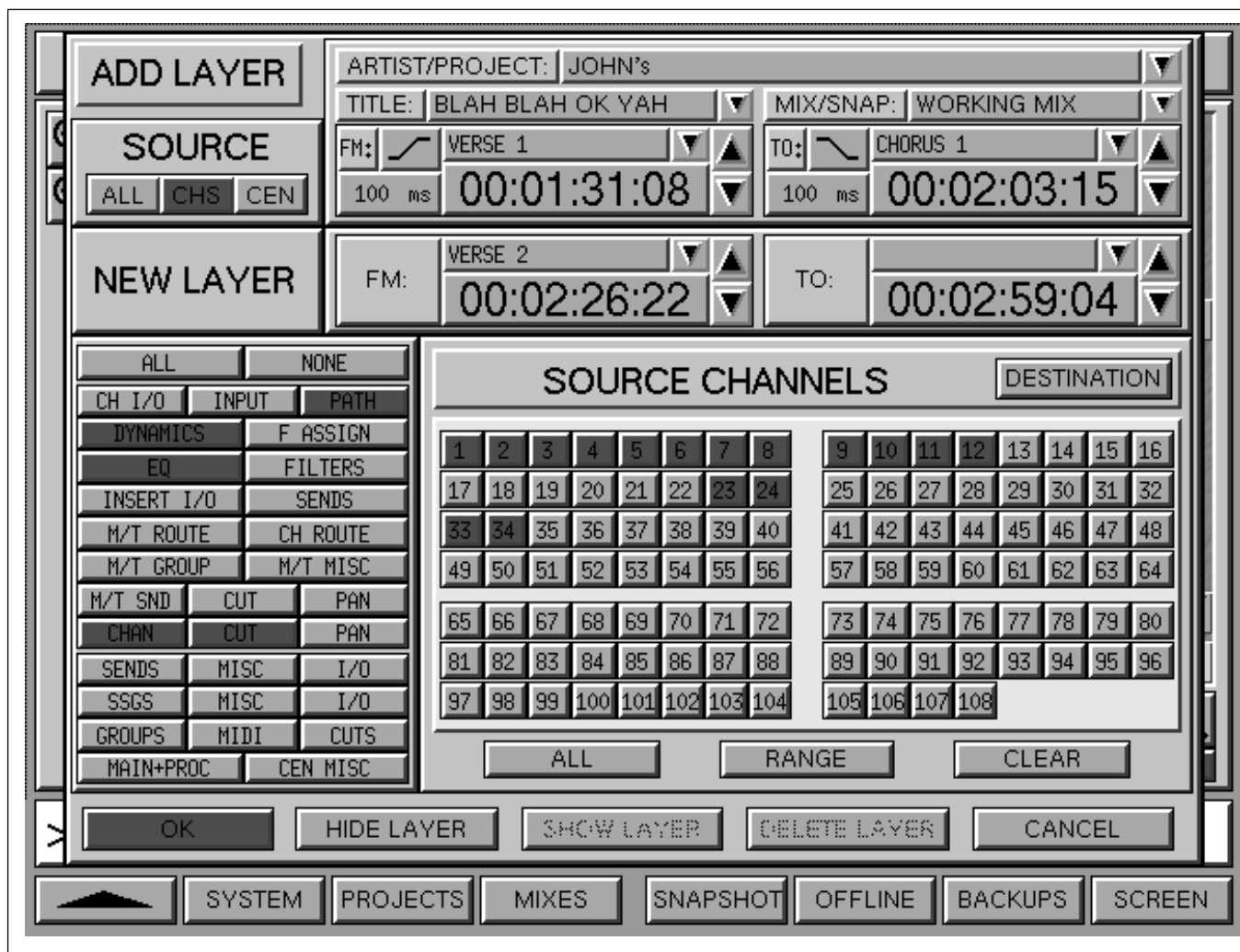

MERGE/ASSEMBLE - ADD LAYER pop-up

### Note

*CHS must be highlighted in the upper left SOURCE box for a selection of channels, and CEN for any centre section components.*

**8** Once the selection process is complete, click on OK or press **(ENTER)** on the Control Keyboard and this new layer will be added to the MERGE/ASSEMBLE screen.

**9** To edit the layer, click on it for its ADD LAYER pop-up and adjust as necessary.

### SOURCE CHANNELS Selector

Channels can be selected individually by clicking on appropriate numbers to highlight them or click on ALL and then de-select individual channels if more convenient.

Click on RANGE to highlight it in order to select contiguous blocks of channels. Then click on the first and last of each block. De-select RANGE when finished.

Click on CLEAR to de-select any highlighted channels.

### DESTINATION

Click on DESTINATION if the automation data is to be applied to different numbered destination channels. Make sure that the number of destination channels selected matches the number of source channels, including multiple blocks.

### HIDE, SHOW and DELETE LAYER

Click on HIDE LAYER or DELETE LAYER as appropriate. The data for a hidden layer will not have any effect on what is heard. Click on SHOW LAYER to bring it back.

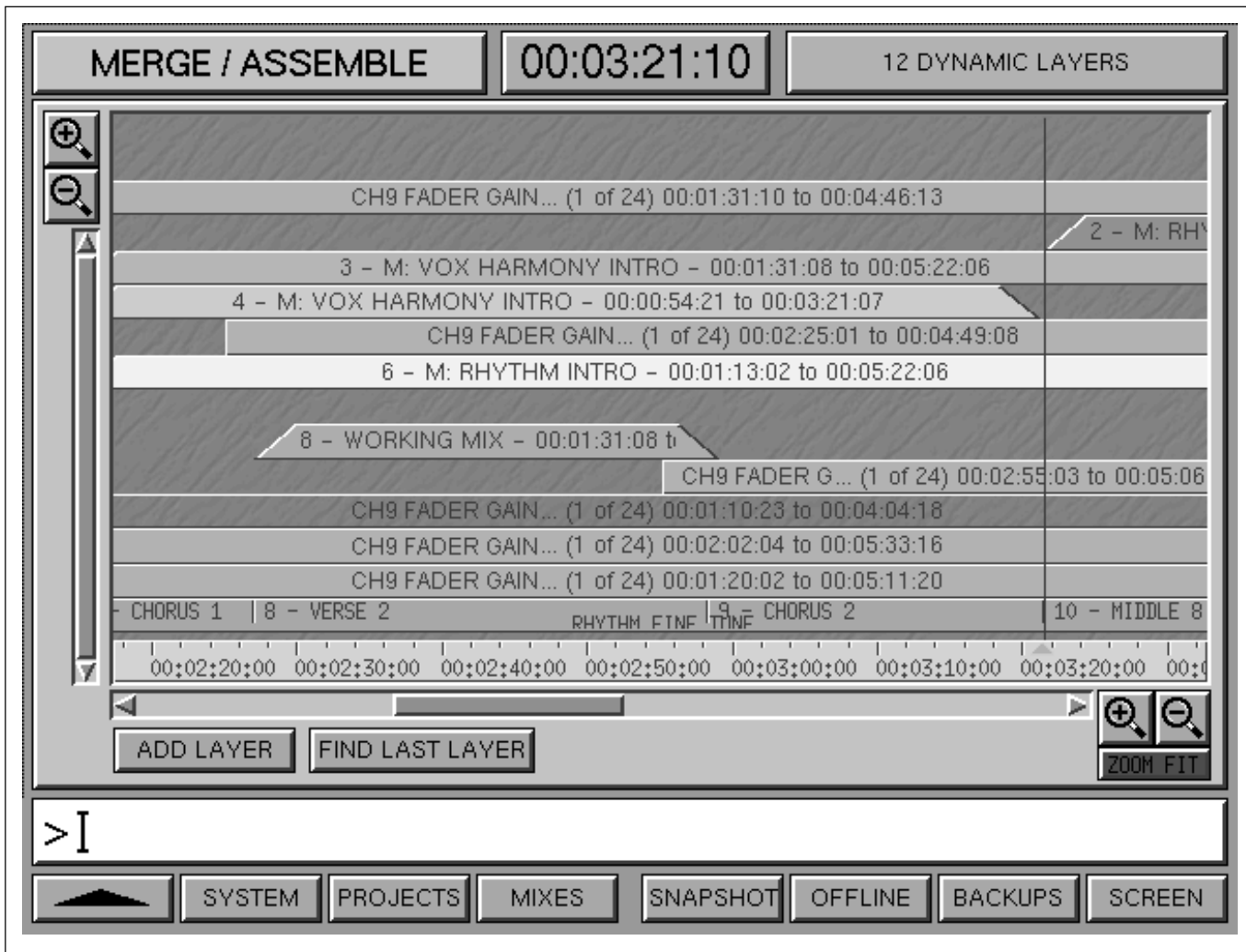

Multiple layers of different types on the MERGE/ASSEMBLE screen

### Layer types

There are four categories of layers, colour coded as:

- **WORKING MIX - Blue**

This is the current underlying base mix accessed by clicking on ADD LAYER. New layers taken from the Working Mix are specified using the ADD LAYER GUI. Click on to edit.

- **DYNAMIC LAYER - Cyan**

This type of layer is created by automating controls on the control surface, such as faders and cuts, in the normal way and cannot be edited.

- **MIX LAYER - Green**

This type of layer consists of dynamic data from other mixes from anywhere except the Working Mix. In other words, mix data from other mixes in the current or any other Title. It is specified using the ADD LAYER GUI. Click on to edit.

- **SNAPSHOT LAYER - Yellow**

This type of layer consists of static data from any Snapshot but must have 'FM' (from) and 'TO' times specified. It is specified using the ADD LAYER GUI. Click on to edit.

### UNDO and REDO

Use the **UNDO** and **REDO** keys on the Control Keyboard to undo and redo layers.

### HIDE or DELETE Layers

Click on any layer for a pop-up. Click on HIDE LAYER or DELETE LAYER as appropriate. The data for a hidden layer will not have any effect on what is heard.

### SAVE

**SAVE MIX** or **SAVE MIX AS NEW** on the Control Keyboard will collapse all layers into a single entity.

## 7-6 The Session Management™ Screen Pages

### Command Dialogue

At the base of the screen, the User Command Dialogue Line bar displays commands from the dedicated Control Keyboard and QWERTY Keyboard for confirmation before **[ENTER]**. There are command line merge functions available alongside the GUI-based assemble described previously.

### MERGE command lines

The merge mix automation data command lines allow specified parts of a saved mix or a snapshot setting to be merged into the current working mix. The parameters which can be specified are:

- which CHANNELS
- which CONTROL GROUP FADERS
- which MIX (including the current working mix) or SNAPSHOT source
- START and END Times from the source mix
- DESTINATION Times for time-shifted merge
- BUTT or RAMP for the merge mix sections
- joining of Static Objects to other Static Objects

The UNDO and REDO functions will work on any merge operations in the normal way.

The constituents of a merge command are as follows:

- 1 **[MERGE]** key on the Control Keyboard.
- 2 **Source:**  
Nothing specified, uses current WORKING MIX  
**[MIX]** = Currently highlighted MIX  
**[SNAPSHOT]** = Currently highlighted SNAPSHOT
- 3 **List or Range of Channels or other Faders:**  
1..108 = Channels 1-108  
01..032 = Control Group Faders 1-32  
00 = Main Fader
- 4 **Start Time for Source Data:**  
**[A]**, **[B]**, Cue, Cue # or Timecode number entry
- 5 **End Time for Source Data:**  
**[A]**, **[B]**, Cue, Cue # or Timecode number entry
- 6 **Optional Shifted Destination Start Time:**  
**[A]**, **[B]**, Cue, Cue # or Timecode number entry
- 7 **[ENTER]**

#### Note:

- 1 Channel data will be merged according to the control types highlighted in the **SNAPSHOT DEFAULTS**.

- 2 Channels and other fader types can be specified in a single string e.g.  
00.01.03.05..08.1..24.48..56.65 =  
Main Fader, Control Group Faders 1, 3, 5-8  
Channels 1-24, 48-56 and 65.
- 3 If Timecode number entry is used, **[TO]** key must be used as a separator - see example below.

### Example MERGE command lines

```
[MERGE] 1..48 [CUE] 3 [CUE] 6 [CUE] 9  
[ENTER]
```

Adds new automation layer to the working mix that copies all the moves for channels 1-48 between Cue 3 and Cue 6 to start at Cue 9.

```
[MERGE] [SNAPSHOT] 1..2 [A] [B] [ENTER]
```

Adds new automation layer to the working mix that will switch to snapshot data at **[A]** and back to existing data at **[B]** for channels 1 and 2.

```
[MERGE] [MIX] 01..032 [TO] 2:00 [TO] 4:00  
[TO] 2:01 [ENTER]
```

Slides the moves on control group faders between 2:00 and 4:00 of highlighted mix to 2:01 on working mix.

---

## Menu options

Menu options available using the softkey functions displayed at the foot of the Merge/Assemble screen page are as follows:

- ▲** - Selects the previous screen page.
- SYSTEM** - Selects the SYSTEM screen page directly.
- PROJECTS** - Selects the ARTISTS/PROJECTS & TITLE page.
- MIXES** - Selects the MIXES & CUES page.
- SNAPSHOT** - Selects the SNAPSHOTS, COPY & LINK page.
- OFFLINE** - Selects OFFLINE faders and cuts automation edit page.
- BACKUPS** - Selects system BACKUP functions.
- SCREEN** - Selects pop-up showing all available screen selections. Click on any one to select it.

## 7-6 The Session Management™ Screen Pages

### 7-6-7 Track Lists Screen

There are two independent Track List pages which are assignable to machines MT1 and MT2 set up using the MACHINES GUI. Track Lists can be imported from other Artist/Projects and Titles.

TRACK LIST 1	MT1	SCRIBBLE	TRACK LIST 1	MT1	SCRIBBLE
1		KICK	25		TROMBONES L
2		SNARE	26		TROMBONES R
3		HIGH HAT	27		KX88 L
4		HIGH TOM	28		KX88 R
5		MID TOM	29		PROTEUS L
6		LOW TOM	30		PROTEUS R
7		FLOOR TOM	31		KURZWEIL L
8		CRASH SYMBOL	32		KURZWEIL R
9		RIDE SYMBOL	33		G/VOX
10		KIT O/HEAD LEFT	34		LEAD VOX 1
11		KIT O/HEAD RIGHT	35		LEAD VOX 2
12		JAZZ BASS 5	36		B/VOX LOW HAR
13		SYNTH BASS	37		B/VOX MID HAR
14		GUITAR L	38		B/VOX HIGH HAR
15		GUITAR R	39		B/VOX FALSETTO
16		RHODES	40		END HARMONY
17		M1 L	41		GUITAR PICKS
18		M1 R	42		PROPHET 5 (DAD!)
19		TRUMPETS L	43		PERCUSSION L
20		TRUMPETS R	44		PERCUSSION R
21		SAXES L	45		HIGH HAT 2
22		SAXES R	46		SNARE UNDER
23		SAX SOLO 1	47		CHIMES
24		SAX END CHORUS	48		BLOCKS

TRACK LISTS page displaying entries for a 48 track machine

#### Track Lists page in general

This page displays two columns with up to 24 entries in each. This allows track lists for two machines simultaneously or different tracks on the same machine in each column. Tracks 1-24 and 25-48 for the same machine are shown as an example in the illustration. The vertical scroll bars are used to scroll the track lists on machines with more than 24 tracks.

#### To select a Track List

The system holds two independent Track Lists, TRACK LIST 1 and 2. Click on the heading banner to alternate between them.

#### To select a Machine

The two track lists may be assigned to Machines MT1 and MT2. Click on MT# to alternate between them.

#### To name Tracks

To name or edit a Track designation, highlight the actual name (not its number in the left hand column) and click on it or press **[TAB]** on the QWERTY keyboard. A large dialogue box appears in which to type the name. Type in a name and use the **↑** and **↓** keys to move to the next entry. Click on **OK** or **[ENTER]** by the numeric keys on the QWERTY keyboard when finished.

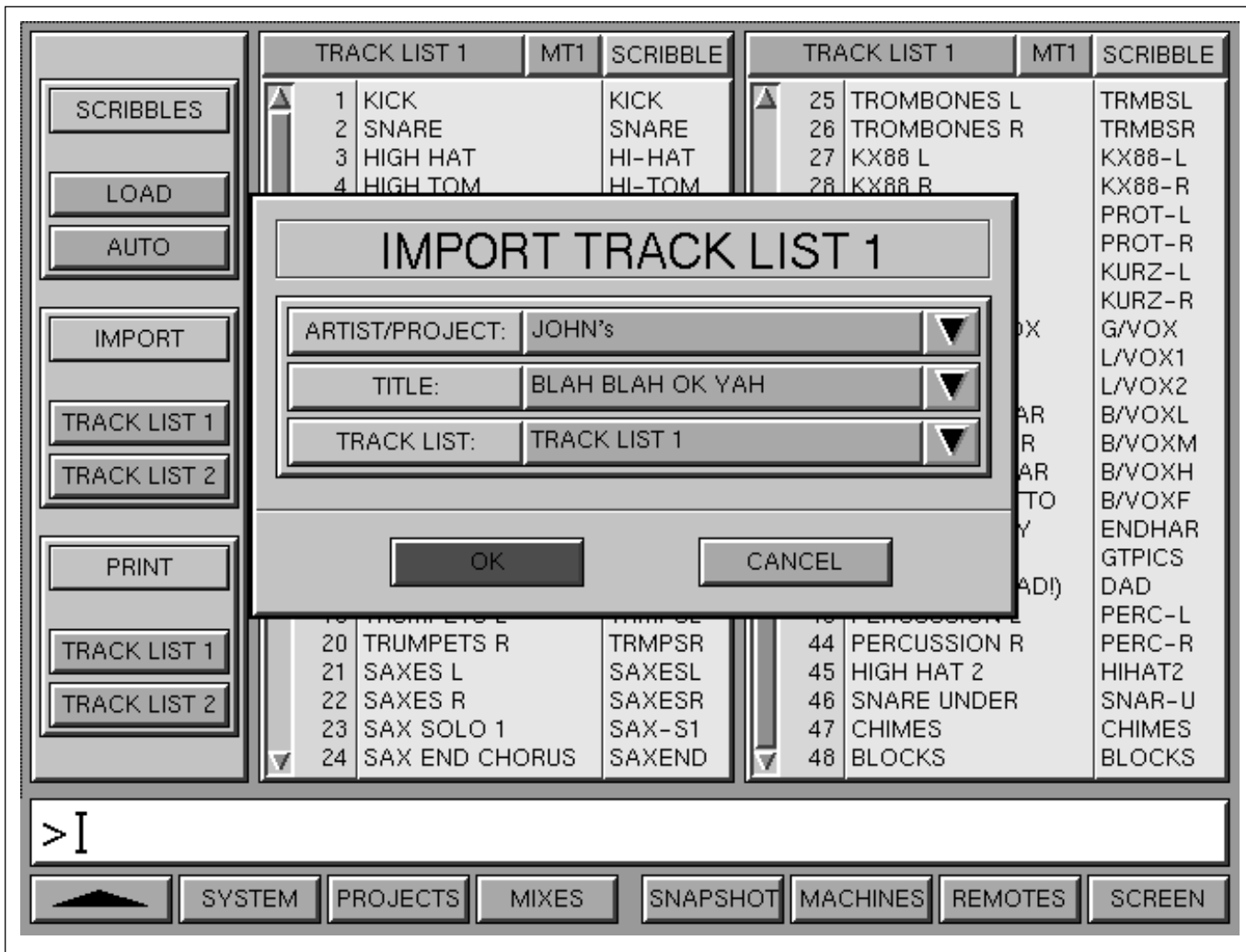

TRACK LISTS screen displaying the IMPORT TRACK LIST 1 pop-up

### To name Scribbles

To name or edit a Scribble entry, highlight it and use the same procedure as is used for naming Tracks. A maximum of 6 characters may be typed in.

### Load Scribbles

The Scribble entries can be propagated from Track List 1 and 2 to the Scribble entries in the I/O GUI pages according to the routing of MT1 and MT2.

Click on LOAD to propagate the Scribble names to the appropriate channel I/O M/T Scribble entries.

Click on AUTO to highlight so that channel I/O scribbles are 'on line'. In other words any edits to track lists are propagated immediately.

### Importing Track Lists

At the IMPORT block, click on TRACK LIST 1 or 2

for a pop-up. Click on the appropriate ▼ icons for pop-ups, or just click (and click) on the name banners to cycle through what is available. It is possible to view the full TITLES pop-up whilst clicking on the ARTIST/PROJECT BANNER. Having located the desired source Track List to be imported, click on OK or (ENTER) on the Control Keyboard.

### Printing Track Lists

At the PRINT block, click on TRACK LIST 1 or 2 respectively for the print pop-up. Make sure the correct printer destination is displayed and click on OK or (ENTER) on the Control Keyboard.

### Command Dialogue

At the base of the screen, the User Command Dialogue Line bar displays commands from the dedicated Control Keyboard and QWERTY Keyboard for confirmation before (ENTER).

## 7-6 The Session Management™ Screen Pages

---

### Menu options

Menu options available using the softkey functions displayed at the foot of the Track Lists screen page are as follows:

- ▲ - Selects the previous screen page.
- SYSTEM** - Selects the SYSTEM screen page directly.
- PROJECTS** - Selects the ARTISTS/PROJECTS & TITLES page.
- MIXES** - Selects the MIXES & CUES page.
- SNAPSHOT** - Selects the SNAPSHOTS, COPY & LINK page.
- MACHINES** - Selects the MACHINES set-up parameters page.
- REMOTES** - Selects the MACHINE REMOTES assignment matrix.
- SCREEN** - Selects pop-up showing all available screen selections. Click on any one to select it



## 7-6-8 Snapshots, Copy & Link Screen

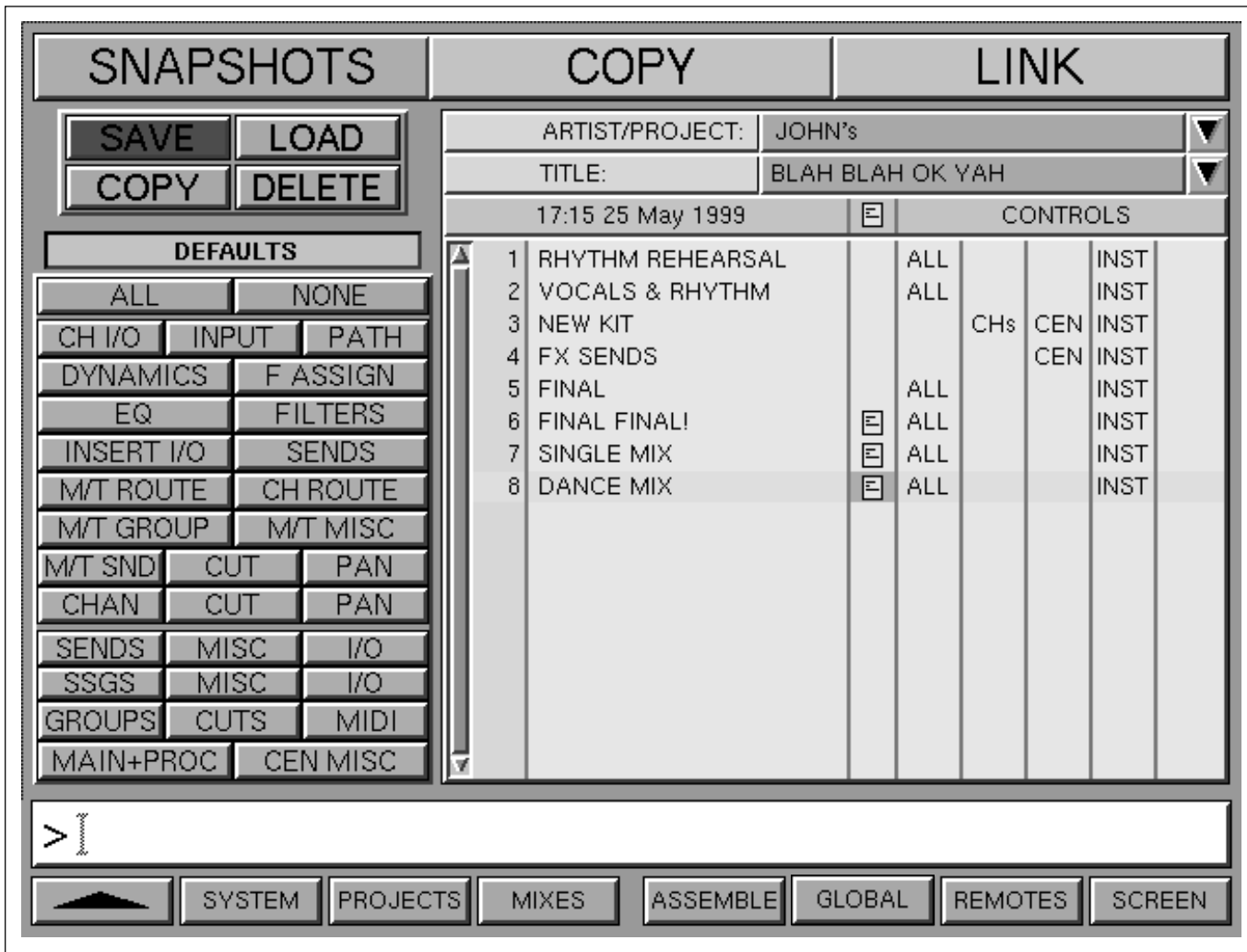

SNAPSHOTS, COPY & LINK GUI displaying the Snapshot DEFAULTS

### General

This screen has three pages allowing control of Snapshots, Copy and Link functions. Click on the heading bar for the page required.

Snapshots may be saved ranging from the full system down to a minimum of 1 channel. However, Snapshots may be loaded down to component sections of channels, depending on the Snapshots DEFAULTS selector. Snapshots for elements such as EQ and Dynamics may be loaded individually to their original channel or any number of other channels. For COPY and LINK, there are separate sets of defaults related to the copying and linking of settings from one channel to one or more others.

### DEFAULTS block

The availability of buttons in the DEFAULTS block layout will change depending on whether the current operation is SNAPSHOTS, COPY or LINK.

Click on the appropriate buttons to highlight in orange the channel sections required, such as EQ and Dynamics. Click on ALL to highlight the complete channel then de-select the sections not required or, if more convenient, click on NONE to de-select all sections and then click on the ones required.

## 7-6 The Session Management™ Screen Pages

### DEFAULTS selector definitions

As described, three separate selectors are available for SNAPSHOTS, COPY and LINK. The buttons are defined as:

#### CHANNEL Selector

<b>ALL</b>	• All Channel Controls and I/O
<b>CH I/O</b>	• Channel Input sources and Output destinations, with gain settings and electronic scribbles (not channel insert)
<b>INPUT</b>	• Mic, Line and M/T input selector and Phase switches
<b>PATH</b>	• 8 section Channel Path selector and IN buttons
<b>DYNAMICS</b>	• All Dynamics section controls
<b>F. ASSIGN</b>	• All Free Assign Area controls, currently Delay
<b>EQ</b>	• All Equaliser controls (not Filters)
<b>FILTERS</b>	• All Filter controls
<b>INSERT I/O</b>	• Analogue or digital I/O related to the Channel Insert
<b>SENDS</b>	• All Send levels, their Pans and Cuts
<b>M/T ROUTE</b>	• Multitrack Routing
<b>CH ROUTE</b>	• Channel Routing
<b>M/T GROUP</b>	• Multitrack Group Cut and Trim
<b>M/T MISC</b>	• Multitrack group monitor levels, Pans and Cuts
<b>M/T SND CUT PAN</b>	• Multitrack Send Fader • Multitrack Send Cut switch • Multitrack Send Pan setting
<b>CHAN CUT PAN</b>	• Channel Fader • Channel Cut switch • Channel Pan setting

### CENTRE SECTION Selector

The following buttons are for centre section settings and apply only to Snapshots:

<b>SENDS MISC I/O</b>	• Send levels and cuts • Send tone and stereo settings • Send I/O settings
<b>SSGS MISC I/O</b>	• Super Send Groups levels and cuts • Super Send Groups inserts • Super Send Groups I/O settings
<b>GROUPS CUTS</b>	• Control Group Faders • Control Group Cuts
<b>MIDI</b>	• MIDI Set-up Pages 1-24
<b>MAIN+PROC</b>	• Main Fader, I/O, Dynamics and EQ settings
<b>CEN MISC</b>	• Talkbacks, Foldbacks, Monitoring and Metering

### SNAPSHOTS

Snapshots can be saved and loaded by two basic methods: using dedicated keys on the Control Keyboard or clicking on buttons in the Snapshot GUI. The first method is the faster but is restricted to Snapshots of the whole system in the current title whilst the second allows full access to all Snapshot files with selective loading. Channels can be selected down to individual component sections and controls according to the SNAPSHOT DEFAULTS. A single channel can be used as a source for any number of destination channels.

#### Snapshot SAVE using the dedicated keys

The most convenient way to save a Snapshot is by using the dedicated keys on the Control Keyboard. This functions irrespective of the screen currently displayed. Using the dedicated keys to save a Snapshot always saves a full console-wide Snapshot.

Press **[SAVE]** **[SNAPSHOT]** **[ENTER]** to overwrite the currently highlighted Snapshot on the SNAPSHOTS page. A dialogue pop-up will appear in order to make the user aware of which Snapshot will be overwritten as well as allowing the command to be cancelled.

Press **SAVE** **SNAPSHOT** **AS NEW** **ENTER** to make a new Snapshot and a pop-up appears displaying a new default number which may be changed to a suitable name. With this command, the screen automatically switches to the SNAPSHOTS, COPY and LINK GUI. Select the **ENTER** key or click **OK** in the pop-up to save the Snapshot.

### To edit a Snapshot name

Highlight and click on the name or press **EDIT** on the Control Keyboard to display a pop-up dialogue box. Type in a name using the QWERTY keyboard and press **ENTER** or click on OK.

### To re-order a Snapshot entry

Click on its number in the left hand column for a pop-up. Overwrite the current number using the numeric pad on the Control Keyboard, and press **ENTER** or click on OK. The list will re-order itself.

#### Note:

In this case, although the pop-up has a **CANCEL** button, cancelling affects only the naming process and the new Snapshot is always saved.

### Snapshot LOAD using the dedicated keys

Press **LOAD** **SNAPSHOT** **ENTER** to load the currently highlighted Snapshot. Using the dedicated keys to load a Snapshot always loads the original complete.

### Snapshot DELETE using dedicated keys

Press **DELETE** **SNAPSHOT** **ENTER** to erase the currently highlighted Snapshot on the SNAPSHOTS page. A pop-up will appear, allowing the command to be confirmed or cancelled.

### Snapshot SAVE via the GUI

Click on **SAVE** in the Snapshots GUI for pop-ups with more comprehensive options which include:

- ALL** • Saves Snapshot of the complete system.
- CHs** • Saves a Snapshot of all the Channels or specified channels depending on what has been selected using the pop-up. A 'GENERIC' channel save can be specified, which is useful for specific instrument settings. It will be labelled CH0 in the Snapshots list.

- CEN** • Saves a Snapshot of the Centre Section.
- INST** • Saves a Snapshot of the Installation set-up (the INST set-up is always saved).

#### Note:

A combination of a number of CHs and CEN is possible.

Click on pop-ups in the GUI to select the items to be stored in the Snapshot. Further options include where the Snapshot is to be stored.

The columns under the CONTROLS banner indicate which sections have been saved for any particular Snapshot.

### Snapshot LOAD via the GUI

Click on **LOAD** in the GUI for the load sequence pop-up. The load options are similar to the save options:

- ALL** • Loads Snapshot of the complete system (provided the Snapshot to be loaded is from an 'ALL' save).
- CHs** • Loads a Snapshot of all the Channels or specified channels depending on what has been selected in the defaults pop-up.
- CEN** • Loads a Snapshot of the Centre Section.
- INST** • Loads a Snapshot of the Installation set-up.

If CHs is selected in the Snapshot LOAD, then a selective load of less than a whole channel is possible. The Snapshot will affect the channel controls depending on what is highlighted in the SNAPSHOT DEFAULTS field.

### Snapshot COPY via the GUI

For a copy operation, the source Snapshot will be the one highlighted in the SNAPSHOTS GUI. Click on **COPY** in the GUI for fully comprehensive pop-ups to select the destination for the Snapshot. The name of the Snapshot placed in the destination can be changed during the the COPY process.

### Snapshot DELETE via the GUI

Click on **DELETE** in the GUI for a pop-up which allows the currently highlighted Snapshot in the SNAPSHOTS page to be deleted. Click **OK** (**ENTER** on the Control Keyboard) or **CANCEL** to abort the operation.

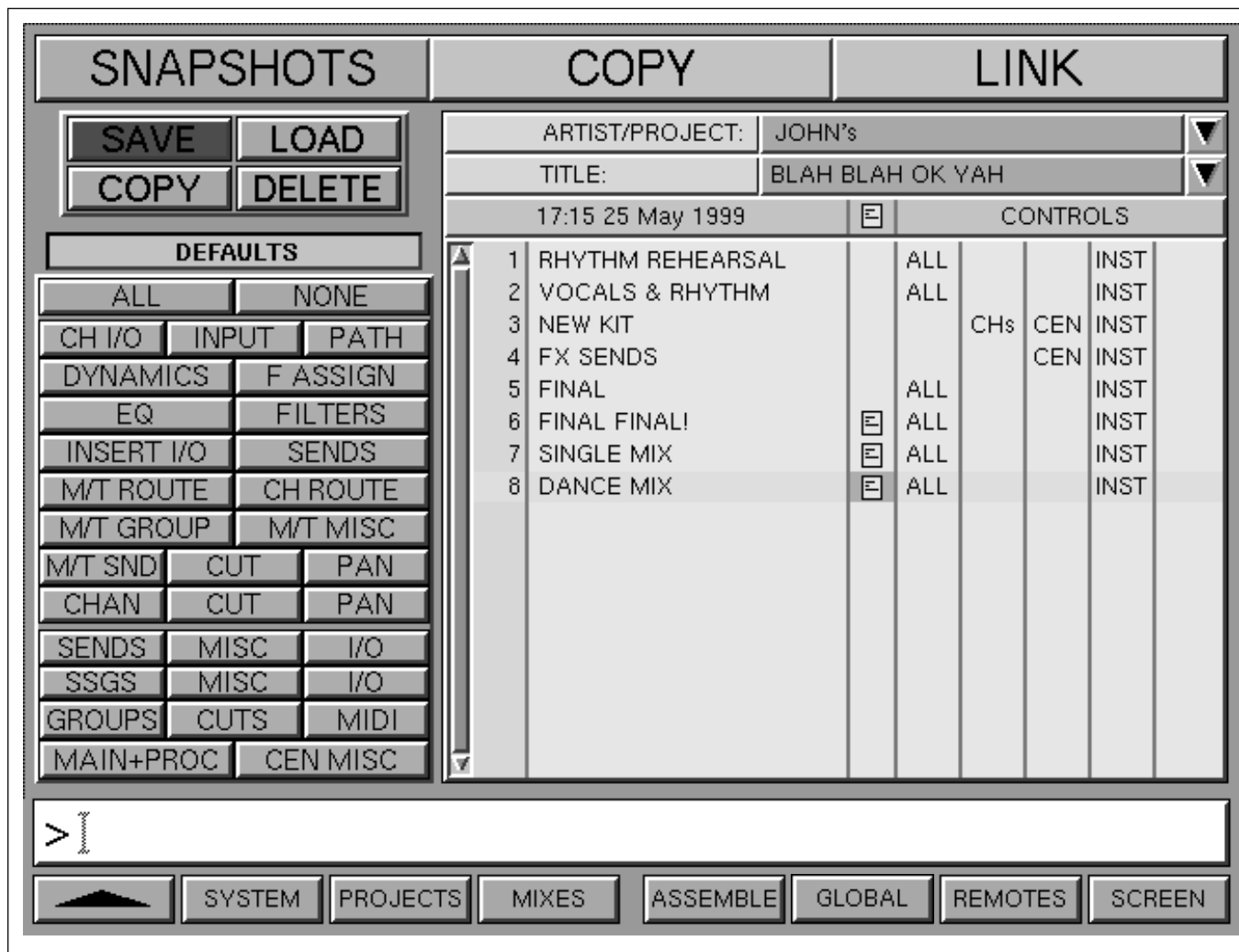

SNAPSHOTS, COPY & LINK GUI displaying the Snapshot DEFAULTS

### Main SNAPSHOTS list field

The majority of the screen area is taken up by the list of Snapshots. The functions are as follows:

### ARTIST/PROJECT

Click on ARTIST/PROJECT for a pop-up of options:

- **ARTIST/PROJECT**

Once selected, click on the banner to the right of ARTIST/PROJECT to cycle through Artist/Projects one by one. Alternatively, click on ▼ for a pop-up and highlight the desired Artist/Project.

**Note**

After clicking on ▼, it will reverse (▲) indicating that the pop-up will close if clicked on once more.

- **FACTORY LIB.**

Click on this option for a list of read-only FACTORY LIBRARY Snapshots supplied with the system.

- **STUDIO LIB.**

Click on this option to access STUDIO LIBRARY Snapshots designed for safe-keeping of studio-specific set-ups. This library has a password option.

- **USER LIB.**

Click on this option to access individual USER LIBRARIES. Click on the right side of the banner for a pop-up of Users. Click on the appropriate User name for the Snapshot list. A password option is available for USER LIB. entries.

**Note**

User names must be set up using the SYSTEM GUI.

## TITLE

Title is visible only when ARTIST/PROJECT is selected. Click on the banner to its right to cycle through Titles available for the current ARTIST/PROJECT one by one.

Alternatively, click on ▼ for a pop-up and highlight the desired Title.

### Note

After clicking on ▼, it will reverse (▲) indicating that the pop-up will close if clicked on once more.

It is sometimes useful to leave open the pop-up displaying Titles, allowing all Titles to be displayed for each Artist/Project as they are cycled through. Click on the banner to the right of the ARTIST/PROJECT banner to cycle through Artist/Projects one by one.

## SNAPSHOTS list

The Snapshot names are listed against the column of numbers to their left. The list can be stepped through using the ↑ and ↓ on the Control Keyboard or scrolled through using the scroll bar to the left of the numbers column.

## NOTES column

The column to the right of the names allows individual Notes to be made for each Snapshot. Click in this column or highlight and press **EDIT** level with the appropriate name for its notes pop-up. Type in the notes and click on **OK** or press **ENTER** on the Control Keyboard. An icon will then be displayed in the NOTES column against the snapshot.

## CONTROLS Column

These columns indicate what any particular Snapshot consists of:

- ALL** • ALL is displayed if a Snapshot of the complete system has been stored.
- CHs** • CHs is displayed if all or some channels have been stored as a Snapshot.
- CH0** • CH0 indicates that a single generic channel has been stored. It has no relation to any previous channel snapshots, hence CH0. This is useful as a setting for a particular instrument type, for example.

- CEN** • CEN is displayed to indicate that a Snapshot includes the Centre Section settings.

- INST** • Will always be displayed indicating that the installation set-up has been stored.

## Command Dialogue

At the base of the screen, the User Command Dialogue Line bar displays commands from the dedicated Control Keyboard and QWERTY Keyboard for confirmation before **ENTER**.

## Menu options

Menu options available using the softkey functions displayed at the foot of the Snapshots, Copy & Link screen page are as follows:

- ▲ - Selects the previous screen page.
- SYSTEM** - Selects the SYSTEM screen page directly.
- PROJECTS** - Selects the ARTISTS/PROJECTS & TITLES page.
- MIXES** - Selects the MIXES & CUES page.
- ASSEMBLE** - Selects the mix compilation MERGE/ASSEMBLE page.
- BACKUPS** - Selects system BACKUPS functions.
- REMOTES** - Selects the MACHINE REMOTES assignment matrix.
- SCREEN** - Selects pop-up showing all available screen selections. Click on any one to select it.

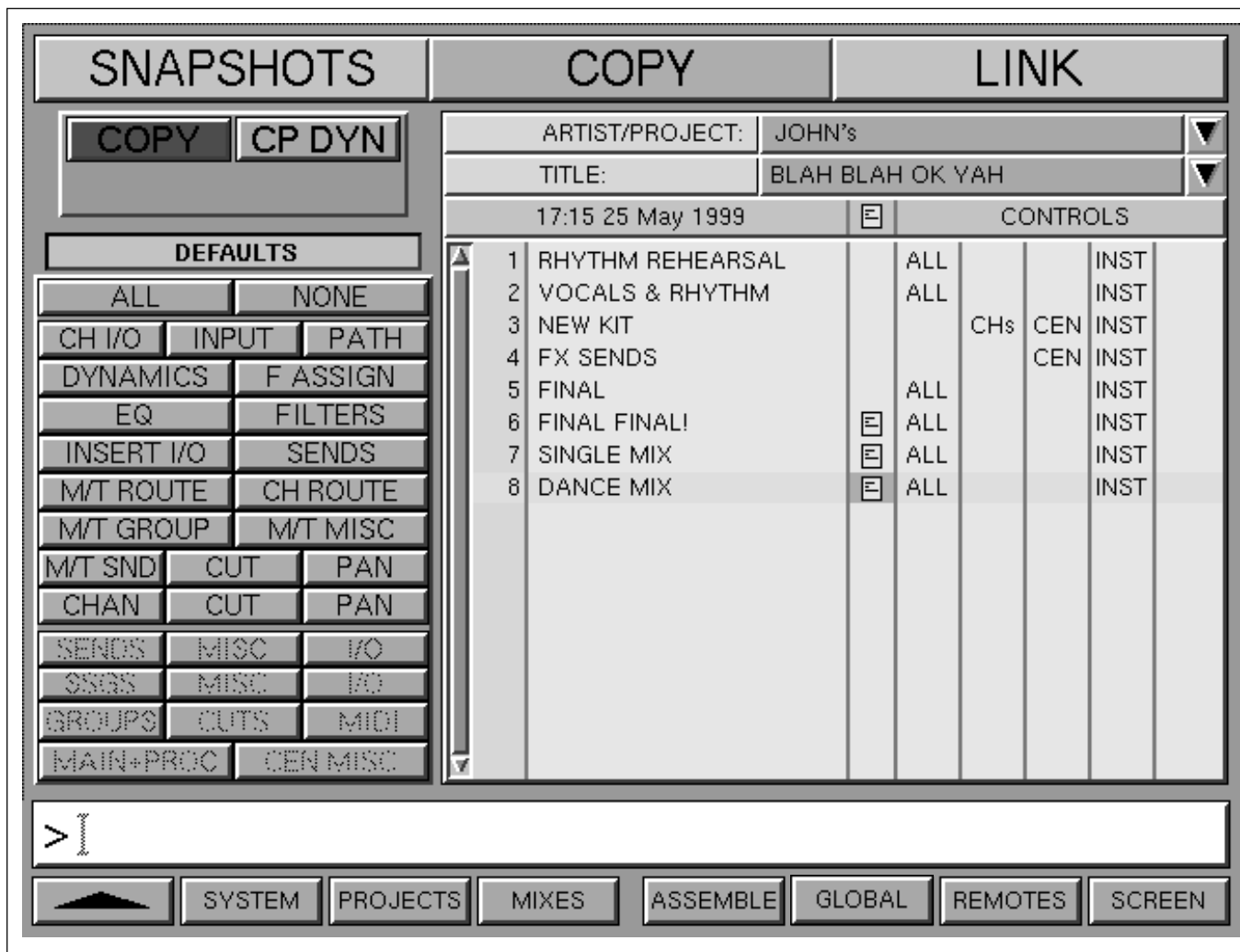

SNAPSHOTS, COPY & LINK GUI displaying the Copy DEFAULTS

## COPY and LINK in general

Copy and Link functions can be performed either locally in the channels sections, known as ‘Quick Copy’ and ‘Quick Link’, or via GUI control.

Using the ‘Quick’ method, Copy and Link may be combined into a single operation that allows Copy and Link simultaneously. Since Copy and Link functions can be performed together they will both be described in this section.

## QUICK COPY

Channels may be copied without using the GUI. This is accomplished using the **upper row** of **ACCESS** buttons, as follows:

- **Push and hold down the upper ACCESS button for the source channel.**

- **Its ACCESS will light, first red and then turn amber after half a second.**
- **When it has changed to amber, select the upper ACCESS buttons for the destination channels, one by one.**

This method is often quicker than using the GUI, particularly for small numbers of channels.

The control settings copied in ‘Quick Copy’ are set according to what is highlighted in the Copy DEFAULTS panel displayed on the COPY page. Click on COPY in the banner at the top of the GUI to see the Copy DEFAULTS.

### Note

Quick Copy will copy static settings only. Automation data must be copied using GUI operations.

## QUICK LINK

This is accomplished using the **lower row** of **ACCESS** buttons, as follows:

- Press and hold down the lower **ACCESS** button for the source channel.
- Its **ACCESS** will light, first red and then turn amber after half a second.
- When it has changed to amber, select the lower **ACCESS** buttons for the destination channels, one by one.

In this case, controls are linked and any offsets between knob settings are retained.

### Note

*The retention of offsets applies only to those knobs which can be fully automated.*

The control settings linked in ‘Quick Link’ are set according to what is highlighted in the Link DEFAULTS field displayed on the LINK page. Click on LINK in the banner at the top of the GUI to view the LINK DEFAULTS.

### Note

*Make sure LINK DEFAULTS is highlighted in red in the LINK page. Click on it if not.*

## QUICK COPY and LINK

This is accomplished using the **upper and lower rows** of **ACCESS** buttons, as follows:

- Press and hold down the lower **ACCESS** button for the source channel.
- Its **ACCESS** will light, first red and then turn amber after half a second.
- When it has changed to amber, select the upper **ACCESS** buttons for the destination channels, one by one.

The control settings linked in ‘Quick Copy and Link’ are set according to what is highlighted in the Link DEFAULTS field displayed on the LINK page. Click on LINK in the banner at the top of the GUI to view the LINK DEFAULTS.

### Note

*Make sure LINK DEFAULTS is highlighted in red in the LINK page. Click on it if not.*

## 7-6 The Session Management™ Screen Pages

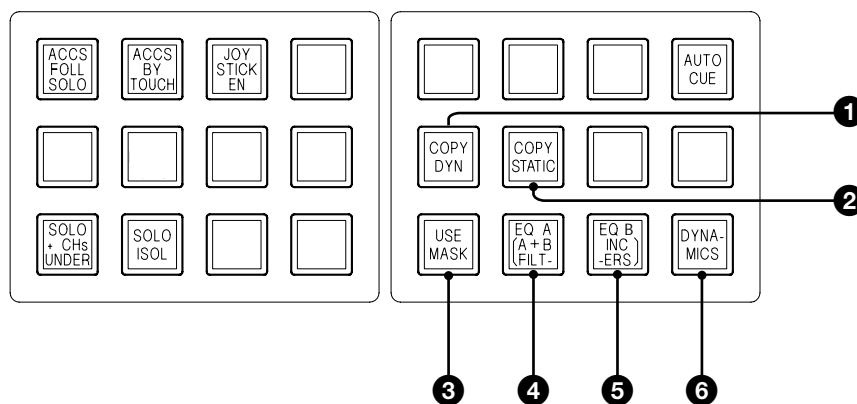
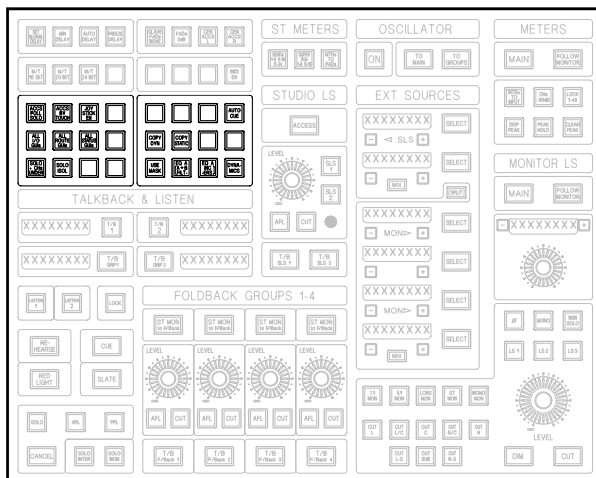

Section of the Monitor panel indicating the buttons related to QUICK COPY

### ❶ COPY DYN Push-Button

This is a latching function and applies to all ‘COPY’ and ‘QUICK COPY’ functions that are performed using button push operations. If **COPY DYN** is selected, any copy operations will include dynamic automation data. **COPY DYN** inter-cancels with **COPY STATIC** ❷, or it can be turned on and off, when it returns to defaults.

### ❷ COPY STATIC Push-Button

This is a latching function and applies to all ‘COPY’ and ‘QUICK COPY’ functions that are performed using button push operations. If **COPY STATIC** is selected, any copy operations will be limited to static settings only. **COPY STATIC** inter-cancels with **COPY DYN** ❶, or it can be turned on and off, when it returns to defaults according to the COPY GUI.

### ❸ USE MASK Push-Button

Sets Copy and Link operations according to the DEFAULTS in the SNAPSHOTS, COPY & LINK GUI.

### ❹ EQ A Push-Button

Limits Copy and Link functions to Equaliser A settings.

### ❺ EQ B Push-Button

Limits Copy and Link functions to Equaliser B settings.

### ❻ DYNAMICS Push-Button

Limits Copy and Link functions to Dynamics section settings.



**Note**

**USE MASK** inter-cancels with **EQ A** or **EQ B** or **DYNAMICS**. But **EQ A**, **EQ B** and **DYNAMICS** can be used in any combination. If **EQ A** and **EQ B** are on simultaneously, the Filters are also included in Copy and Link operations.

**Adjusting offsets with Faders and Knobs**

The offsets between linked control functions can be adjusted in a number of ways.

**• Faders**

To adjust offsets between faders, touch and hold one and adjust any others in the Link Group.

**• Definable Knobs** (such as Pans)

To adjust offsets between definable knobs, press and hold one knob and adjust any others in the Link Group.

**• Other Knobs** (e.g. EQ or Dynamics sections)

To adjust knobs in the assignable channels section areas, de-select the channel from the Link Group, make the adjustments and then re-link that channel into the Link Group.

It is possible, with EQ panels for example, to press and hold a knob on one side of the control surface and adjust the same knob on a linked channel the other side.

**COPY using the GUI**

The COPY and CP DYN buttons in the GUI allow the copying of channel functions using two GUI pop-ups.

The definitions for COPY and CP DYN are:

- COPY** • Copies the static settings of controls.
- CP DYN** • Copies the Dynamic Automation data for automated controls and static settings for others.

All Copy functions will affect channel controls according to the Copy DEFAULTS fields.

Click on COPY for pop-ups in the following order:

**SELECT SOURCE CHANNEL pop-up**

Click on the required source channel to highlight a source. As soon as one is highlighted the destinations pop-up will appear.

**DESTINATIONS FOR SOURCE CHANNEL**

Click on DESTINATION CHANNELS to highlight them or click on the screen menu buttons:

- ALL** • To send copy data to all channels.
- RANGE** • Highlight the first and last channel of a range.

It is possible to mix these function i.e. click on ALL and un-highlight a number of channels, for example.

Click OK, and the SELECT SOURCE CHANNEL pop-up appears ready to select another source channel and more destinations, or click OK to finish the operation.

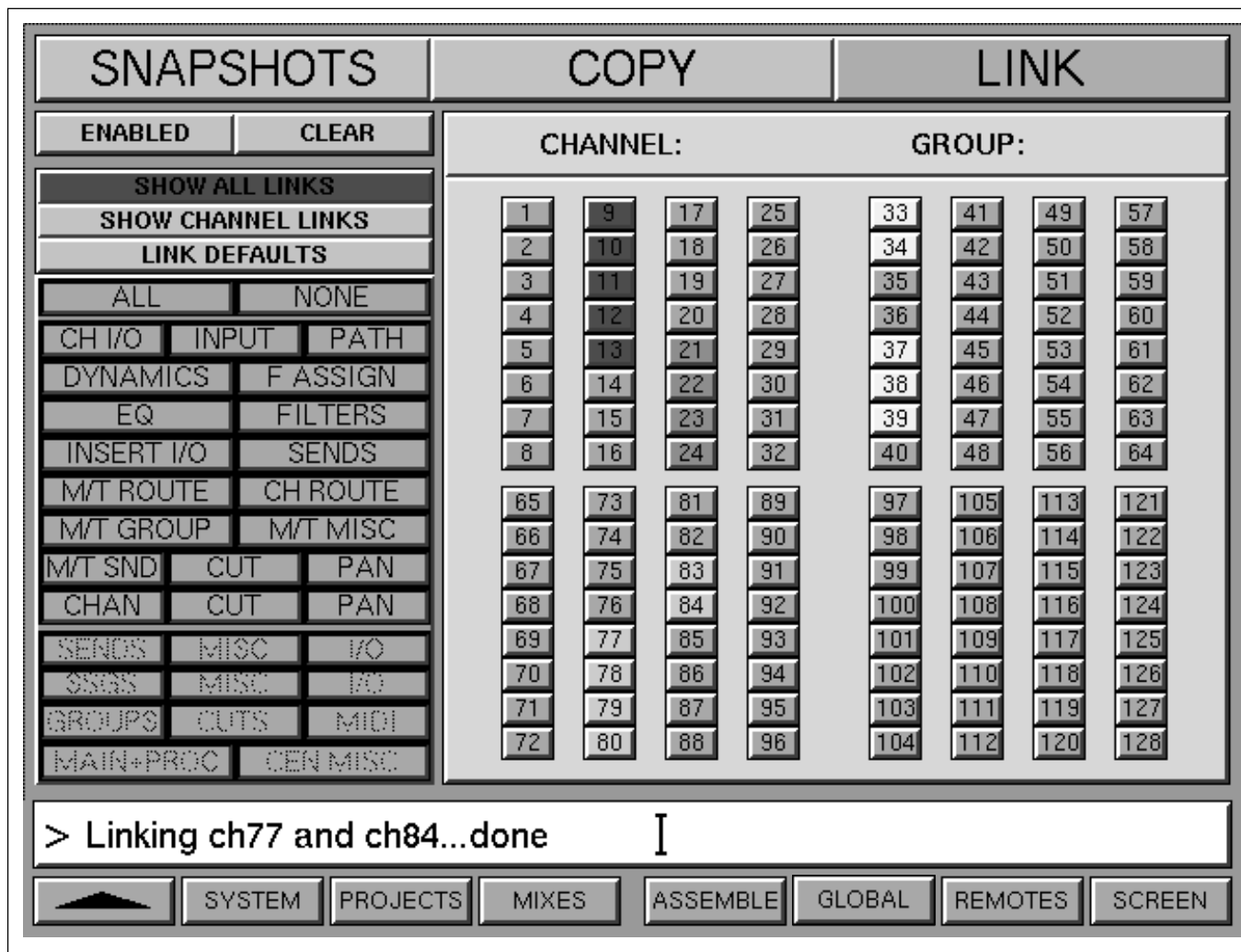

SNAPSHOTS, COPY & LINK GUI displaying SHOW ALL LINKS

### LINK GUI in general

Click on LINK in the banner at the top of the screen to display the Link Groups set-up and display fields. This page aids the set-up of Link Groups, each of which can have different control selections. All Link Groups can be viewed simultaneously with the aid of colour coding for each group.

### LINKS DEFAULTS

Click on the title banner above the channel defaults, as shown in the GUI illustration above, to view the LINK DEFAULTS. Any channel linking operations will link the controls according to what is highlighted in orange in this field. Click on the options to adjust what will be linked. To link some channels:

### QUICK LINK

This is accomplished using the **lower row** of ACCESS buttons, as follows:

- **Press and hold down the lower ACCESS button for the source channel.**
- **Its ACCESS will light, first red and then turn amber after half a second.**
- **When it has changed to amber, select the lower ACCESS buttons for the destination channels, one by one.**

In this case, controls are linked and any offsets between knob settings are retained.

---

## SHOW ALL LINKS

Click on SHOW ALL LINKS to display all the current Link Groups simultaneously. Each group has its own colour code.

## SHOW CHANNEL LINKS

When the ACCESS on a channel in a Link Group is pressed and held until it changes colour to amber, the GUI switches automatically to indicate the channels in the group and highlight the sections linked. The SHOW CHANNEL LINKS banner highlights red to confirm what is being displayed. The indications in the channel numbers area are as follows:

### Heading banner

- CHANNEL:** • the channel number accessed.  
**GROUP:** • the Group number.

The groups are numbered consecutively as they are created. If a group is disbanded then the number will be re-used later when another group is created.

### Highlights in channel numbers panel:

- Orange** • the channel accessed.  
**Red** • the other members of the group.

## ENABLED (LOCKED) button

Clicking on this button (immediately below the SNAPSHOT legend) changes it to LOCKED, which inhibits accidental linking changes by locking the existing Link Groups.

## CLEAR button

Clicking on this button (to the right of the ENABLED button), allows all links to be cleared. A dialogue pop-up requires confirmation.

## 7-6 The Session Management™ Screen Pages

### 7-6-9 Copy Channel Fader Balance to M/T Faders and M/T to Channels

#### General

This function allows the copying of the Main Output Bus balance (serves as monitor bus), set by the Channel Faders, to the M/T Send Faders balance and vice versa. This will also include Surround Pan settings.

#### Copy Channel Faders to M/T Send Faders

On the Select To Faders panel, press and hold **[CHANS]** until it turns amber. Then press the **[M/T SEND]** button.

#### Note

**[M/T SEND]** remains selected.

#### Copy M/T Send Faders to Channels

On the Select To Faders panel, press and hold **[M/T SEND]** until it turns amber. Then press the **[CHANS]** button.

#### Note

**[CHANS]** remains selected.

### 7-6-10 Copy Monitor and M/T Send Fader Balance to Cues

#### General

This function allows the copying of the Main Output Bus balance (serves as monitor bus) and the M/T Send Fader balance to any of the Send busses. This copy can be carried out for one bank of 24 channels at a time or all channels simultaneously.

#### Copy Monitor mix from ALL CHANNELS

On the Select To Faders panel, press and hold **[CHANS]** until it turns amber. Then press the desired **[SEND #]** button on the same panel. Release **[CHANS]**.

#### Note

The destination **[SEND #]** remains assigned to the faders after such an operation.

#### Copy Monitor mix from ALL M/T SENDS

On the Select To Faders panel, press and hold **[M/T SEND]** until it turns amber. Then press the desired **[SEND #]** button on the same panel. Release **[M/T SEND]**.

#### Note

There are 120 CHAN faders and 72 M/T SEND faders in the largest configuration.

#### Copy mix from a bank of 24 CHANNELS

On the Select To Faders panel, make sure **[CHANS]** is selected then press and hold the source bank button, **[CHS 1-24]** for example, until it turns amber. Then press the desired **[SEND #]** button on the same panel. Release **[SEND #]**.

#### Copy mix from a bank of 24 M/T SENDS

On the Select To Faders panel, make sure **[M/T SENDS]** is selected then press and hold the source bank button, **[CHS 1-24]** for example, until it turns amber. Then press the desired **[SEND #]** button on the same panel. Release **[SEND #]**.

### 7-6-11 Quick Copy EQ A to B and B to A

On the EQUALISER & FILTERS panel, press and hold **[A]** until it turns amber, then press **[B]**. Reverse this procedure to copy **[B]** to **[A]**.

All knob and switch settings get copied along with the Equaliser Type. Default settings copy automation data too. This may be set in the 'config set-up' to copy static settings only.

## 7-6-12 Machine Remotes Screen

MACHINE REMOTES						
MACHINES	REMOTE	STATUS	ABSOLUTE TIMECODE	SYNC	OFFSET	SUB FRAME
1 PCM-3324	2 SAFE	MASTER	00:00:00:00	00:00:00:00	00:00:00:00	0
2 Perfect	1 SAFE	INDEP.	00:02:12:08	00:00:00:00	00:00:00:00 PARKED	0
4 PCM-3348	3 SAFE	INDEP.	00:00:00:00	00:00:00:00	00:00:00:00	0
3 PCM-9000	4 SAFE	INDEP.	00:00:00:00	00:00:00:00	00:00:00:00	0
		MASTER	00:00:00:00	00:00:00:00	00:00:00:00	0
		SLAVE	00:00:00:00	00:00:00:00	00:00:00:00	0
		INDEP.	00:00:00:00	00:00:00:00	00:00:00:00	0
			00:00:00:00	00:00:00:00	00:00:00:00	0
			00:00:00:00	00:00:00:00	00:00:00:00	0

>I

SYSTEM PROJECTS MIXES SNAPSHOT COMMIT MACHINES SCREEN

MACHINE REMOTES screen page

### General

This GUI allows machines available in the system to be assigned to any one of the Machine Remote sets on the panel beneath the Control Keyboard. It allows selection of machines as Timecode Master, Slaves or Independent and displays the status of machines in general.

#### Note

As soon as any selections are made in this screen, the **COMMIT** softkey will change colour to orange. Any changes will not be actioned until the **COMMIT** softkey is pressed.

### MACHINES column

Click on the machine name or # for a pop-up of the machines available in the system set-up.

### REMOTE column

Click on the square button below the REMOTE heading for a pop-up to select one of the Machine Remote sets 1-4 depending on where the machine is required to be controlled from.

Click the SAFE/REC flag to toggle between 'Machine Record Status Safe' and 'Armed'.

## 7-6 The Session Management™ Screen Pages

### STATUS column

This uses a pop-up to allow the selection of the status of machines as follows:

#### • MASTER

Selects a machine as the Timecode Master. There can be only one Timecode Master so selecting MASTER (and the COMMIT) will take the Timecode Master status away from any other machine.

#### • SLAVE

Selects a machine as a Slave to the Timecode Master machine. The remotes for this machine will follow whatever the Master does but will not be operative themselves.

#### • INDEP

Selects a machine to be Independent and fully operative.

### ABSOLUTE TIMECODE

The ABSOLUTE TIMECODE display indicates the timecode for its machine.

### SYNC column

If belonging to a Slave, the Timecode Display shows 00:00:00:00 when locked, or the difference between itself and the Master whilst becoming synchronised. If the system is unable to synchronise this machine with the Master, the timecode difference will be displayed.

The Sync Flag, situated below the sync timecode readout for each machine, displays the SYNC status i.e. LOCKED, UNLOCKED.

### OFFSET column

Click on the Timecode Display for a pop-up to allow OFFSET adjustment.

### Using the Numeric Key-pad to Enter Timecode

The entry format is exactly the same as that used for PCM-3324/48 series remote control units:

1	=	00:00:01:- -
12	=	00:00:12:- -
1234	=	00:12:34:- -
12345	=	01:23:45:- -
123456	=	12:34:56:- -
12345621	=	12:34:56:21
12:34:56:21	=	12:34:56:21
12:34:56	=	12:34:56:- -

### Timecode shortforms:

:: Separates hours/minutes  
: Separates minutes/seconds  
. Separates seconds/frame

12::	=	12:00:00:00	Specifies hours
34:	=	00:34:00:00	Specifies minutes
56	=	00:00:56:00	Specifies seconds
.21	=	00:00:00:21	Specifies frames

The Motion Status Flag, situated below the timecode offset readouts, displays the motion status: PARKED, PLAYING, WINDING, REWINDING etc.

### SUBFRAME column

Click on for a pop-up to type in a Subframe offset between 0 and 99 which can be negative or positive. Prefix with '-' for a negative number.

---

## Command Dialogue

At the base of the screen, the User Command Dialogue Line bar displays commands from the dedicated Control Keyboard and QWERTY Keyboard for confirmation before **ENTER**.

## Menu options

Menu options available using the softkey functions displayed at the foot of the Machine Remotes screen page are as follows:

- ▲** - Selects the previous screen page.
- SYSTEM** - Selects the SYSTEM screen page directly.
- PROJECTS** - Selects the ARTISTS/PROJECTS & TITLES page.
- MIXES** - Selects the MIXES & CUES page.
- SNAPSHOT** - Selects the SNAPSHOTS, COPY & LINK page.
- COMMIT** - Lights up orange when changes made on screen. Press this softkey to implement changes. Reverts to its normal (blue) colour.
- MACHINES** - Selects the MACHINES set-up parameters page.
- SCREEN** - Selects pop-up showing all available screens selections. Click on any one to select it.

# 7-7 Dynamic Automation Moves

## 7-7-1 Motorised Fader Controls

### 1 Touch-sensitive fader knob

When dynamically automated moves are replaying, touching the fader knob inhibits the electronic servo control. Control of the audio level depends on the system mode at the time.

### 2 Automation Write button

The small tactile button in the fader knob allows single finger operation when dropping in to write moves in absolute or trim. Whilst the fader is moving, take control of the fader with one finger and - at the appropriate time - press the Write button with the same finger.

#### Note

The Ready **ABS** or **TRM** button must be selected to record moves, indicated by their LEDs flashing.

### 3 Yellow Touch LED

This LED lights when the system detects that a finger is touching the fader.

### 4 Ready ABS (Absolute) Write button

Pressing the **ABS** button puts the fader into the 'ready absolute' status. If the Automation Write button in the fader knob is then pressed, automation data will be written.

### 5 Red Absolute LED

This LED indicates the Absolute write record status of the fader. Flashing indicates a record ready status and fully lit means that move data is being recorded.

### 6 Ready TRM (Trim) button

Pressing the **TRM** button puts the fader into the 'ready trim' status. The **TRM** and **ABS** buttons inter-cancel.

### 7 Green Trim LED

This LED indicates the Trim write record status of the fader. Flashing indicates a record ready state and fully lit means that any trimming move data will be recorded.

### 8 Bi-colour fader CUT switch

This switch illuminates red when the cut is implemented manually, and amber if the cut is controlled by the automation system. It is lit extra bright and amber if manual and automated cuts are performed simultaneously.

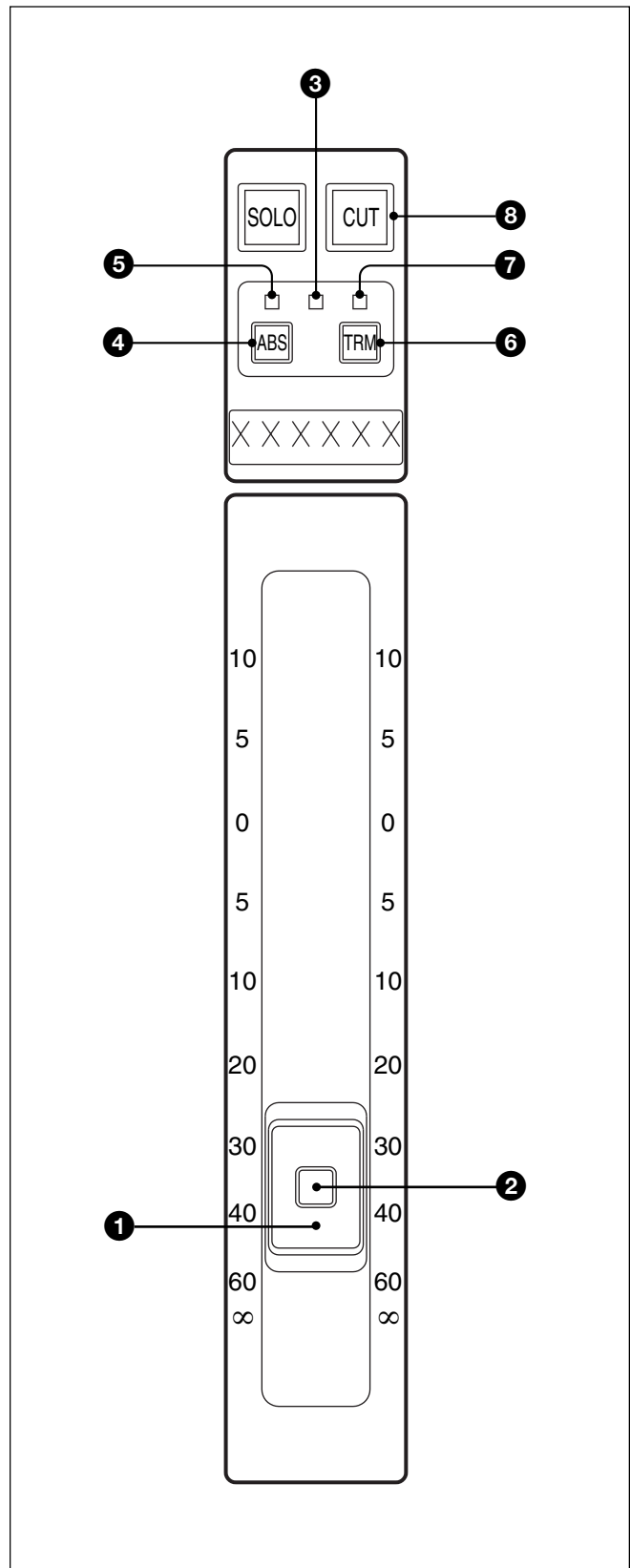

Motorised Fader controls



## 7-7-2 Automating Faders

### To automate moves on one Fader

There are two ways to set data to be written for fader moves, either by using the tactile button in the middle of the fader knob or in Touch Write mode, where just touching the fader puts it into record. A write ready state must be selected in both cases.

The first time that moves are recorded for a fader (or any other object), the system assumes automation data from the start to the finish of the title for that fader. If the moves are over less than the full duration of the Title, then the exact position prior to moves is assumed to the beginning of the Title. The same fader level will also be applied after the last recorded fader move to the end of the Title. From then on, the fader will snap back for the duration of the whole Title. To take the setting after the last move to the end of the Title, select **TO END** under the central LCD.

- 1** Select ready **ABS**. The red **ABS**olute write LED flashes.
- 2** Press automation write in the fader knob. The red LED lights solidly indicating that any moves will be recorded. Press the Write button either before or after the tape is rolling. Pressing the button once more drops the fader back to 'ready absolute' indicated by the LED flashing again. Pressing **ABS** will also drop out of record returning the fader to 'safe'.
- 3** For Touch Write, latch **TOUCH WRITE** beneath the central LCD. Select ready **ABS** so that the red 'ready' LED flashes. Then, every time a fader knob is touched, it will drop in to writing move data. This will be indicated by the red LED lighting solidly for the touch period. As soon as finger contact is released, the LED will flash again. To keep the fader in record, just press **ABS** whilst it is being touched. Then when the finger is removed, the red LED will still be fully on, indicating data is still being written. But remember that if the fader is touched again, it will drop out of record when released, unless **ABS** is **pressed and held** whilst removing the finger.

#### Note

The write button in the fader knob is operable in Touch Write mode.

- 4** To revise any moves, roll back using the transport keys and play again. As soon as the tape is rewinding, the red LED will flash indicating the ready state. Put the tape into play and previous moves will be heard and will be displayed by the motorised fader. In Touch Write, touching the fader will overwrite previous moves and the audio will follow fader moves accordingly.

Otherwise (if Touch Write is not selected) even if the fader is touched, the previous moves will still be heard up to the moment the Write button is pressed. From then, absolute fader positions and moves will be recorded as well as heard. It is possible to roll back and stop the tape to go into Write mode before playing the tape again, if that is more convenient.

### To Trim moves for one Fader

- 1** Press the (ready) **TRM** button on the selected fader. The green trim LED flashes.
- 2** Pressing the automation write in the fader knob will set the null about which trimming moves are based. This can be done before starting the tape or after it is rolling. In Touch Write, the point at which the knob is touched sets the null point.

If Touch Write is not selected, before pressing the write button to set the null point, move the fader to a suitable part of its scale with good resolution. The '0' dB point is often a good setting.

#### Note

- 1 It is useful to have **SHOW VALUE** selected on the Select to Faders panel so that fader dB values will indicate the trimmed difference compared to the source mix.*
- 2 An **AUDITION** function, described later in this chapter, allows dropping-in at a preset auditioned level point.*

If the tape is rolled before write is pressed, the previous moves will be heard and displayed. Even if the fader is touched, the moves will still be heard.



An indication in dBs shows how far the fader has to be moved and the moves are also reflected in the balance. As the fader is moved, it drops back to ready when it matches the original level.

In Touch Write, just releasing the finger for an instant indicates to the system that the user wants to drop out of recording moves. Then the scribble display indicates direction and level difference as described above.

- ⑤ **TO END** - Where the fader position at the drop-out point is recorded to the end of the Title.

One drop-out mode is allowed at a time, so these four buttons inter-cancel. Different modes can be used on different faders by working in one mode first, and then rolling back to use another mode on different faders. Different modes can also be used on the same fader at different times. When finished writing moves, de-select ready absolute (press **ABS** or **TRM** again) to make the fader completely 'safe'.

### ⑥ **TO TOP Push-Button**

To Top is a related function allowing fader position to be recorded from any point within the Title to the beginning, for both absolute and trim modes.

If a fader is in record then it is the point at which **TO TOP** is pressed which determines the absolute level or trim offset. If **TO TOP** is already on then it is the point at which the fader is dropped into record.

#### **Note:**

A Preferences set-up option allows the level point to be determined at the automation drop-out point. **TO TOP** must be latched to work in this mode. See section 7-11 later in this chapter.

## Global, Touch and Audition functions

See illustration 'Global, Touch and Audition keys'.

### ① **GLOBAL DROP-IN Key**

Causes all controls in automation 'ready' status, both **ABS** and **TRM**, to drop in to automation write.

### ② **GLOBAL DROP-OUT Key**

Causes all controls in write to drop out of automation record returning to automation 'ready' status.

#### **Note:**

'Film Mode' allows the system to be set up so that **GLOBAL DROP-IN** and **GLOBAL DROP-OUT** are operational on all controls except Faders, Cuts and Pans (see section 7-7-9).

### ③ **READY CANCEL Push-Button**

Causes all controls in automation 'ready' status, both **ABS** and **TRM**, to drop out of 'ready' back to 'safe'.

#### **Note:**

Any controls in write mode will not be affected.

## To record absolute moves for a number of faders

- 1 Select ready **ABS** on the faders and their red LEDs flash. They can be selected individually or in banks of 24. For a bank of 24 faders, on the Select to Faders panel, press and hold the bank button, **CHS 1-24** for example, until it turns amber and then press an **ABS** button on one of the faders. The **ABS** LEDs for the whole bank of 24 then flash indicating ready **ABS** status.
- 2 The faders can be dropped into write individually using their fader Write buttons or by touch in Touch Write mode. To drop them all into write simultaneously, use the **GLOBAL DROP-IN** key on the Control Keyboard. This works in Touch Write mode as well. But remember that if a fader is touched, it will drop out of write when released. Press the **ABS** button before letting go to continue to have data recorded.

To revise moves, roll back and play again, then press **GLOBAL DROP-IN** at the right time. As for all write functions, the user can rewind and stop the tape before going into write mode.

## 7-7 Dynamic Automation Moves

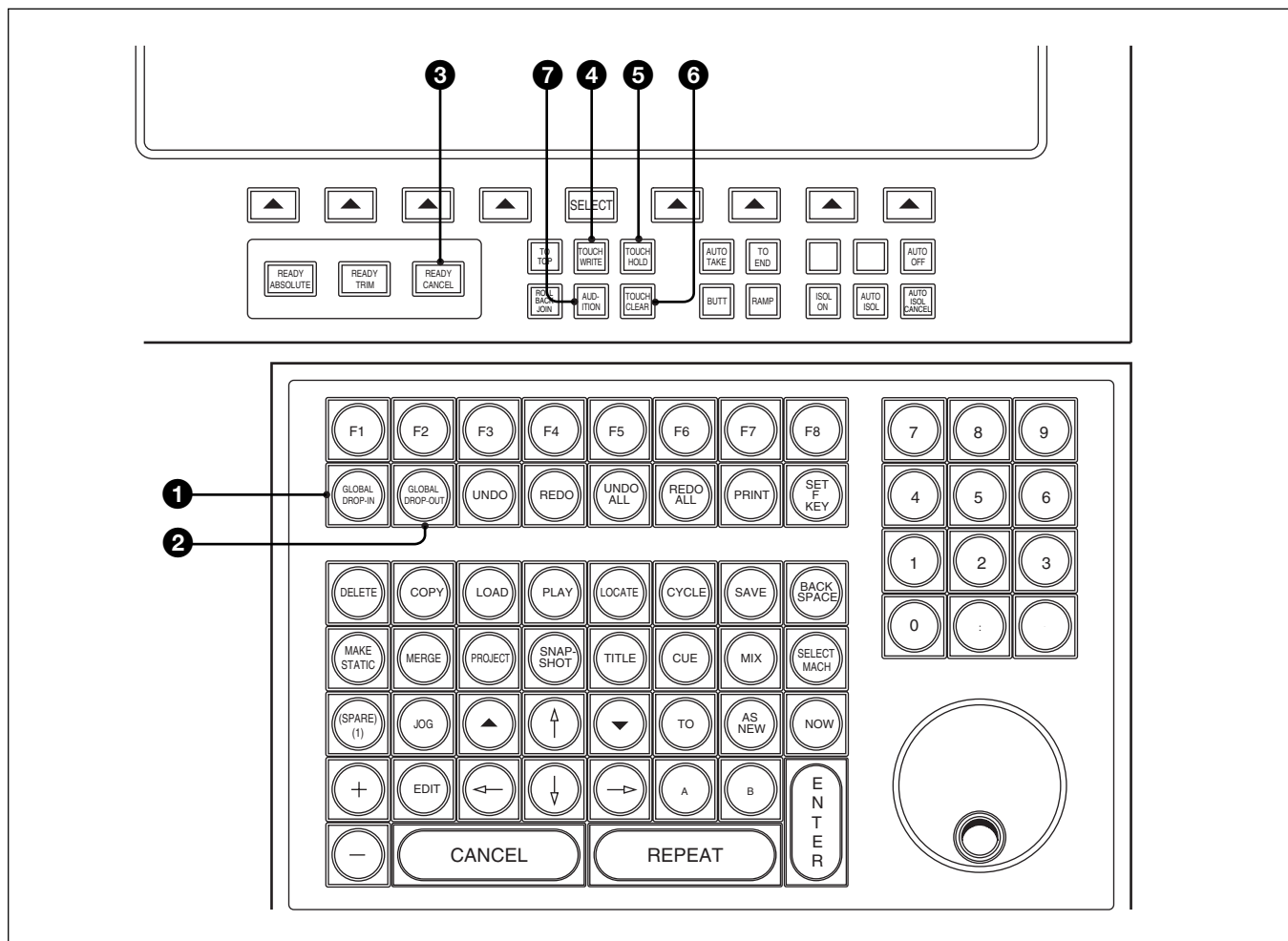

Global, Touch and Audition keys

To take all faders out of write mode, press **[GLOBAL DROP-OUT]** on the Control Keyboard and then **[READY CANCEL]**, below the central LCD, to make the faders completely 'safe'.

### To trim moves for a number of faders

To trim moves for a number of faders, put the desired faders into ready **TRM** individually or in banks of 24 as described above for recording absolute moves

Use local Write buttons in fader knobs or **[GLOBAL DROP-IN]** and **[GLOBAL DROP-OUT]** on the Control Keyboard to action the recording of moves in just the same way as for absolute moves.

### Fader TOUCH modes

#### 4 TOUCH WRITE Push-Button

This button latches, allowing any faders set in ready

**ABS** or ready **TRM** to have their moves recorded whilst their fader knobs are being touched.

#### 5 TOUCH HOLD Push-Button

Latch **[TOUCH HOLD]** to set any number of faders to have their touch function set on permanently, which is indicated by the yellow touch LEDs.

Once a number of faders have been set in Touch Hold, this button can be de-selected. Their touch status will be retained, indicated by yellow LEDs. This function allows a new balance to be set irrespective of underlying automation data.

Latch the **[TOUCH HOLD]** button at any time and touch any individual fader knobs to take them out of Touch Hold.

#### 6 TOUCH CLEAR Push-Button

This momentary button clears all faders of Touch Hold.

## 7 AUDITION Push-Button

The audition function works for any automated fader or knob which is in a 'ready' state i.e. its red or green LED is flashing. When this button is latched on, touching a fader or moving a knob puts it into audition mode. Audition is designed to be used when revising mixes.

In ready **ABS Audition** mode, the current absolute fader/knob position will override any automation playback, allowing an absolute auditioned setting to be established. The tape can then be rolled back and the fader dropped in to record the new absolute setting or moves.

In ready **TRM Audition** mode, the point at which the fader/knob is touched becomes the null point, allowing a trimmed audition setting to be established based on the underlying mix. The tape can then be rolled back and the fader dropped in to record the new trim setting or moves.

Faders and knobs **ABS** or **TRM** ready will operate in audition mode until **AUDITION** is de-selected.

### To record auditioned levels from a specified time

- 1 Set an in-point from which the auditioned levels are to be written e.g. set a Cue point with **A** **ENTER**. Cue points already available in the Cues List may be used or a timecode point can be entered.
- 2 Having made sure that **AUDITION** is selected, set the fader balance for any faders in ready **ABS** or **TRM** mode as desired.
- 3 Enter the following command using the Control Keyboard. A is assumed as the time point in the following example but Cue or timecode entries are 'legal' too: **MIX** **A** **ENTER**

The system will then roll back past point A to include the Pre-Roll Time and then play forward. The previous automation balance will be heard up until point A. At point A the auditioned faders will drop into automation write and the previous balance will change to the new audition levels.

### To record auditioned levels between specified times

- 1 Set an in- and an out-point from which the auditioned levels are to be written e.g. set Cue points with **A** **ENTER** and **B** **ENTER**. Cue points already available in the Cues List may be used or timecode points can be entered.
- 2 Having made sure that **AUDITION** is selected, set the fader balance for any faders in ready **ABS** or **TRM** mode as desired.
- 3 Enter the following command using the Control Keyboard. A and B are assumed as the time points in the following example but Cue or timecode entries are 'legal' too: **MIX** **A** **B** **ENTER**

The system will then roll back past point A to include the Pre-Roll Time and then play forward. The previous automation balance will be heard up until point A. At point A the auditioned faders will drop into automation write and the previous balance will change to the new audition levels. At point B the faders will drop out of automation write and the previous underlying balance will be heard once more.

# 7-7 Dynamic Automation Moves

## 7-7-3 To Automate Cuts

Cuts may be set up for automation in two ways: using the local **ABS** (absolute) and **TRM** (trim) buttons above the faders or using the master keys, **READY ABSOLUTE** and **READY TRIM** buttons beneath the central LCD screen. The method for local buttons will be described first.

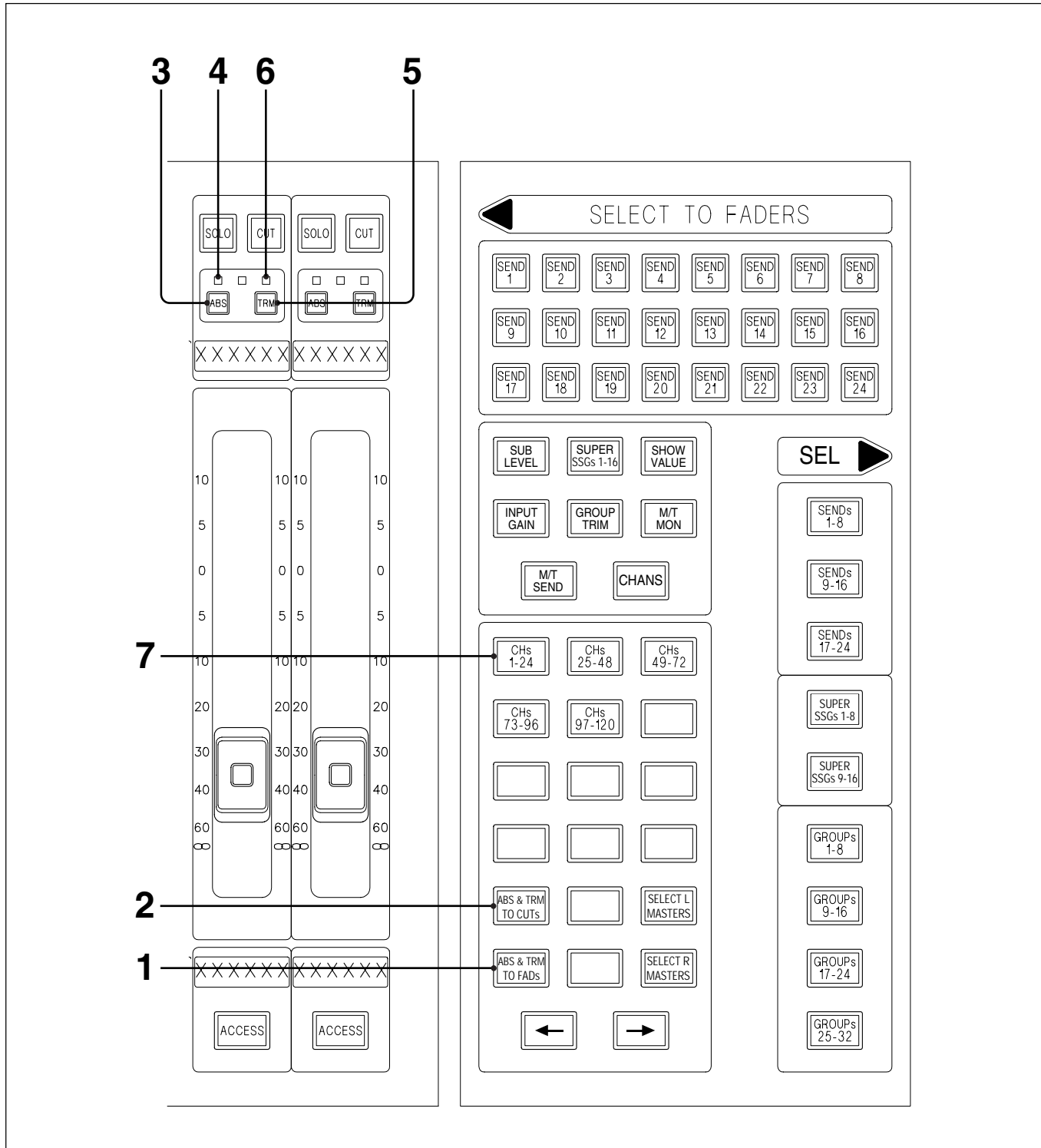

Setting automation of Cuts locally

## To set up Cuts for automation locally

See the diagram - 'Setting automation of Cuts locally'.

- 1 The **ABS** and **TRM** buttons above the faders are assigned to the faders by default. **ABS + TRM TO FADs** will be lit to indicate this.
- 2 Press **ABS + TRM TO CUTs** to assign the **ABS** and **TRM** buttons to the cuts.
- 3 Press **ABS** for the cuts to be automated where new data is to be written. This will overwrite previous data.
- 4 Their red LEDs flash to indicate their 'ready' status.
- 5 Press **TRM** for cuts to be automated where cut data is to be modified or added to.
- 6 Their green LEDs will flash to indicate their 'ready' status.
- 7 To set a bank of 24 cuts into 'ready' status, press and hold **CHS 1-24**, for example, until it turns amber and then press any **ABS** or **TRM**.

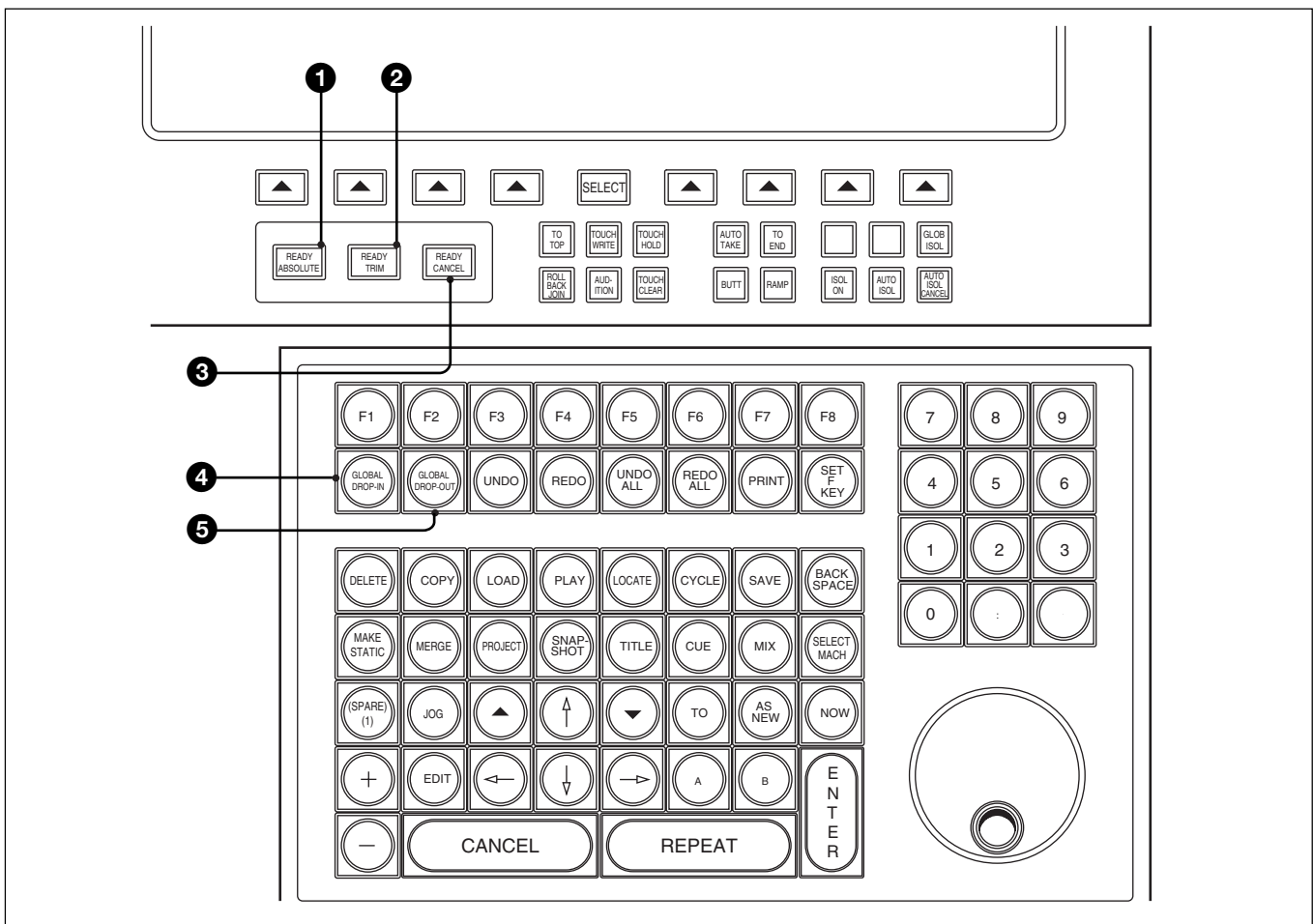

Automation master keys

## To set up Cuts for automation using the central master keys

### 1 READY ABSOLUTE Push-Button

This latching button allows the user to set cuts into an 'automation ready' state where new cuts can be written which will overwrite previous data. If any cuts were already lit, their lights will go out for the set-up during the period that **READY ABSOLUTE** is latched.

Latch **READY ABSOLUTE** and press any cuts to be automated and they will flash to show that they are enabled. When **READY ABSOLUTE** is pressed again, de-selecting it, the enabled cuts return to their previous states. Rolling the tape causes **READY ABSOLUTE** to be de-selected automatically.

## 7-7 Dynamic Automation Moves

### 2 READY TRIM Push-Button

**READY TRIM** works in the same way as **READY ABSOLUTE**. It allows cuts to be set up such that existing cuts can be modified, or additional cuts created, without overwriting previous cut data.

### 3 READY CANCEL Push-Button

**READY CANCEL** takes all controls out of the 'ready' state and returns them to a 'safe' mode.

### 4 GLOBAL DROP-IN Key

**GLOBAL DROP-IN** puts the cuts which are set up 'ready' into write and can be actioned either before the tape is rolling or while it is rolling. Once **GLOBAL DROP-IN** is selected, the cuts can be actioned, whilst the tape is rolling. To revise any cuts, roll the tape back and play again. The cuts will be replayed and none will be overwritten until **GLOBAL DROP-IN** is pressed once more.

Alternatively, an individual switch will drop into automation record at the moment it is pressed, changing its state at the same time.

#### Note:

The state of a switch can be retained when dropping in using **READY ABSOLUTE** by holding its **ABS** button whilst pressing the switch.

### 5 GLOBAL DROP-OUT Key

**GLOBAL DROP-OUT** causes all controls to drop out of automation record.

#### To automate cuts

- 1 To start at the beginning of the Title, on the Control Keyboard press:  
**LOCATE** **TITLE** **ENTER**  
or:  
**LOCATE** **ENTER**  
to locate to the last entered starting time.
- 2 'Ready' enable the cuts to be automated with **READY ABSOLUTE** (or **READY TRIM**), or 'Ready' enable cuts using the 'local' method described at the beginning of this section.
- 3 Press **GLOBAL DROP-IN** either before or after rolling the tape to drop all 'ready' enabled cuts into automation record, or press switches individually.

- 4 Write cuts as required.

#### Note:

To audition a channel which is cut, assign the Definable Knobs to **INPUT GAIN** and press **AFL** on the appropriate channel.

- 5 Press **GLOBAL DROP-OUT** after writing cuts.
- 6 Press **PLAY** **ENTER** on the Control Keyboard to hear the result and note that automated cuts are indicated by switches lighting amber.
- 7 Roll back and repeat **GLOBAL DROP-IN** until the cuts are satisfactory.
- 8 Press **READY CANCEL** **ENTER** once cuts have been completed.

#### Note:

As soon as any automation has been recorded, the message '(New) 1 DYNAMIC LAYER' is displayed on the MIXES & CUES GUI at the top right, to indicate that unsaved automation data is resident in the system.

#### UNDO and REDO functions

As passes are made by rolling forwards and back, a set of unsaved passes is built up which is resident in the system memory. Use **UNDO** to step backwards through individual passes to the last **SAVE** command and **REDO** to go forwards. Press **UNDO ALL** to go all the way back in one step and **REDO ALL** to go all the way forwards in one step.



## How to modify cuts using READY TRIM

### Note:

Although it is often easier to rewrite cuts rather than modify them, the following online functions are available. (Offline adjustments can be made using the OFFLINE: CUTS GUI).

- 1 'Ready' Trim enable the cuts to be automated with the central **READY TRIM** button, or 'Ready' Trim enable the cuts using the 'local' method described at the beginning of this section.
- 3 Press **GLOBAL DROP-IN** either before or after rolling the tape to drop all 'ready' enabled cuts into automation record, or press switches individually.

- 4 Press **GLOBAL DROP-OUT** after writing cuts followed by **PLAY** **ENTER** to hear the result and note that automated cuts are indicated by switches lighting amber.
- 5 Roll back and repeat **GLOBAL DROP-IN** until the cuts are satisfactory.
- 6 Press **READY CANCEL** **ENTER** once cuts have been completed.

### Note:

The bi-colour LEDs in the cut switches help with the operation of these functions. The red light indicates manual actions and amber those being performed by the computer. Extra bright red/amber indicates simultaneous manual and computer control.

### To add a new cut:

Adding a new cut in between previous cuts, with no overlap, is straightforward. Implement as previously described.

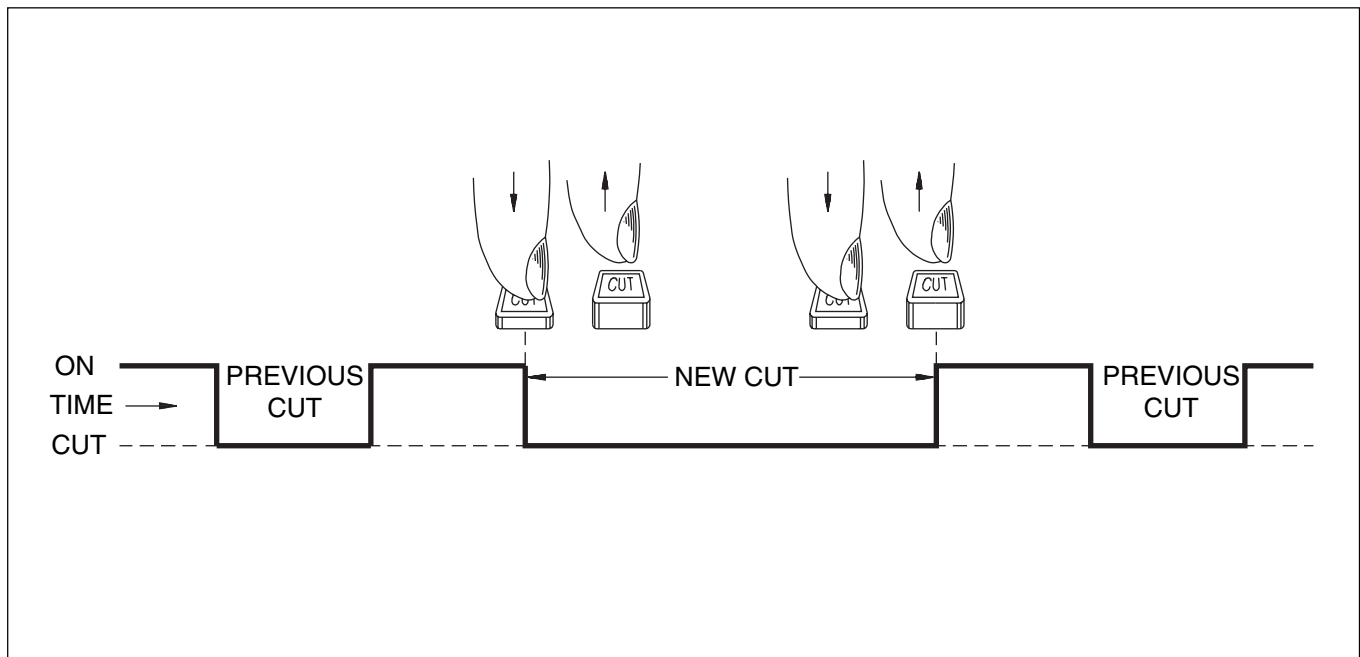

## 7-7 Dynamic Automation Moves

### Advance the in-point:

Push the CUT switch earlier and hold until the original in-point is passed, then release.

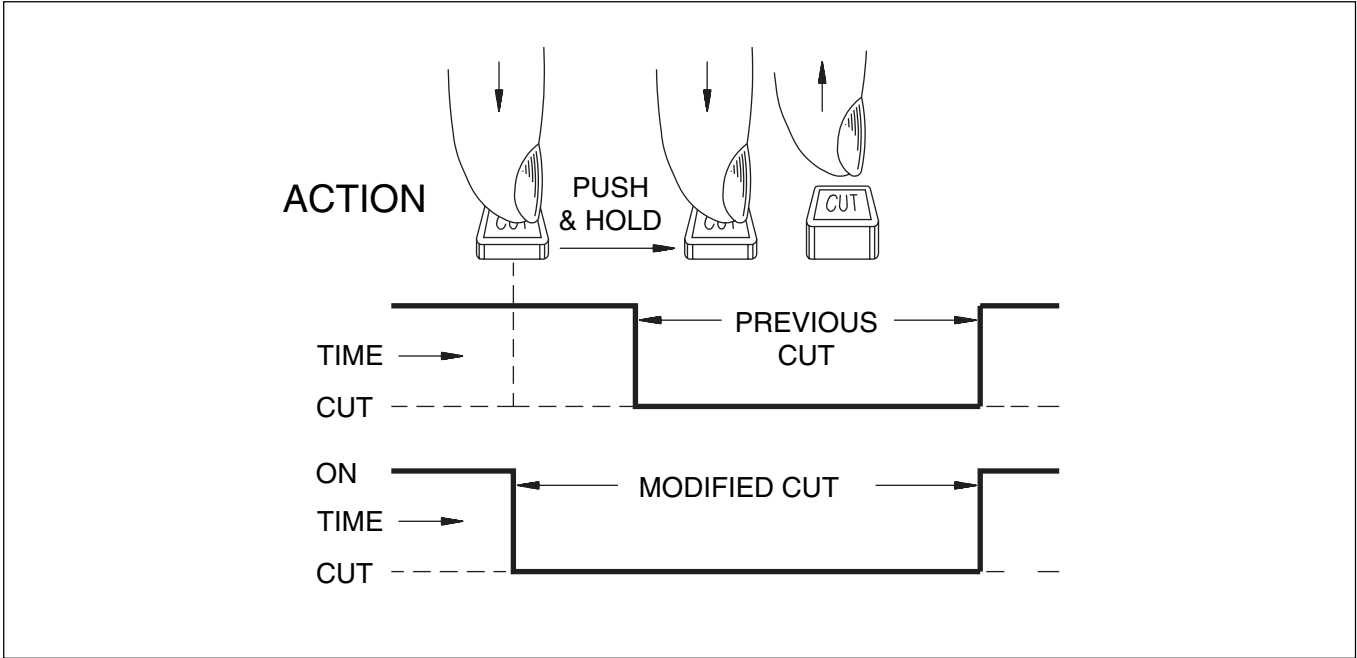

### Advance the out-point:

Push the CUT switch and hold during the original cut, then release at the new (earlier) out-point.

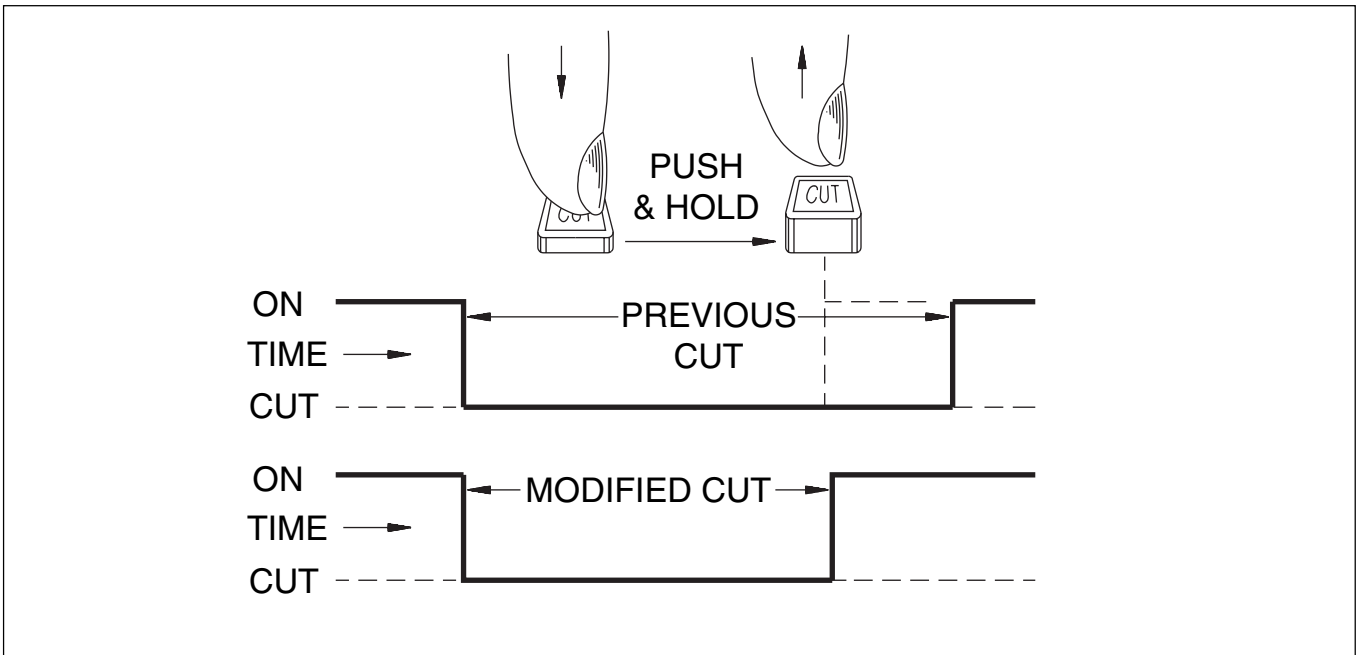

**To make a cut longer:**

Push and hold the CUT switch during the original cut.  
Release at the new (later) out-point.

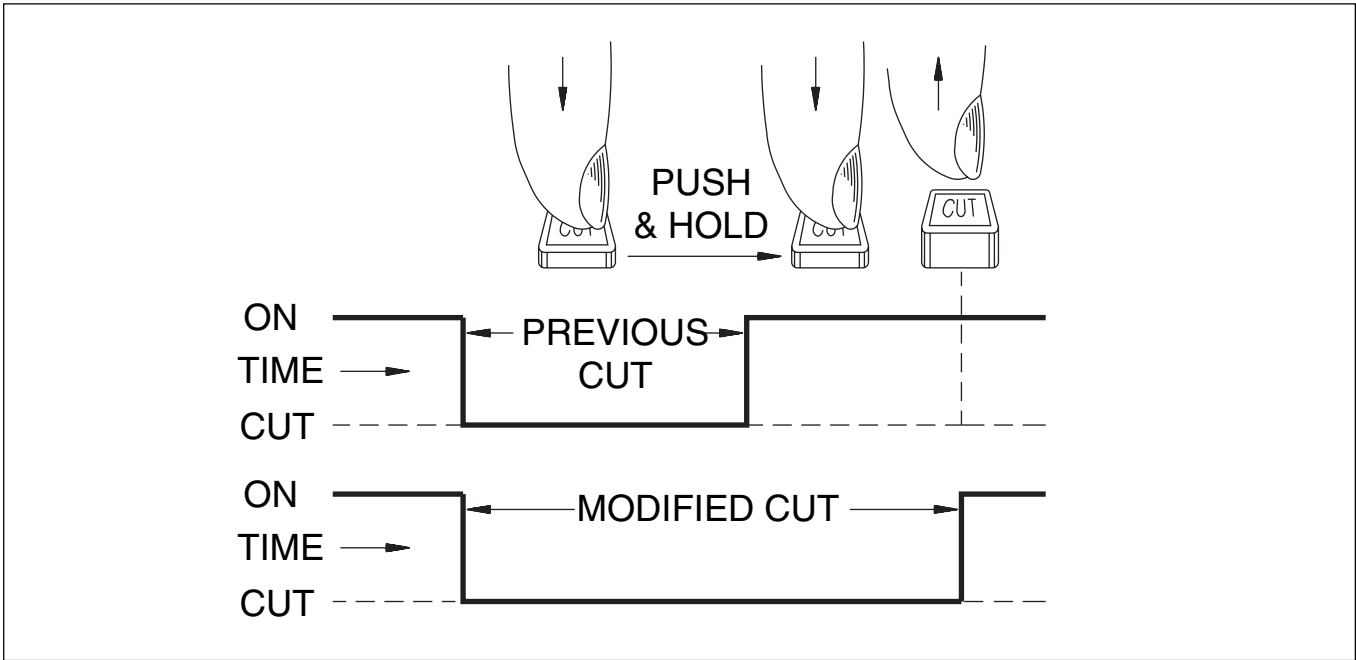

**To erase a cut completely:**

Push and hold before the original in-point and release after the original out-point.

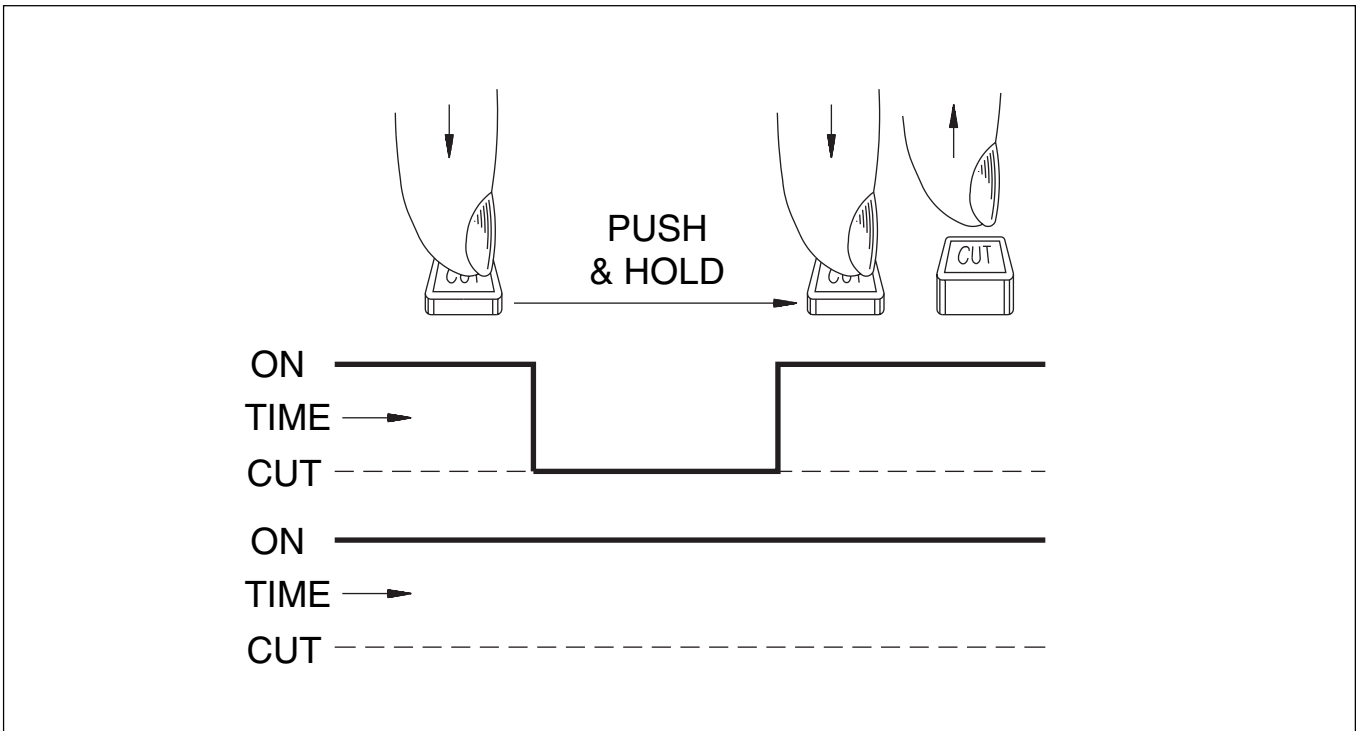

## 7-7 Dynamic Automation Moves

### 7-7-4 To Automate Other Switches

This works in exactly the same way as for CUTs but note that all switches except CUTs, which can be assigned to Faders, must be set up using the global **READY ABSOLUTE** and **READY TRIM** buttons beneath the central LCD.

Other switches which can be automated currently include:

- **Channel Pan IN/OUT switches**
- **Multitrack Cuts**
- **Multitrack Pan IN/OUTs including Surround**
- **Multitrack Send Cuts**
- **Send Cuts and Pan IN/OUTs**
- **The 8 IN Buttons (Input Channel & Inserts panel)**
- **The Equaliser IN/OUTs and A/B switches**
- **Dynamics switches (2 state)**
- **MIC, M/T and LINE Input Selector switches**
- **Switches assigned to MIDI**

#### **Select Master** **READY ABSOLUTE**

All automatable switches which are lit will go out. Select the switches to be automated by pressing them; they will flash indicating that they are in Ready Absolute mode. De-select **READY ABSOLUTE** and all switches return to their previous status.

#### **Select** **GLOBAL DROP-IN** (Control Keyboard)

This puts the switches into write and can be done before or after the tape is rolling. Switches can be put into write individually as they are pushed, they will change state simultaneously. Roll the machine with its remote and perform the switch actions.

#### **Check which switches are being automated**

To check which switches have been set up for automation, press master **READY ABSOLUTE** and just those switches in ready or write will flash. When the tape is in play, **READY ABSOLUTE** has a momentary action.

#### **To revise any switches**

To revise any switches, roll back and play again. The automated switch actions will be replayed. They will illuminate amber indicating control by the automation system.

Nothing will be overwritten until **GLOBAL DROP-IN** is pressed once more or switches are pressed individually when they will drop into write and change state simultaneously.

**GLOBAL DROP-OUT** may be used to drop back to a safe Ready state at any time.

#### **To finish**

After pressing **GLOBAL DROP-OUT** to drop all controls out of automation record, select **READY CANCEL** to make all switches 'safe'.

#### **Note**

**READY CANCEL** will work only for switches in a Ready state. Switches in automation write will not be affected.

#### **Switching manually when automation moves are present**

Once automated switch moves are 'safe', the switches can be operated manually at any time. The highest priority is given to manual operation which, although it will override automation, will not overwrite the automation data.

#### **Note**

To trim automated switch actions use the procedure as described above except substitute **READY TRIM** for **READY ABSOLUTE**.

## 7-7-5 To Automate a Pan Move (or any other knob)

The principles for automating knobs are the similar to those for faders, but note that all knobs, except levels which can be assigned to Faders, must be set up using the global **READY ABSOLUTE** and **READY TRIM** buttons beneath the central LCD.

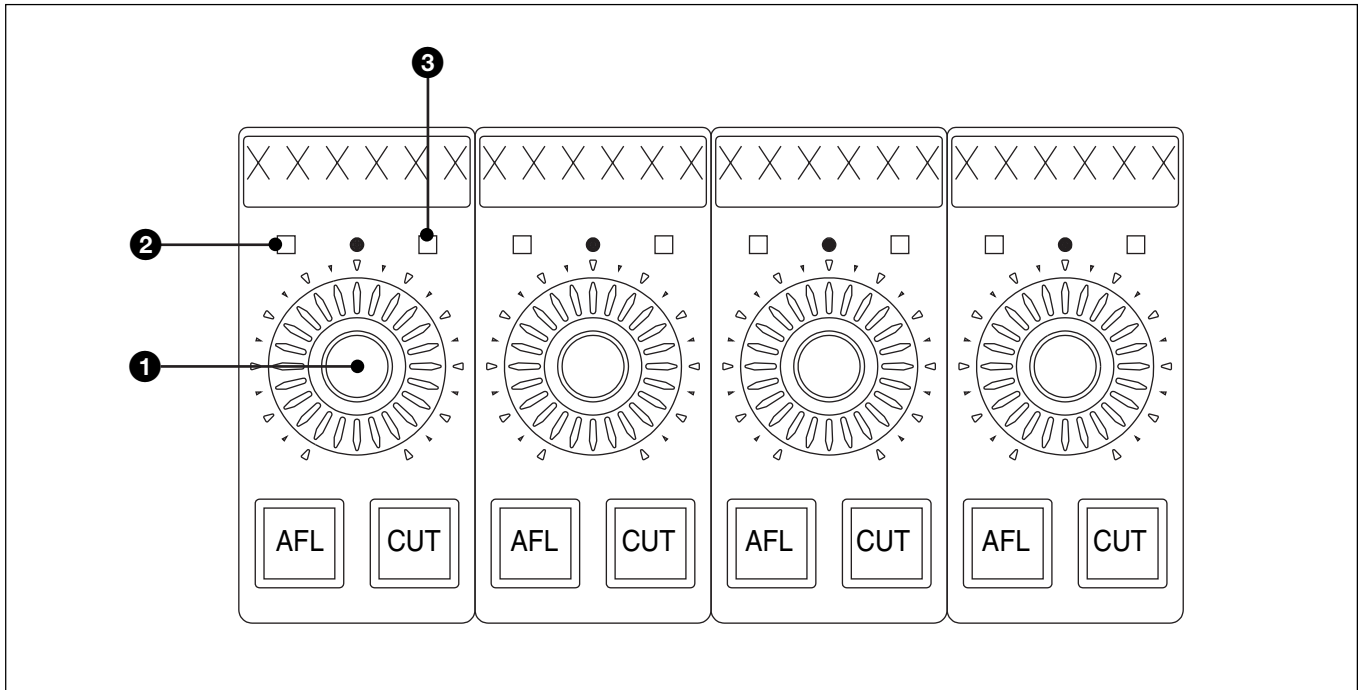

Functions for automating knobs illustrated with a Pan knob

Other knobs which can be automated currently include:

- Channel Pans
- Multitrack Pans including Surround Pans
- Multitrack Send Levels
- Send Levels
- Equaliser Knobs
- Dynamics Knobs
- Delay Knobs
- Knobs assigned to MIDI

### Switch and displays for automating knobs

#### 1 Write Switch

Press knob to switch for Automation write.

#### 2 Red Absolute LED

#### 3 Green Trim LED

### To automate a PAN (or any other knob)

- 1 Latch the **READY ABSOLUTE** button on the panel below the central LCD and push the PAN knob. Its red LED flashes to show that it is in ready absolute mode. De-select **READY ABSOLUTE** or play the tape when it will de-select automatically.
- 2 Press the PAN knob again either before or after the tape is rolling and the LED will light full on, indicating that moves will be recorded. Make the desired moves.
- 3 To revise moves, roll back and press the knob once more. Whilst the tape is rolling back, the red LED will flash again. Either whilst the tape is stopped, or when it is playing again, press the PAN knob once more and its LED lights solidly indicating the absolute write function overwriting previous moves. Roll-back for the knobs works in the same manner as for faders, except that instead of the knobs moving, the LEDs in the skirt of the knob reflect previous move data.

## 7-7 Dynamic Automation Moves

### 7-7-6 Dropping Out of Write on Subsequent Mix Passes for Knobs

As with the faders, there are four ways to drop out of automation write for knobs (see section 7-7-2 for more details). The switches are just to the right of centre beneath the central LCD.

- **BUTT**  
Where a jump occurs at the drop-out point (current default).
- **RAMP**  
Where a user defined time is taken to slew to the previous move. To adjust, click on **RAMP TIME** on the Mixes & Cues page to display the dialogue box.
- **AUTO-TAKE**  
Where the operator manually moves the knob to the previous move. When the PAN button is pressed in this mode, the knob does not drop out of write immediately. Instead, the 6-character display above the PAN knob indicates the direction in which to rotate the knob. As the knob is turned, it drops back to ready just when it matches the original position, indicating by the appropriate changing state from being lit solidly to flashing.

#### Note

*Knobs other than PAN do not currently display which direction a knob should be rotated in order to match previous data.*

- **TO END**  
Where the knob position at the drop-out point is recorded to the end of the Title.

When the moves are complete, press the PAN button to drop out of write and the red LED flashes. Then press **READY CANCEL** on the panel below the central control screen to make the pan completely 'safe'.

- **TO TOP**  
To Top is a related function allowing knob position to be recorded from any point within the Title to the beginning, for both absolute and trim modes.

If a knob is in automation record then it is the point at which **TO TOP** is pressed which determines the absolute level or trim offset. If **TO TOP** is already on then it is the point at which the knob is dropped into record.

### 7-7-7 To Trim Pan Moves (or any other knob)

- 1** Latch the master **READY TRIM** button on the panel below the central LCD, then press the PAN knob and its green LED flashes indicating ready trim. De-select **READY TRIM** or allow it to de-select automatically when the tape is played.
- 2** Press the PAN knob either before or after rolling the tape and its green LED lights solidly indicating that any trimming moves will be recorded. Whilst the knob is in the ready trim state, the LEDs will indicate previous moves. The position of the knob at the drop-in point i.e. when the knob is pressed, becomes the null point for any trimming moves.
- 3** When the moves are complete, press the PAN knob to drop back to ready indicated by the green LED flashing again, then press **READY CANCEL** on the panel below the central LCD to drop out completely.

## 7-7-8 Automation Off and Selective Automation Isolate

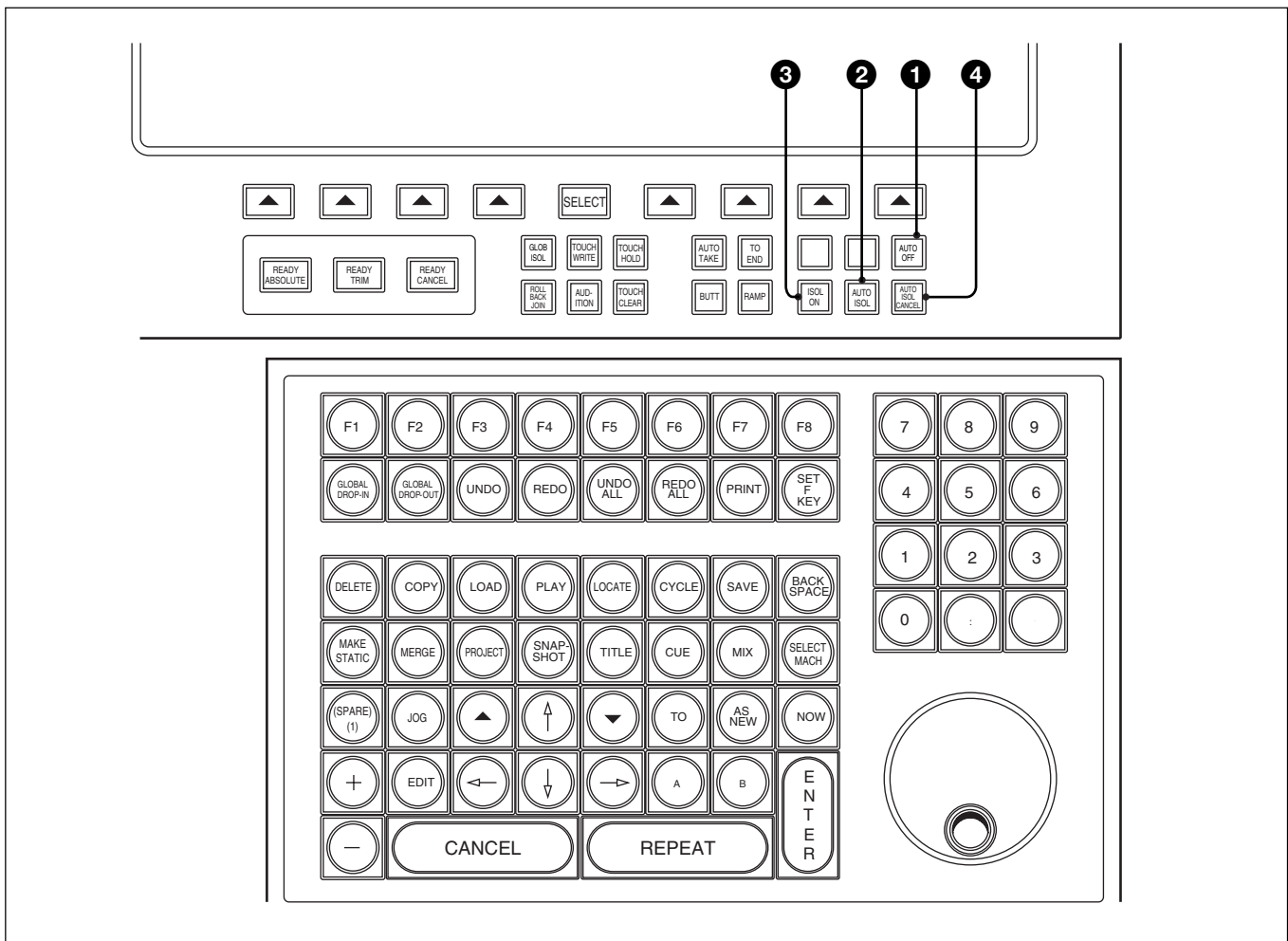

Automation Off and Isolate set-up buttons

### Automation Off

#### ❶ AUTO OFF Push-Button

Press **AUTO OFF** to isolate automation control of the whole console, setting all controls to a static mode when they can be freely adjusted. In other words, even though automation moves have been recorded, the controls stay wherever they are set. This function is useful to find a new static starting point where a dynamic mix is not felt to be going in the right direction. A further use for Automation Off is to enable the balance to be changed for a short while, in an over-dub situation for example. Any automation data is still resident and can be re-invoked at any time by de-selecting **AUTO OFF**.

### Selective Automation Isolate

This function allows individual channels with automated controls to be isolated from the control of the automation system during playback.

When channels are taken out of isolate, their objects (such as faders) switch back to the state (playback, ready abs, ready trim, etc.) that they were in before being isolated. The exceptions to this are controls in the active state of recording automation data when isolate is selected, in which case they default to play.

#### ❷ AUTO ISOL Push-Button

Latch **AUTO ISOL** to set up the channels to be isolated. Select the lower **ACCESS** buttons for the channels to be isolated. They stay lit. De-select **AUTO ISOL** when the channels have been selected. Select again to add or subtract channels.

## 7-7 Dynamic Automation Moves

### 3 ISOL ON Push-Button

Select **ISOL ON** to actually isolate the channels selected from their automation data. De-select **ISOL ON** to re-invoke automation data to the isolated channels.

### 4 AUTO ISOL CANCEL Push-Button

Touch **AUTO ISOL CANCEL** to delete the current channels set up for the Isolate function in readiness for another selection.

#### Note

- 1 *AUTO ISOL can be pressed at any time to check which channels are isolated. It has a momentary action whilst the tape is rolling.*
- 2 *Saving a MIX or SNAPSHOT will cause the isolated settings to be stored. A COPY from an isolated channel will also take the isolated settings.*
- 3 *Loading a MIX or SNAPSHOT will cause the isolated settings to be overwritten. A COPY to isolated channels will overwrite isolated settings.*

## 7-7-9 Film Mode

### General

In Film Mode, Faders Cuts and Pans are isolated from **GLOBAL DROP-IN**, **GLOBAL DROP-OUT** and **READY CANCEL** for Audition functions.

#### Note

*Film Mode is operational only whilst **AUDITION** is selected.*

Faders, Cuts and Pans can still be automated at the same time as other controls, but on a local basis. In other words, faders can be left 'ready enabled' or in Touch Write and **READY CANCEL** will not affect them, for example.

### To enable or disable Film Mode

Type **F**, **I**, **L**, **M** and **ENTER** on the QWERTY keyboard for a pop-up requesting confirmation. Click on OK or press **ENTER**. Use the same command line to disable if already enabled.

### Film Mode for Knobs

Turning any knobs will set them into ready absolute mode indicated by their red LEDs flashing. The effect they will have on the audio will also be heard, or auditioned. Once satisfactory, press **GLOBAL DROP-IN** to write the auditioned settings, indicated by the red LEDs lighting solidly. When the new setting is written press **GLOBAL DROP-OUT** to drop back to ready and knobs return to their previous settings. Press **READY CANCEL** to return to a 'safe' mode.

#### Note

***READY CANCEL** will not work for knobs with an audition setting. To return a knob to its previous non-audition setting de-select and re-select **AUDITION**.*

### Film Mode for Switches

Pressing a switch will change its state from on to off or vice versa and set it into ready absolute mode at the same time. Its effect will also be heard or auditioned. Press **GLOBAL DROP-IN** to write the new setting and **GLOBAL DROP-OUT** when complete. The switch will return to its original state. Note that the switch will still be in a ready status. This can be verified by selecting **READY ABSOLUTE**, when all switches in ready absolute will flash. Press **READY CANCEL** to return to a 'safe' mode.

#### Note

***READY CANCEL** will not work for switches with an audition setting. To return a switch to its previous non-audition setting de-select and re-select **AUDITION**.*

### Copy Audition values

QUICK COPY (see section 7-6-8) used in Film Mode works on automation ready controls only. The following conditions must be in place:

- **Film Mode** must be enabled.
- **AUDITION** must be set on.
- **COPY STATIC** must be set on, or both **COPY STATIC** and **COPY DYN** must be set to off.

In this case QUICK COPY functions will copy the Audition settings only from those controls set in automation Ready ABS and Ready TRIM. The destination controls will be set into Ready ABS and TRIM during the QUICK COPY operation.



## 7-7-10 Global Ready Enable

Setting all or a large number of controls into an automation 'ready enabled' is possible using the GLOBAL READY ENABLE GUI and also by keyboard entry.

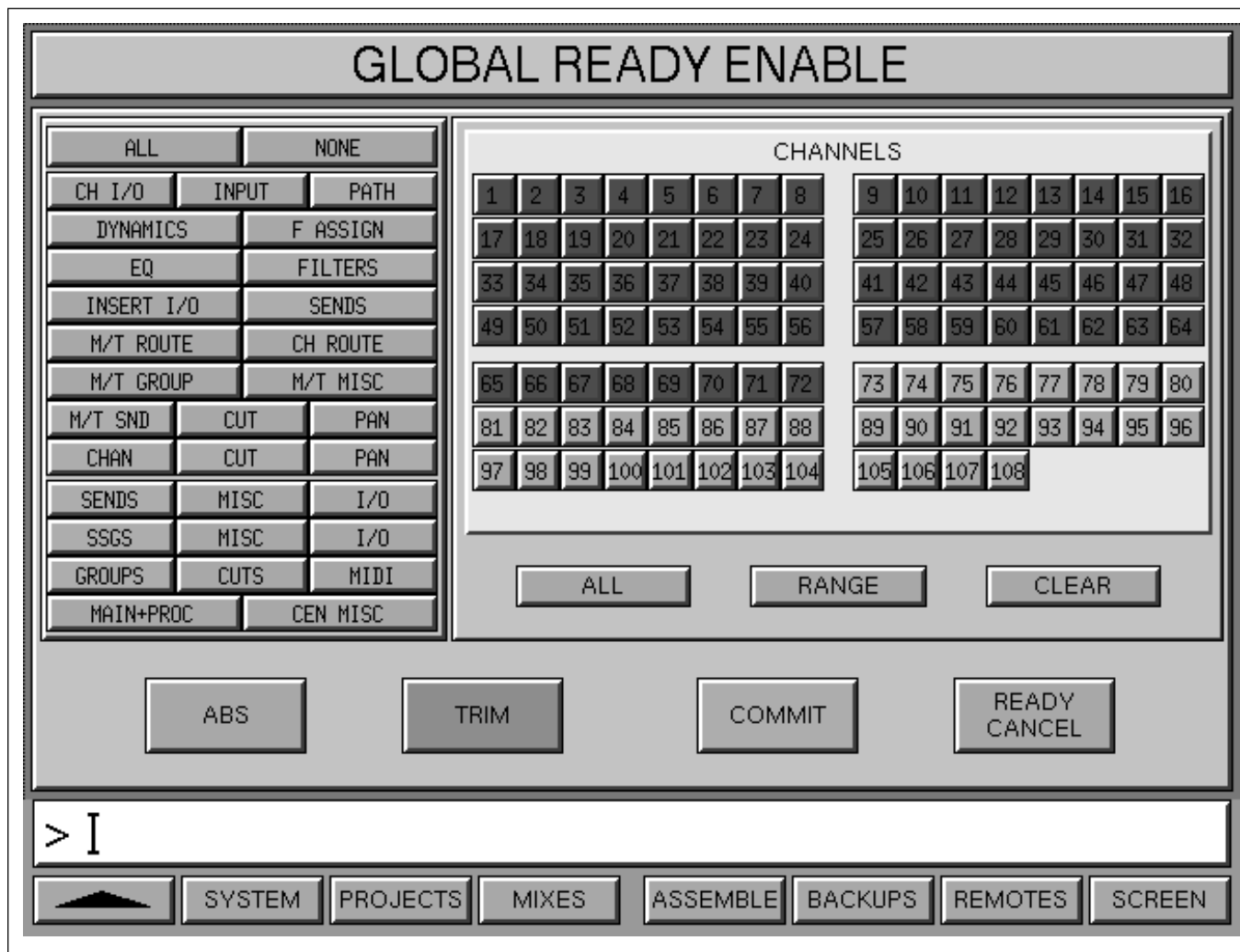

GLOBAL READY ENABLE GUI

### General

This GUI allows the setting up of automation 'ready enable' in Absolute or Trim modes for:

- **The Complete Console**
- **Ranges of Channels**
- **Individual Channels**
- **All Controls for Selected Channels**
- **Sections of Controls for Selected Channels**
- **Key Individual Controls for Selected Channels**

### Using GLOBAL READY ENABLE GUI

Select the GUI using the GLOBAL softkey at the bottom of the SNAPSHOTS, COPY & LINK GUI or press the SCREENS softkey at the bottom right of the central LCD. Then click on GLOBAL ENABLE or use the ▲ and ▼ keys on the Control Keyboard to move the highlight to GLOBAL ENABLE and **[ENTER]** on the Control Keyboard.

### ABS or TRIM

When the GUI appears the ABS (absolute) button will be lit red as the default mode. Click on TRIM for Trim mode, which lights green and inter-cancels with ABS.

## 7-7 Dynamic Automation Moves

### Selecting Channels

Channels can be selected individually by clicking on appropriate numbers to highlight them, or clicking on ALL and then de-selecting individual channels if more convenient.

To select adjacent channels in a block, click on RANGE which highlights orange. Then click on the first and last of each block. De-select RANGE when finished.

As soon as any channels are selected the COMMIT button lights orange and clicking this will action the ready enable function. But first make sure the correct control types are highlighted in the selector block to the left.

### Selecting Controls

The control types are selected using the block on the left of the GUI. Click on the appropriate buttons to highlight in orange the channel sections required, such as EQ and Dynamics.

Click on ALL to highlight the complete channel then de-select the sections not required or, if more convenient, click on NONE to de-select all sections and then click on the ones required.

### CHANNEL Selector

Below is a brief description of what control types each button will select.

#### Note

*Some of the controls, such as Routing Switches, are not automated dynamically but will be loaded as Snapshot Automation. Each section below is annotated accordingly.*

#### ALL

- Highlights All Channel Controls and I/O.

#### CH I/O (Snapshot)

- Channel Input sources and Output destinations, with gain settings (not channel insert).

#### INPUT (Dynamic)

- Mic, Line and M/T input selector and Phase switches.

#### PATH (Dynamic)

- 8 section Channel Path selector and IN buttons.

#### DYNAMICS (Dynamic)

- All Dynamics section controls.

#### F ASSIGN (Dynamic)

- All Free Assign Area controls, currently just Delay in this version.

#### EQ (Dynamic)

- All Equaliser controls (not Filters).

#### FILTERS (Dynamic)

- All Filter controls.

#### INSERT I/O (Dynamic)

- Analogue or digital I/O related to the Channel Insert.

#### SENDS (Dynamic)

- All Send levels, their Pans and Cuts.

#### M/T ROUTE (Snapshot)

- Multitrack Routing.

#### CH ROUTE (Snapshot)

- Channel Routing.

#### M/T GROUP (Dynamic)

- Multitrack Group Cut and Trim

#### M/T MISC (Dynamic)

- Multitrack group monitor levels, Pans and Cuts.

#### M/T SND (Dynamic)

- Multitrack Send Fader.

#### CUT (Dynamic)

- Multitrack Send Cut switch.

#### PAN (Dynamic)

- Multitrack Send Pan setting.

#### CHAN (Dynamic)

- Channel Fader.

#### CUT (Dynamic)

- Channel Cut switch.

#### PAN (Dynamic)

- Channel Pan setting.

**Note**

*Global Ready Enable does not apply to the Centre Section items in the lower part of the selector.*

**Using Keyboard Entry**

Keyboard entry allows 'ready enable' in Abs or Trim for the whole console or specific channels entered using the QWERTY Keyboard. Controls will be enabled according to the CHANNEL Selector described previously.

**To Ready Enable the Whole Console**

At the QWERTY Keyboard type:

**READY** **ENTER**

A confirmation pop-up will appear. Clicking on OK, which is highlighted red, or pressing **ENTER** will set the complete console to 'ready absolute' status.

Clicking on NO gives rise to a further confirmation pop-up to set the complete console to 'ready trim' status. Click on OK or press **ENTER**. NO will cancel the operation.

**To Ready Enable Channels & Control Groups**

Keyboard entry has an additional function allowing Control Group Faders to be specified as well as Channels.

At the QWERTY Keyboard type:

**READY Specify Channels as Below** **ENTER**

- Channels and Control Group Faders:

Ranges are specified with '..' as a separator:

1..72 = Channels 1-72

01..032 = Control Group Faders 1-32

- Individual items are separated by '.'

2 . 4 . 25 = Channels 2, 4, and 25

- Unlimited strings are possible in the same entry:

e.g. 01 . 03 . 05 .. 08 . 1 .. 24 . 48 .. 56 . 65 =

Control Group Faders 1, 3, and 5-8

Channels 1-24, 48-56 and 65

# 7-8 Offline Automation

This screen page allows automation data for Faders and Cuts to be written and modified offline. Click on either FADERS or CUTS as required.

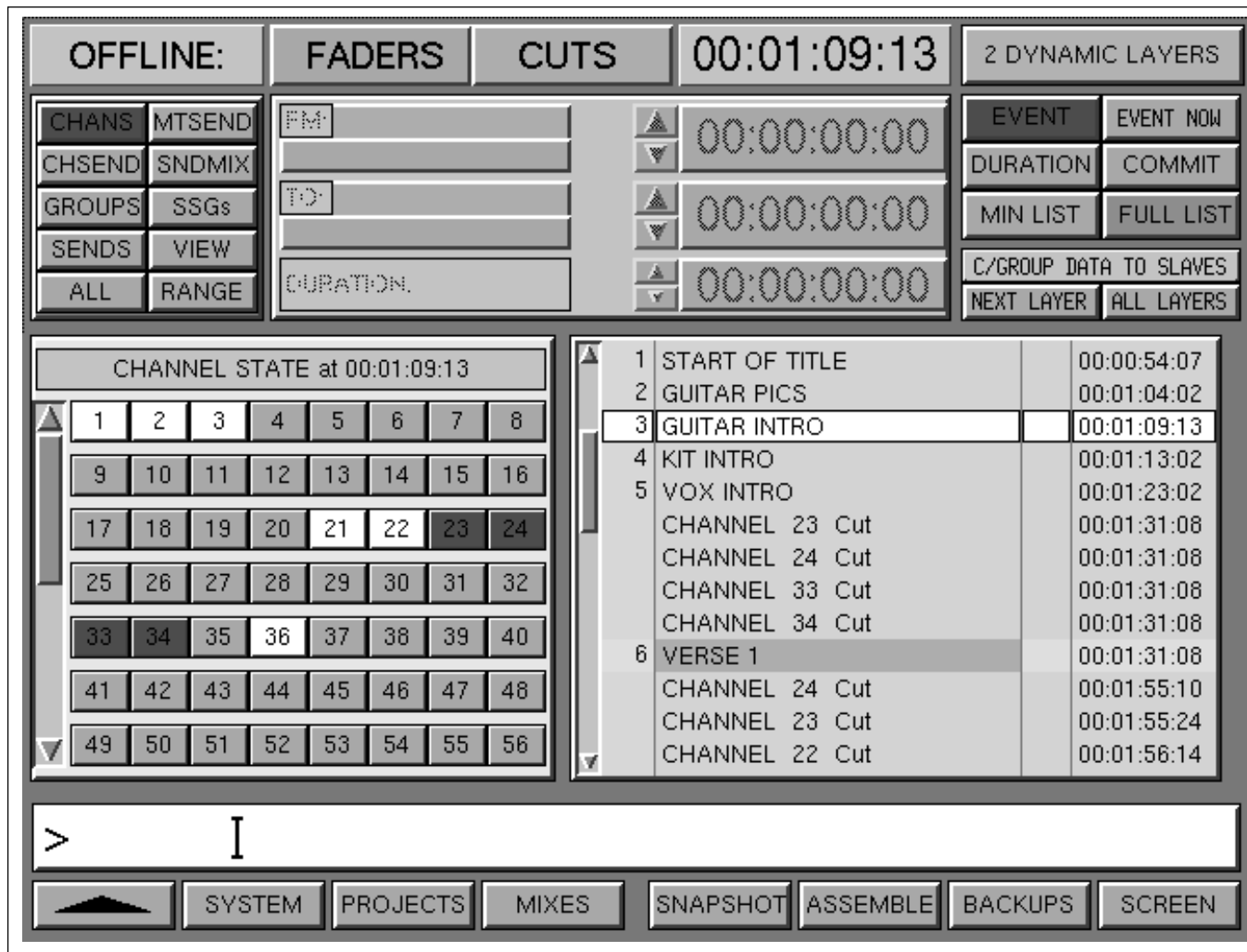

OFFLINE FADERS automation edit GUI

## General

This GUI allows the editing of automation data for selected faders with new or trimmed levels between specified times. Similarly new cut events can be written between specified times and cut transitions can be time-shifted.

**A number of fields in the GUI apply to both Faders and Cuts. These are described first:**

### Control type Selector

Situated in the upper left, this allows selection of fader and cut type e.g. Channel Faders, Control Groups.

### Numbers field

Allows selection of channels to work on, according to the control type highlighted in the upper left selector.

### Upper Timecode bar

Indicates the current timecode for the master machine.

### FM, TO and DURATION

This field (upper centre) allows the start time, end time and duration of an offline operation to be set. This field may also be used to specify a butt or ramp in and out (faders only).

### C/GROUP DATA TO SLAVES

This section (top right of screen) allows control group data to be propagated to slaves. **NEXT LAYER** propagates to the next lowest layer. **ALL LAYERS** propagates to all layers of nested groups such that channel faders alone retain the move and cut data.

## CUES field

This field (lower right of screen), displays the CUES list from the MIXES GUI. During OFFLINE CUTS operations, this list also displays Cut Events in timecode order.

## SELECTOR block

The selector block on the upper left of the screen allows the selection of the control type on which the offline editing will be performed. Only one type of control can be worked on at a time.

<b>CHANS</b>	• Channel Faders & Cuts
<b>MTSEND</b>	• Multitrack Send Faders & Cuts
<b>CHSEND</b>	• 24 Send Levels & Cuts (A Channel must be selected first, then the appropriate Sends)
<b>SNDMIX</b>	• All Channel Levels & Cuts for a Single Send Bus (The Send must be selected first, then the appropriate Channels)
<b>GROUPS</b>	• Control Group Faders & Cuts
<b>SSGs</b>	• Super Send Group Faders & Cuts
<b>SENDS</b>	• Send Bus Output Faders & Cuts
<b>MAIN</b>	• Main Fader
<b>ALL/NONE</b>	• Used in channel selection
<b>RANGE</b>	• Used in channel selection

## To set the duration

Data editing has to be within time constraints. The time can be specified in three ways (FM = from):

### Enter FM and TO

The DURATION is set automatically.

### Enter FM and DURATION

The TO time is set automatically.

### Enter TO and DURATION

The FM time is set automatically.

The FM and TO times can be entered either directly by clicking on a timecode field for a pop-up or by using cue times. Enter a cue time by highlighting that cue in the cues list, then click on the bar below the FM or TO legends to transfer the time. The cue time will be entered and its name displayed. If a timecode set by using a cue is subsequently altered, the cue name will disappear.

To nudge times with the  and  keys on the Control Keyboard, click on a timecode field for a pop-up then nudge as required.

For faders, the transitions can be set as butt or ramp. Click on the butt icon for it to change to ramp and vice versa. Click on the ramp time for a pop-up to set the ramp time. In and out ramps can have different times.

## OFFLINE FADERS EDIT PROCEDURE

### To select Faders

For Channel Faders, click on CHANS in the selector block. It highlights red and the channel faders are displayed in the numbers field. Click on the channels to be worked and they highlight red. Click on them again to de-select.

This procedure also applies to MTSEND, GROUPS, SSGs and MAIN.

### To select Sends

For Send levels for a particular channel, click on CHSEND; it highlights red and the channels are displayed in the numbers field. Click on the required channel and its Sends, 1-24, are displayed in the numbers field. Click on the required Sends and they highlight red.

For a mix of all channels for a particular Send bus, click on SNDMIX; it highlights red and Sends 1-24 are displayed in the numbers field. Click on the required Send and the channels are displayed in the numbers field. Click on the required channels and they highlight red.

### Using ALL, NONE and RANGE

To select all faders of any type, click on ALL and all numbers will be highlighted red. ALL will change to NONE.

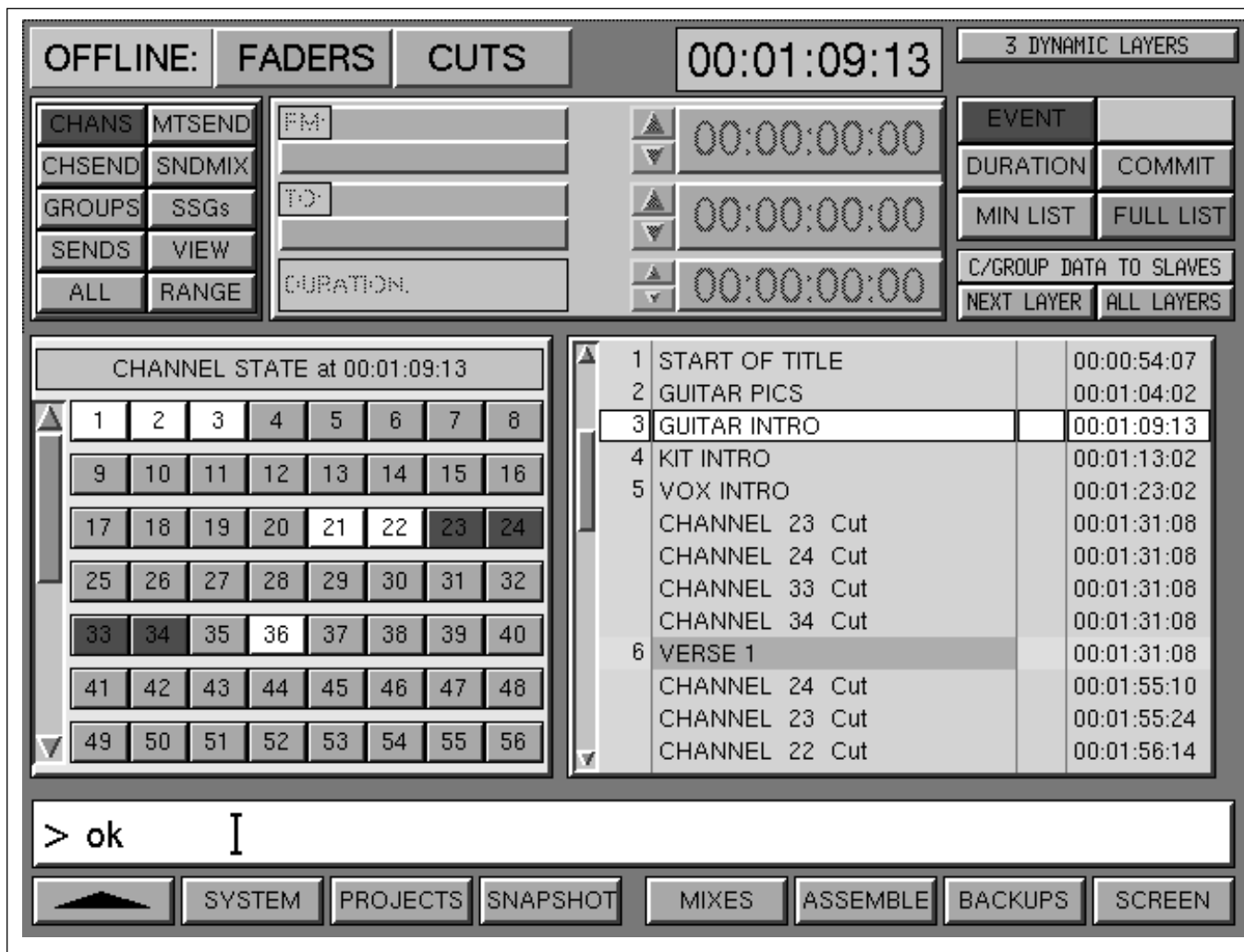

OFFLINE CUTS automation edit GUI

To select a number of consecutive faders, click on RANGE then click, one at a time, on both ends of the range. Separate ranges may co-exist.

### Level Adjustment

Fader levels are set in the upper right hand block. To write new absolute data, click on ABS which highlights red. Then set the level by either clicking on the up/down arrows (below the dB legend), or clicking on the number for a pop-up where it can be typed in or nudged with the **[+]** and **[-]** keys on the Control Keyboard.

To trim previous data, click on TRIM which highlights green. Use the same method for setting the level as with ABS. The level will apply to the faders selected except that the level adjustment will be referenced to the underlying mix.

Once all settings are satisfactory, click on COMMIT and play through the section to check the edit. Repeat the procedure as necessary for other faders and levels.

### OFFLINE CUTS GUI

#### Upper right hand block

The functions of the upper right hand block are specific to Cuts, apart from COMMIT.

#### EVENT

Event mode allows cut events, that is cut and uncut transitions, to be displayed and edited. New cut events can also be inserted.

#### DURATION

Duration mode allows new cut data to be written for a specified duration. Any underlying data within that duration will be overwritten.

## COMMIT

Commit is used to confirm actions as necessary.

## MIN LIST

The list of cut events can be minimised where events occur at exactly the same timecode.

## FULL LIST

Every cut event is displayed individually, even if it occurred at the same timecode as other events. This allows adjustment of every individual event.

## OFFLINE CUTS EDIT PROCEDURE

### To select Fader Cuts

For Channel cuts, click on CHANS in the selector block. It highlights red and the channels are displayed in the numbers field.

### To set the Cuts to be worked on

Click VIEW and it highlights. Then click on the channels to be worked on and they highlight red. Click on them again to de-select them individually.

This procedure also applies to MTSEND, GROUPS and SSGs.

### To select Send Cuts

For Send Cuts for a particular channel, click on CHSEND; it highlights red and the channels are displayed in the numbers field. Click on the required channel and its Sends, 1-24, are displayed in the numbers field. Click on the required Sends and they highlight red.

For a mix of all channels for a particular Send bus, click on SNDMIX; it highlights red and Sends 1-24 are displayed in the numbers field. Click on the required Send and the channels are displayed in the numbers field. Click on the required channels and they highlight red.

### Using ALL, NONE and RANGE

To select all cuts of any type, click on ALL and all numbers will be highlighted red. ALL will change to NONE.

To select a number of consecutive cuts, click on RANGE then click, one at a time, on both ends of the range. Separate ranges may co-exist.

Once the desired cut type and numbers have been selected, click on VIEW again to de-select it. Any events related to the cuts selected in VIEW mode will be displayed in the Cues list.

### Cut EVENT edit

EVENT mode is the default and it will highlight red. Cut events for the selection will be displayed in the list along with the cues, and the current state of the cuts will be indicated in the numbers field according to the following colour coding:

- BLUE** • Uncut without any data written
- WHITE** • Uncut controlled by the automation
- AMBER** • Cut controlled by the automation
- RED RING** • Cut event(s) at the current timecode

#### Note

*A red ring around the outside of a number box indicates the first timecode point for the new state, cut or uncut.*

Automated cut events will be displayed in the numbers field as the tape is rolling and their entry in the cues list will also be highlighted.

#### Note

*The GUI display has a lower priority than the cut events and therefore the screen may not react in real time as the tape is rolling.*

### New EVENT Cuts

Any cuts selected using VIEW which have no automation data (blue coding) can be automated using this GUI. Click on a channel to cycle through:

- RED** • Cut from the highlighted timecode
- WHITE** • Uncut from the highlighted timecode
- BLUE** • No automation

### To Nudge or Change a Cut Event Time

Highlight its timecode entry in the cues list, then use the  and  buttons on the control keyboard to change the time. Alternatively, click on its timecode for a pop-up and nudge to adjust or type in a new timecode.

## 7-8 Offline Automation

### Using DURATION mode for New Cut Data

Use the following procedure to enter new cut data against a specified duration.

### Select the Cut type

Click on DURATION and then select the cut type in the upper left hand selector block.

### Set the Duration

Click DURATION in the upper left selector to set the duration. This procedure is described at the beginning of this section since it applies to both faders and cuts.

### Set cuts and uncuts

Click on the channels of interest. They cycle through 3 states:

- |              |                              |
|--------------|------------------------------|
| <b>RED</b>   | • Cut for the duration       |
| <b>WHITE</b> | • Uncut for the duration     |
| <b>BLUE</b>  | • No change for the duration |

#### Note

*Any underlying data within the duration will be overwritten.*

When the cuts are displaying the desired cut statuses reflected by the colour coding, click on COMMIT to confirm the edit.

### Command Dialogue

At the base of the screen, the User Command Dialogue Line bar displays commands from the dedicated Control Keyboard and QWERTY Keyboard for confirmation before **ENTER** .

### Menu options

Menu options available using the softkey functions displayed at the foot of the Offline screen page are as follows:

- |                 |   |  |
|-----------------|---|--|
| <b>▲</b>        | - | Selects the previous screen page.  |
| <b>SYSTEM</b>   | - | Selects the System screen page directly.   |
| <b>PROJECTS</b> | - | Selects the Artists/Projects & Titles page.  |
| <b>MIXES</b>    | - | Selects the Mixes & Cues page.   |
| <b>SNAPSHOT</b> | - | Selects the Snapshots, Copy and Link page.   |
| <b>ASSEMBLE</b> | - | Selects the mix compilation assembly field and the Mixes & Cues page.                  |
| <b>BACKUPS</b>  | - | Selects system Back-up functions.  |
| <b>SCREEN</b>   | - | Selects pop-up showing all available screen selections. Click on any one to select it. |



# 7-9 MIDI

Two aspects of MIDI are covered by the OXF-R3: control of external MIDI devices on up to 16 MIDI ports via Free Assign Area controls in conjunction with MIDI GUIs, and the display of Bars and Beats in place of timecode.

## 7-9-1 MIDI Control Pages

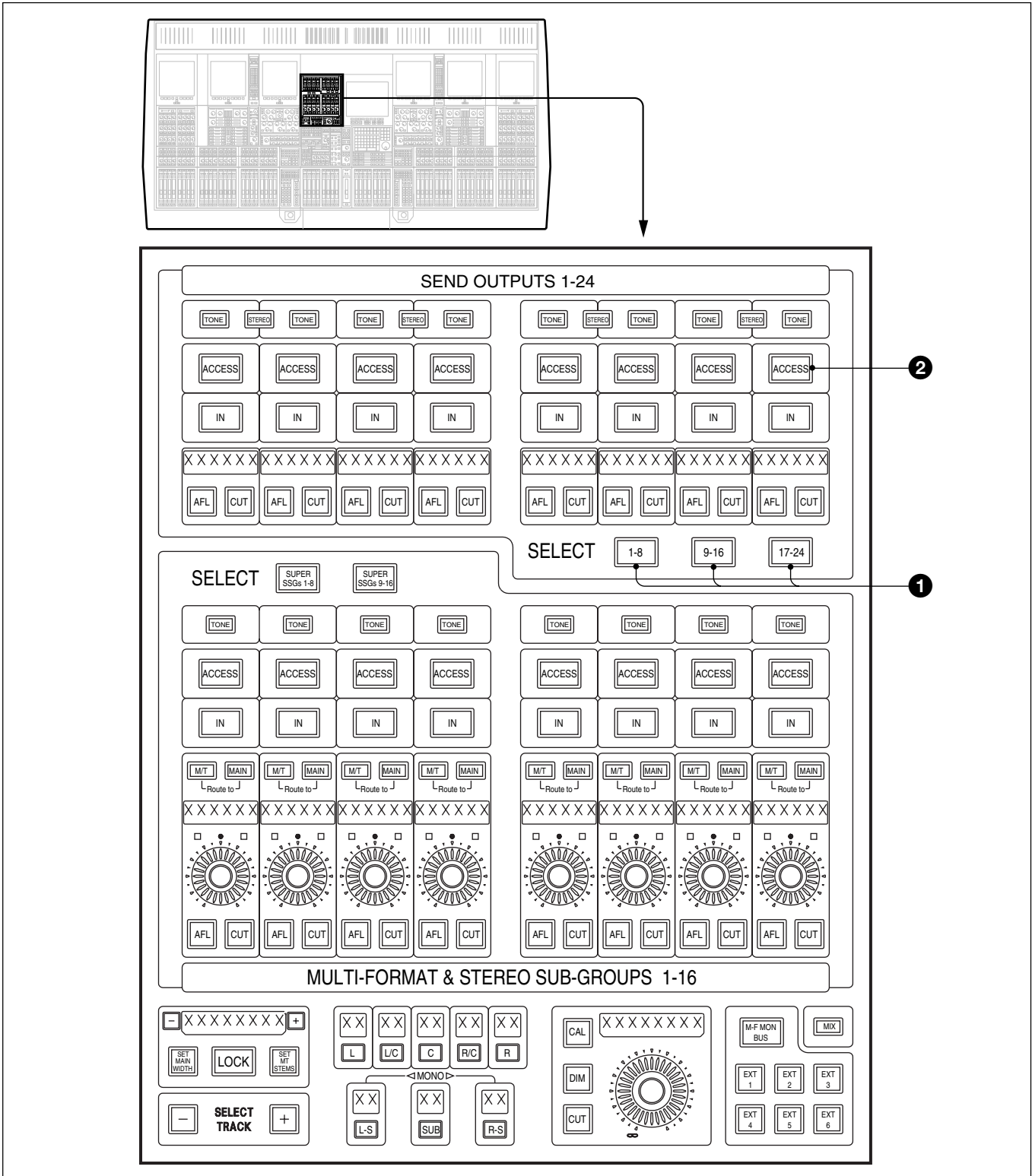

Selecting MIDI Control Pages

### Accessing MIDI Control Pages

Although not directly related, the 24 MIDI Pages are accessed using the **ACCESS** buttons for Send Outputs 1-24.

See the illustration 'Selecting MIDI Control Pages' on the previous page.

### **1-18**, **9-16** & **17-24** Push-Buttons

Allow selection of MIDI Control Page banks.

### **ACCESS** Push-Buttons

Allow selection of individual MIDI Control Pages according to the banks selected. Pages should be displayed on channel LCD screens above the Free Assign Area panels by selecting the appropriate MIDI softkey.

## 7-9-2 Setting MIDI Parameters

### General

The system allows control of MIDI parameters via 6 assignable knobs and 6 assignable switches. Their settings are displayed on the MIDI GUI which is laid out to reflect the positions of the knobs and switches. The MIDI port, channel and command type can be selected for each control as well as 2 parameters for each control.

### GUI Upper Right

The panel at the upper right of the GUI indicates which MIDI page of 1-24 is displayed.

Clicking on **Clear** will select the NOTE OFF command and set all MIDI values to 0.

Clicking on **Enabled** will toggle to **Disabled** switching off transmission of MIDI data. Controls can be adjusted when the **Disabled** flag is displayed.

### SETTINGS for KNOBS **1** and **2**

The settings for the 6 knobs are displayed on the left and right panels in the GUI. Clicking on each field in turn going from top to bottom allows set-up and control as follows:

### CARD (Upper field)

Click on for a pop-up to select the MIDI I/O Port from 1-16. There is one port per Card with a maximum of 16 per system.

### CHANNEL (Second field)

Click on for a pop-up to select the MIDI Channel from 1-16.

### COMMAND (Third field)

Click on for a pop-up to select the MIDI Command type.

### PARAMETER (Fourth field)

Displays a 'first' Parameter depending on which COMMAND type has been selected.

Click on to select the Parameter to the knob for adjustment, indicated by an orange highlight.

### PARAMETER (Fifth field)

Displays a 'second' Parameter depending on which COMMAND type has been selected.

Click on to select the Parameter to the knob for adjustment, indicated by an orange highlight.

### ENABLED [DISABLED] (Sixth field)

Click on to Enable or Disable MIDI control from the associated knob. The Parameter values can be adjusted whilst disabled. The value settings will be transmitted at the point Enable is clicked on.

### SCRIBBLE (Lower field)

Click on for a pop-up to enter an appropriate electronic scribble name which will appear on the display above the associated knob. Either click on a name in the list or click on NEW ENTRY and then use the QWERTY keyboard to type in a new name of up to 6 characters. Then click on OK or press **ENTER**.

### SETTINGS for SWITCHES **3**

The settings for the 6 switches are displayed on the central panel in the GUI. Clicking on each field in turn allows set-up and control as follows:

### CARD (Upper field)

Click on for a pop-up to select the MIDI I/O Port from 1-16. There is one port per Card with a maximum of 16 per system.

MIDI SETUP

SEND: 1

Clear

Enabled

Enabled

CARD 1

CHAN 2

Cont CNG

CHAN VOL

VAL 71

Enabled

WAVSTN

CARD 1

CHAN 1

Note on

E2 (40)

VELO 40

Enabled

K2000

CARD 1

CHAN 10

Cont CNG

BANK SEL

VAL 54

Disabled

SDX

CARD 1

CHAN 1

Key pres

F3 (53)

PRES 61

Enb Latch

EMU E4

CARD 1

CHAN 1

Note off

C-1 (0)

VELO 0

Dis UnLat

SWITCH 2

CARD 1

CHAN 1

Note off

C-1 (0)

VELO 0

Dis UnLat

SWITCH 3

CARD 1

CHAN 1

Key pres

C-1 (0)

PRES 58

Enb UnLat

ASR10

CARD 1

CHAN 1

Note off

C-1 (0)

VELO 0

Dis UnLat

SWITCH 5

CARD 1

CHAN 1

Note off

C-1 (0)

VELO 0

Dis UnLat

SWITCH 6

CARD 1

CHAN 1

Prog CNG

PROG 57

----

Enabled

ASR10

CARD 1

CHAN 1

Pitch bend

LSB 14

MSB 35

Enabled

WAVE

CARD 1

CHAN 1

Note off

C-1 (0)

VELO 0

Disabled

KNOB 6

TOP

SEND

MASTER

FREE ASSIGN AREA & DYNAMICS

WAVSTN	SDX	<p style="margin: 0;">DYNAMICS</p> <table style="margin: 0 auto; border-collapse: collapse;"> <tr> <td style="text-align: center; font-size: 0.8em;">GATE</td> <td style="text-align: center; font-size: 0.8em;">EXP</td> <td style="text-align: center; font-size: 0.8em;">COMP</td> <td style="text-align: center; font-size: 0.8em;">LIMIT</td> </tr> <tr> <td style="text-align: center;">80 60 40 35 30 25 20 15 10 5</td> <td style="text-align: center;">20 18 16 14 12 10 8 6 4 2</td> <td style="text-align: center;">20 18 16 14 12 10 8 6 4 2</td> <td style="text-align: center;">20 18 16 14 12 10 8 6 4 2</td> </tr> </table>	GATE	EXP	COMP	LIMIT	80 60 40 35 30 25 20 15 10 5	20 18 16 14 12 10 8 6 4 2	20 18 16 14 12 10 8 6 4 2	20 18 16 14 12 10 8 6 4 2	ASR10	WAVE
GATE	EXP	COMP	LIMIT									
80 60 40 35 30 25 20 15 10 5	20 18 16 14 12 10 8 6 4 2	20 18 16 14 12 10 8 6 4 2	20 18 16 14 12 10 8 6 4 2									
K2000	EMU E4	ASR10	ASR10	KNOB 6								
	SWITCH 3	SWITCH 4	SWITCH 4									
	SWITCH 5	SWITCH 6	SWITCH 6									

1
3
2

MIDI GUI Page and Free Assign Area (FAA) controls

### **CHANNEL (Second field)**

Click on for a pop-up to select the MIDI Channel from 1-16.

### **COMMAND (Third field)**

Click on for a pop-up to select the MIDI Command type.

### **PARAMETER (Fourth field)**

Displays a 'first' Parameter depending on which COMMAND type has been selected. Click on for a pop-up to select a new Parameter. Click on a suitable entry in the pop-up or click on NEW ENTRY to type in a value using the QWERTY Keyboard. Then click on OK or press **ENTER** .

Every time the switch is pressed the MIDI values displayed will be transmitted provided **Enabled** is set in the sixth field.

### **PARAMETER (Fifth field)**

Displays a 'second' Parameter depending on which COMMAND type has been selected. Click on for a pop-up to select a new Parameter. Click on a suitable entry in the pop-up or click on NEW ENTRY to type in a value using the QWERTY Keyboard. Then click on OK or press **ENTER** .

Every time the switch is pressed the MIDI values displayed will be transmitted provided **Enabled** is set in the sixth field.

### **ENABLED [DISABLED] (Sixth field - left)**

Click on to Enable or Disable MIDI control from the associated switch.

### **LATCH [MOMENTARY] (Sixth field - right)**

The default operation of the switches is a Momentary action when MIDI data is transmitted as the switch is pressed. Selecting Latch will cause NOTE ON to be transmitted on the downward push. The button will stay lit when released. When pressed again and released, NOTE OFF will be transmitted on the upward release action.

### **SCRIBBLE**

Click on for a pop-up to enter an appropriate electronic scribble name which will appear on the display to the side of the associated switch. Either click on a name in the list or click on NEW ENTRY and then use the QWERTY keyboard to type in a new name of up to 6 characters. Then click on OK or press **ENTER** .

### 7-9-3 MIDI Bars & Beats

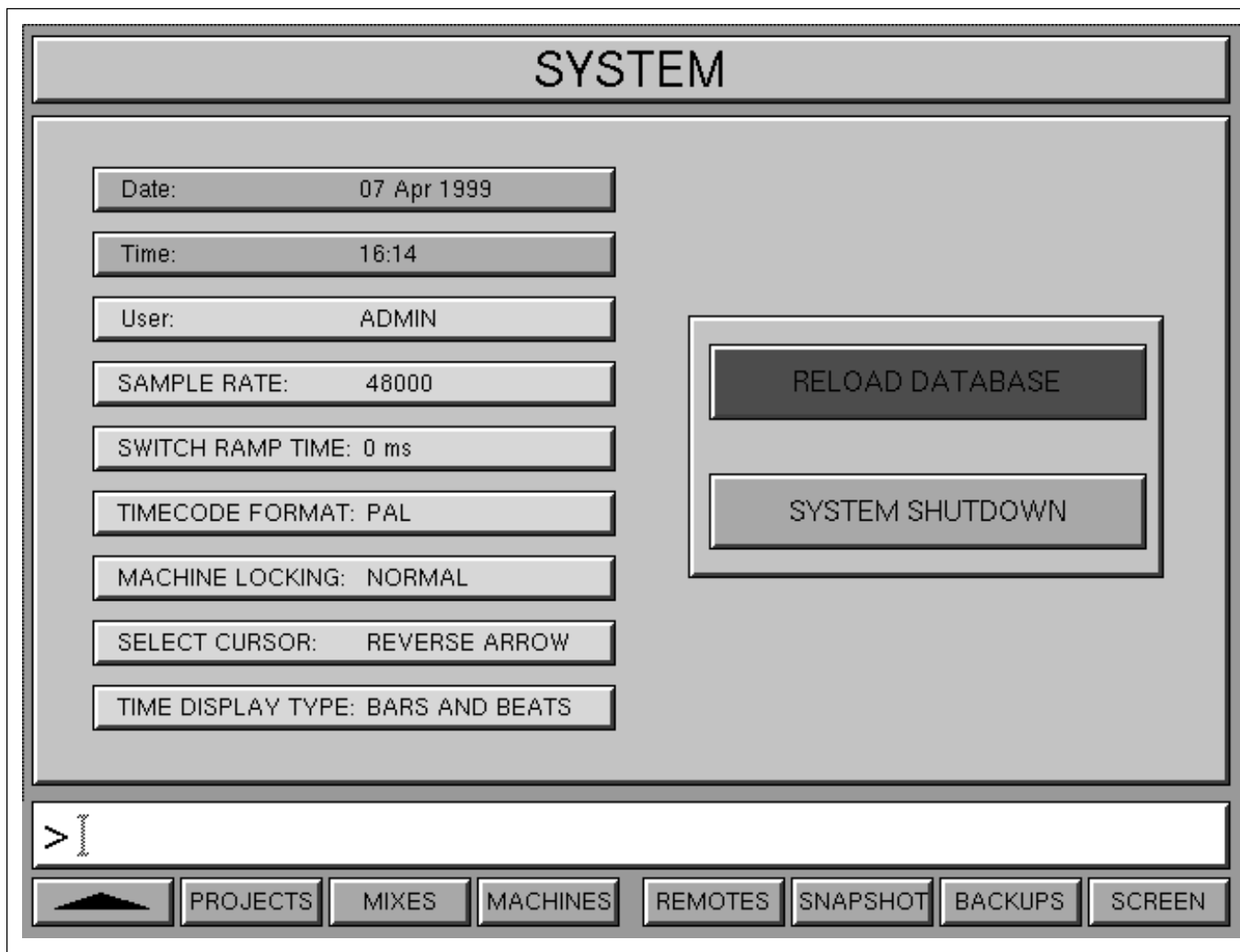

SYSTEM screen

#### General

Bars and Beats can be displayed in all places where timecode is normally displayed except the start and end times of titles in the Artists/Projects & Titles page.

The system allows up to 9,999 bars to be displayed down to a resolution of 16 beats per bar with 99 ticks per beat.

Bars and Beats tempo maps can be programmed via the ARTISTS/PROJECTS & TITLES GUI or imported from Standard MIDI Files (.MID) via 3.5 inch floppy.

Cue points may be specified in Bars and Beats and the automation will also locate to points typed in as such.

#### Selecting BARS & BEATS

The bar on the System page marked 'TIME DISPLAY TYPE' allows alternate selection of either TIMECODE or BARS & BEATS by clicking to the right of the bar.

When displaying BARS & BEATS, the large time display in the MIXES & CUES GUI has an animated graphic display of the beats, whilst the tape is rolling, depending on the current time signature.

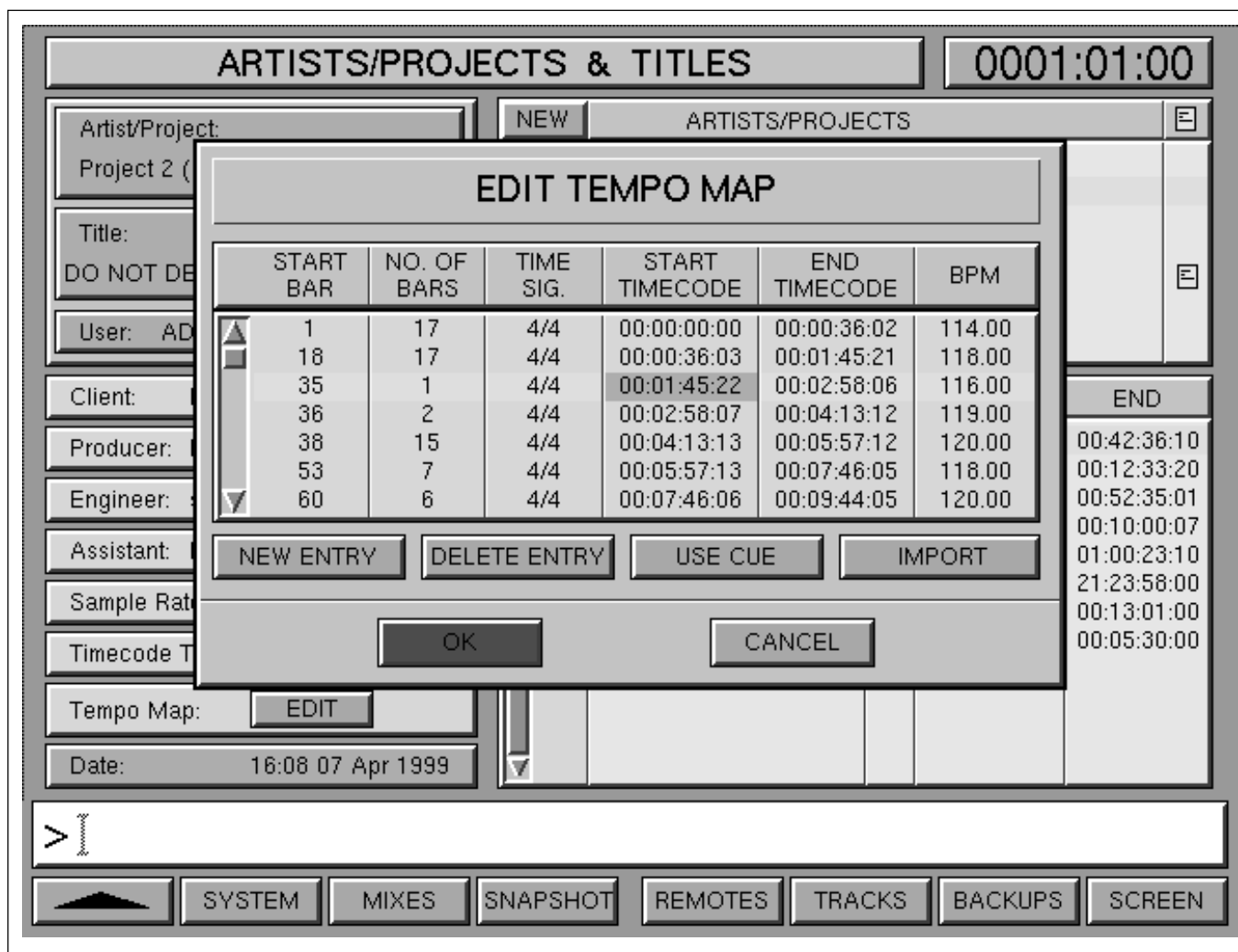

ARTISTS/PROJECTS &amp; TITLES screen displaying EDIT TEMPO MAP pop-up

### Default TEMPO MAP

A default Tempo Map is created automatically when a NEW TITLE is entered. The Tempo Map assumes a single line of default settings as a starting point. The Start and End Times of the Title are used to calculate the number of bars with a default tempo of 120 BPM (Beats Per Minute).

### Editing a TEMPO MAP

To edit a Tempo Map, click on or highlight and press **EDIT** for an entry to display its pop-up. Make changes and then press **ENTER** or click on OK and the other entries will be re-calculated accordingly.

Click on NEW ENTRY to add a new line which may also be edited.

The START TIMECODE and END TIMECODE entries can be specified using the number keys or adjusted using the Jog wheel. To link a time point to a Cue click on USE CUE, which lists the Cues for the current Title, and then click on the one required.

#### Note

If the tape or storage device overruns the boundaries of a Tempo Map, the tempo at the boundaries will continue outside the current map.

### Importing a TEMPO MAP

Insert the 3.5 inch floppy in the host computer drive and click on IMPORT. Once the list of .MID files is displayed, highlight the desired file and click on IMPORT or press **ENTER** on the Control Keyboard. The new imported Tempo Map will appear, replacing any current entries.

# 7-10 Backups

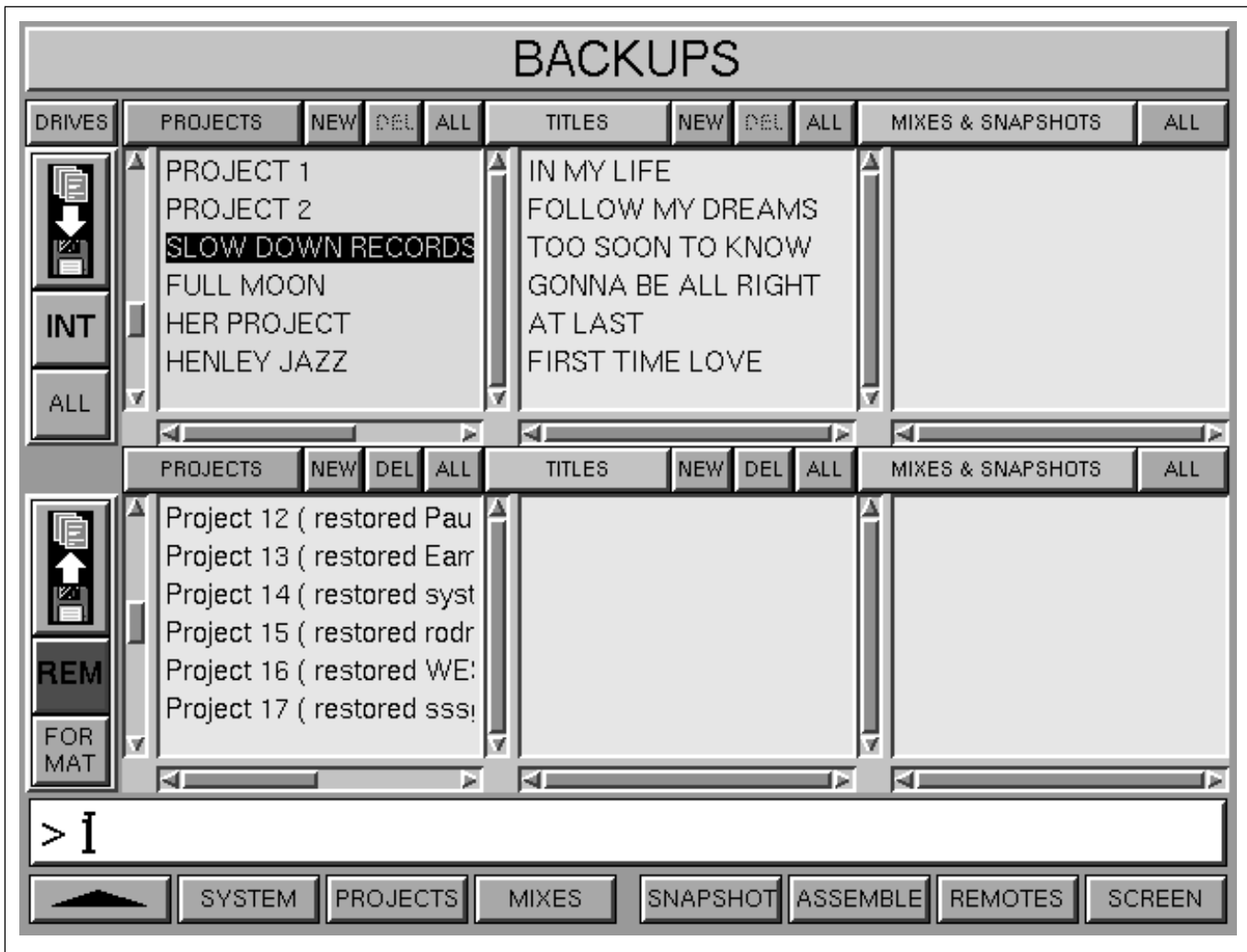

BACKUPS screen

## General

The BACKUPS GUI is designed to allow the user to store work on M.O. disks for archiving and transferring to other systems. A Networking facility is also provided for use where there is more than one OXF-R3 in the same installation.

Work should be backed up at least once per day. It is recommended that backups be taken more often, when a number of projects are being worked on in the same day for example.

This system allows data to be backed up from the internal hard drive to a removable M.O. disk, or vice versa, as well as making copies. All OXF-R3 systems are compatible, allowing projects to be moved freely between installations.

### Layout overview

The BACKUPS GUI primarily consists of two rows of scrolling lists, each with three columns and their own buttons. Either row can select the Internal, Network or Removable drive via a pop-up. The Removable drive must be mounted first before data can be accessed, which will occur automatically when it is selected.

The following description applies to the operation of both drives.

### Columns

The left column displays a list of all Projects on the relevant drive. This allows all Projects to be viewed on both Drives simultaneously. Clicking on the FACTORY legend gives access to further source options:

- **FACTORY SNAPSHOTS**

Basic set-up 'Read Only' Snapshots supplied with the system accessible by User 'ADMIN' only in the Backups GUI.

- **STUDIO SNAPSHOTS**

'Read Only' Snapshots set-up relating to the Studio, accessible by User 'ADMIN' only in the Backups GUI.

- **USERS**

Allows access to Snapshots belonging to the current User. User 'ADMIN' has access to Snapshots belonging to all Users. For ADMIN, the list of Users will be displayed in the left column and Snapshots will be displayed in the middle column depending upon which User is highlighted.

The middle column displays all Titles for a single Project when a single Project is selected. If more than one Project is highlighted then the middle column is blank.

The right column displays all Mixes and Snapshots for a Title when a single Title is selected.

Selecting anything other than exactly one item from a list will clear all lists to the right of the list in question.

### Selection System

Use a Trackerball to select Projects, Titles, Mixes and Snapshots:

- 1 To select individual items click on them one at a time.
- 2 To select a range of items:
  - Click on an item and keep the button pressed, then move the cursor across the desired items to highlight them.
  - Hold down **CTRL** on the QWERTY keyboard and click on the items required one at a time.
  - To select a range, click the first item then hold down **SHIFT** on the QWERTY keyboard and click on the last.
- 3 To select all items in any column, click ALL at the top of the column.
- 4 To de-select a multiple or range just click on a single item.



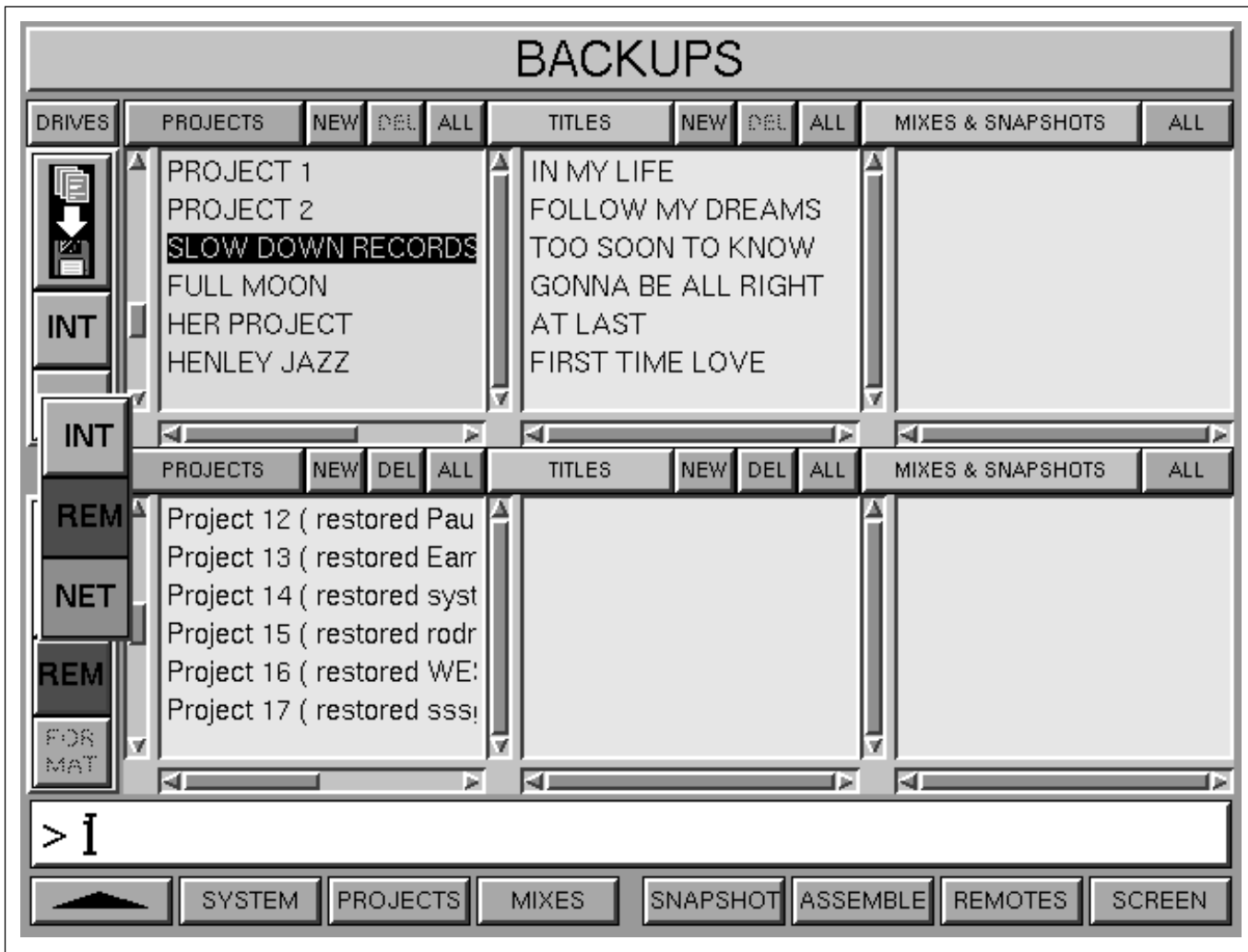

BACKUPS screen displaying the Drives pop-up

### Backup, Restore and Copy operations

A Backup is when the source is the Internal drive and the destination for data is the Removable drive. A Restore constitutes this procedure in reverse. A Copy is when the source and destination are the same drive.

### File names

New projects and titles may be created by clicking on the relevant NEW button. This may be necessary to copy a Mix or Snapshot into a Project but not have placed in a current Titles.

Whenever a files operation occurs, a new item of the correct type is created. Individual files can never be deleted or overwritten using the BACKUPS GUI. For example, a Backup of **My Project** could be named:

#### Project # (backup of My Project)

In other words, the backup has a new name with the original name in (). The # is a unique number which has been assigned automatically. The words in the () will be set according to the operation involved i.e.

**(backup of XXXX)** for a backup operation

(restored XXXX) for a restore operation

(copy of XXXX) for a copy operation

If **Project 12 ( backup of My Project)** is restored, it is likely to be restored with another unique number e.g. **Project 17 ( restored My Project)**. The important point here is that no files can be overwritten and the original name is always there. After any Backup file operation, a pop-up will appear and confirm successful completion.

### DRIVES

Click on DRIVES, upper left, for a pop-up displaying the status of the drives within the system.

#### Note

*This pop-up must be selected in order to eject an M.O. disk in a removable drive.*

### Backup buttons in the GUI

There are three buttons to the left of each row:

#### Upper Icon

This Icon indicates the direction of the data flow, either to the Internal, Removable or Network drive, depending on which drives have been selected in each row. Clicking on the Icon will action the Backup or Copy transaction.

#### Middle button

Click on this for a pop-up allowing the selection of INT(ernal), REM(ovable) or NET(work) drives. Click on one and its files are displayed accordingly.

#### Lower button

The function of this button changes according to the drive selected using the middle button:

Internal drive	• <b>ALL</b>
Removable	• <b>FORMAT</b>

#### ALL button

Clicking on ALL causes a Backup to be made of All the files on the Internal drive.

#### FORMAT button

Click on FORMAT to Format the M.O. disk in the Removable drive.

#### Note

- 1 The ALL operation replaces all data on the Removable drive.*
- 2 The FORMAT operation erases all data. Any files on the M.O. will be lost. A warning is given which requires confirmation.*

### DELETE

The Delete function for Projects and Titles is operable for the M.O. drive only.

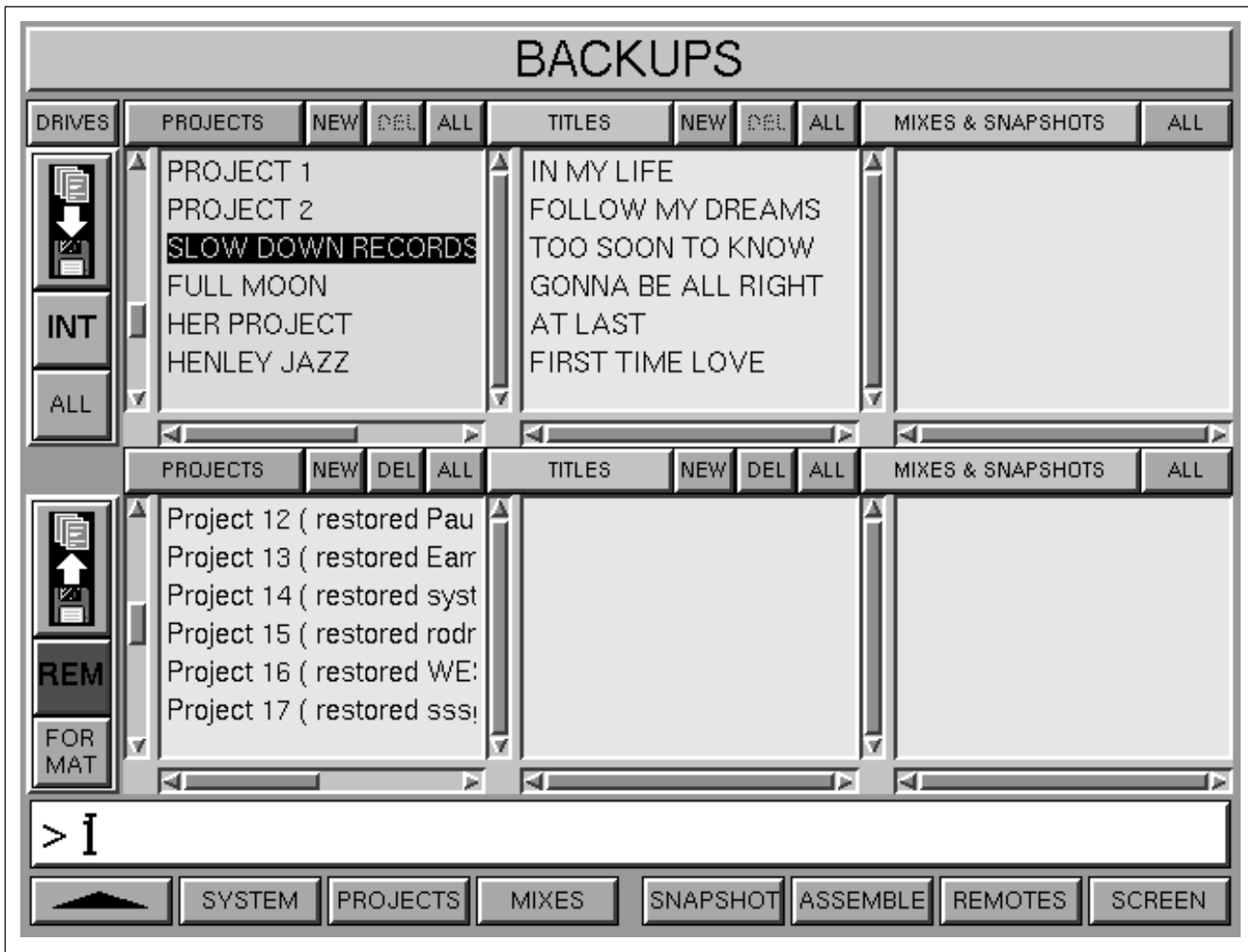

BACKUPS screen

### Backup, Restore and Copy procedure

This procedure applies to specified files.

#### Note

- 1 If a Backup is being made to the Removable drive, make sure an M.O. disk is inserted and that the drive itself is Mounted.
- 2 It is important to remember that if a Mix, Title or Snapshot is to be copied, the destination must have already been created i.e. a copy of a Title must have a suitable Project available and a Mix requires a Project and a Title. Click on NEW to create a PROJECT or TITLE.

- 1 Select the desired drives at the left side of the two rows.
- 2 Click on the desired source files. Any selection that has subordinate files, such as a Title with Mixes, will have all such files copied. The background at the level to be copied will be highlighted so that the user is aware of exactly what will be copied.

- 3** Click on the desired destination file. Again, the background will be highlighted in the destination file area to make the user aware.
- 4** Click on the Icon on the left side of the source row to action the Copy. If, for any reason, the transaction cannot be completed, a pop-up will appear explaining why.

### Note

- 1 *Whilst the Copy is in operation, an ABORT button appears in the left hand column between the drive buttons. Click on this ABORT button to stop the operation. (Note: ABORT is also available during the FORMAT operation).*
- 2 *Whilst Backup operations are taking place, a pop-up gives details of the operation and its progress.*

### Command Dialogue

At the base of the screen, the User Command Dialogue Line bar displays commands from the dedicated Control Keyboard and QWERTY Keyboard for confirmation before **ENTER** .

### Menu options

Menu options available using the softkey functions displayed at the foot of the Backups screen page are as follows:

- ▲** - Selects the previous screen page.
- SYSTEM** - Selects the SYSTEM screen page directly.
- PROJECTS** - Selects the ARTISTS/PROJECTS & TITLES page.
- MIXES** - Selects MIXES & CUES page.
- SNAPSHOT** - Selects the SNAPSHOTS, COPY & LINK page.
- ASSEMBLE** - Selects the mix compilation MERGE/ ASSEMBLE page.
- REMOTES** - Selects the MACHINE REMOTES assignments matrix.
- SCREEN** - Selects pop-up showing all available screen selections. Click on any one to select it.

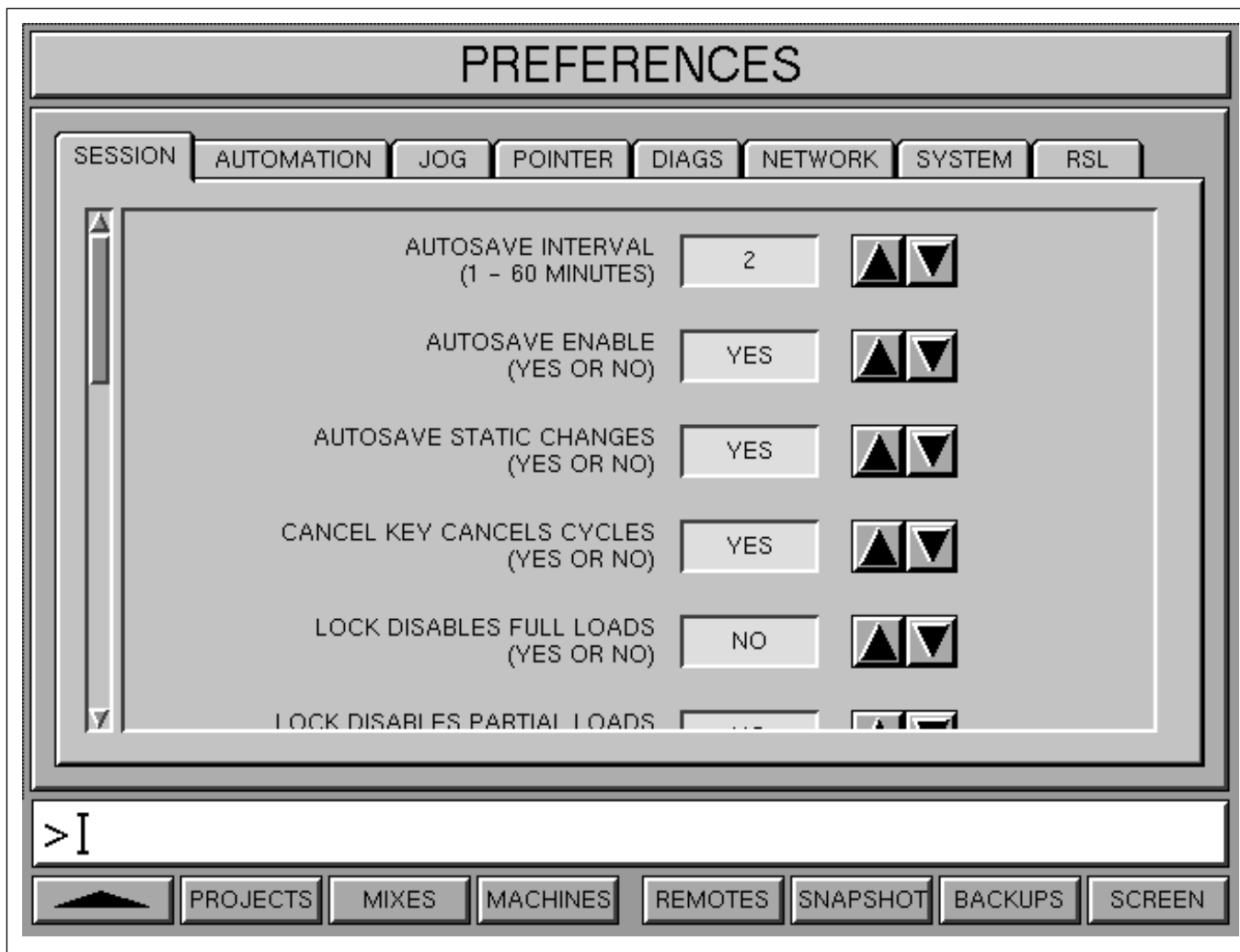

PREFERENCES screen

### General

The PREFERENCES GUI gives access to a number of options available previously in the system 'config file'. To access this GUI, press the softkey below SCREEN at the right hand side of the central LCD. A pop-up list will appear. Use the  $\uparrow \geq$  on the Control Keyboard to highlight PREFERENCES and **ENTER**.

To access a preference, move the cursor over the appropriate tab in the upper part of the GUI using a Trackerball. Click on the tab using the 'activate' button by the Trackerball.

Preferences are changed by clicking on the  $\blacktriangle$  and  $\blacktriangledown$  arrows. Where a YES/NO decision is required, clicking on either will change the setting whereas numbers are incremented and decremented according to the direction of the symbols.

Each entry line in the GUI has a DEFAULT button which is only displayed when other than the default has been selected. Click on this to obtain the system default setting.

### SESSION Tab

#### AUTOSAVE INTERVAL

- Sets the interval, from 1 to 60 minutes, between Autosaves of the working mix. Saves will occur only if there is new data which has not been saved.

#### AUTOSAVE ENABLE

- Allows Autosave to be turned on or off.

#### AUTOSAVE STATIC CHANGES

- Allows Autosave to be triggered to Autosave static non-automated changes.

#### CANCEL KEY CANCELS CYCLES

- Allows the system to be set so that **CANCEL** on the Control Keyboard cancels machine cycle commands.

#### **Note:**

*The following LOCK Preferences refer to the **LOCK** push-button on the Monitor panel in the centre section. When **LOCK** is on, a number of functions can be locked out of operation. These are useful safety settings in live and broadcast situations where the loading of Automation and/or Snapshot data could overwrite a critical console set-up.*

#### LOCK DISABLES FULL LOAD

- Disables the Loading of Full console-wide Snapshots and Mixes.

#### LOCK DISABLES PARTIAL LOADS

- Disables the Loading of Partial Snapshots and Mixes which would affect less than the full console.

#### LOCK DISABLES COPIES

- Disables the Copying of settings from a source channel to one or more other channels.

#### LOCK DISABLES NEW LINKS

- Disables the channel Link set-up mechanism but leaves channels already linked intact.

#### LOCK DISABLES MAKE STATIC

- Disables the **MAKE STATIC** key on the Control Keyboard which normally removes automation from the working mix.

#### LOCK DISABLES OFFLINE OPS

- Disables all Offline operations whether GUI or keyboard entry.

#### VPANEL ENABLE

- Enables transport control via GPIO from an external panel or virtual panel.

**VPANEL IS MACHINE CONTROLLER**

- Sets the external or virtual panel as the master machine remotes in control of the R3 and Motionworker or 9-P control.

**SHOW REMOTES FRAMES**

- Sets the TC display by the transport remotes to display frames.

**TRACK ARMING USES GPIO**

- Sets Record Ready buttons, one above each channel fader, to control the GPIO record relays and display the state of tally inputs. The GPIO card will be installed in one of the I/O racks.
- Selecting NO for this option will cause the Record Ready buttons to operate on whichever machine control interface is currently in use.

**TRACK ARMING FORCES INPUT - 9 PIN ONLY**

- Switches tracks into input mode automatically when they are record enabled.

**LOCK DISABLES SHUTDOWN**

- Prevents display of the SYSTEM SHUTDOWN pop-up and related command.

**LOCK DISABLES NESTED GROUPS**

- This relates to the Control Group Faders 1-32. It prevents the setting up or alteration to nested Control Groups since this could cause jumps in level.

**AUTOMATION Tab****PLAYBACK WHEN MASTER LOCKED**

- Allows playback of automation data with just the master machine locked to the system. In other words, there is no delay waiting for slave machines to become synchronised.

**Note:**

*The following MUTE Preferences relate to elements which may be set to mute during partial loading of Snapshots and Mixes preventing any signals being fed to busses during the load operation. This may be desirable when the new data will load a significantly different set-up to the current one.*

**MUTE CHANNELS ON LOAD**

- Mutes the Channel Outputs for the channels affected by the loading of a Snapshot or Mix.

**MUTE CH MTSENDS ON LOAD**

- Mutes the Channel Multitrack Sends for the channels affected by the loading of a Snapshot or Mix.

**MUTE CHAN INPUTS ON LOAD**

- Mutes the Channel Inputs for the channels affected by the loading of a Snapshot or Mix.

### **MUTE CHAN SENDS ON LOAD**

- Mutes the Channel Sends for the channels affected by the loading of a Snapshot or Mix.

### **MUTE ON FULL LOADS**

- Mutes Channel Outputs, Multitrack Sends, Inputs and Sends for all channels during the loading of a full Snapshot or Mix, according to the individual options selected above.

### **TO TOP ON DROP IN**

- With the TO TOP button on, any controls dropped in to automation write in Abs or Trim will have their settings propagated to the Start Time or 'top' of the Title, from the point of drop in.
- Selecting NO for this option will cause settings to be propagated from the point of dropping out.

### **JOG Tab**

#### **ROTATIONAL SENSE**

- Sets the rotational direction of Jog Wheel:
  - 0 - suitable for digital machines
  - 1 - analogue tape machines, where it follows the direction of tape spools.

#### **DEFAULT MODE**

- Sets the mode for the Jog Wheel when the system is booted:
  - 0 = Off
  - 1 = Jog Mode
  - 2 = Crawl Mode
  - 3 = Shuttle Mode
  - 4 = Data (+/-) Entry Mode

#### **JOG TRIGGER**

- Sets the sensitivity to movement for Jog mode, 1 being the most sensitive and 100 being the least sensitive.

#### **JOG SPEED**

- Sets the ratio of Jog Wheel rotation against that of the machine for Jog mode. The 1 setting gives the finest control and 15 is coarse.

#### **CRAWL TRIGGER**

- Sets the sensitivity to movement for Crawl mode, 1 being the most sensitive and 20 being the least sensitive.

#### **CRAWL SPEED**

- Sets the ratio of Jog Wheel rotation against that of the machine for Crawl mode. The 1 setting gives the finest control and 20 is coarse.



---

## USE LOCATES FOR JOGGING

- Sets an alternative method for jogging remote machines. In this mode the JOG SPEED preference is ignored and the JOG TRIGGER has an increased effect on the sensitivity of the Jog Wheel.

## POINTER Tab

### INDEPENDENT TRACKERBALLS

- Sets the two Trackerballs to operate independently. The left Trackerball controls the cursor or pointer in the 3 LCDs on the left of the console whilst the right controls the 3 LCDs on the right plus the central LCD.

Pressing **SELECT** under the central LCD will put its cursor control under the right Trackerball. The left Trackerball cursor can be moved into the central LCD too, but by manual control only. This allows either or both Trackerballs to control the central LCD cursor. If both Trackerballs are controlling the central LCD then the last one moved takes precedence.

### TRACKERBALL SPEED

- Sets the gearing ratio of the Trackerball movement to cursor movement, 1 being the slowest and 8 the fastest.

## DIAGS Tab

### PRINT TIMECODE WARNINGS TO GUI

- Displays Timecode error messages, such as drop-outs, on the centre LCD.

### SHOW TIMECODE GLITCHES

- Displays non-contiguous or jumps in Timecode.

### NETWORK Tab

The NETWORK function allows other R3 systems, which are on the same 'computer network', to be assigned as remote drives that can be accessed via the Backups GUI. This allows data in the form of Projects and/or associated lower level data, such as Titles, Mixes and Snapshots, to be copied from an external system.

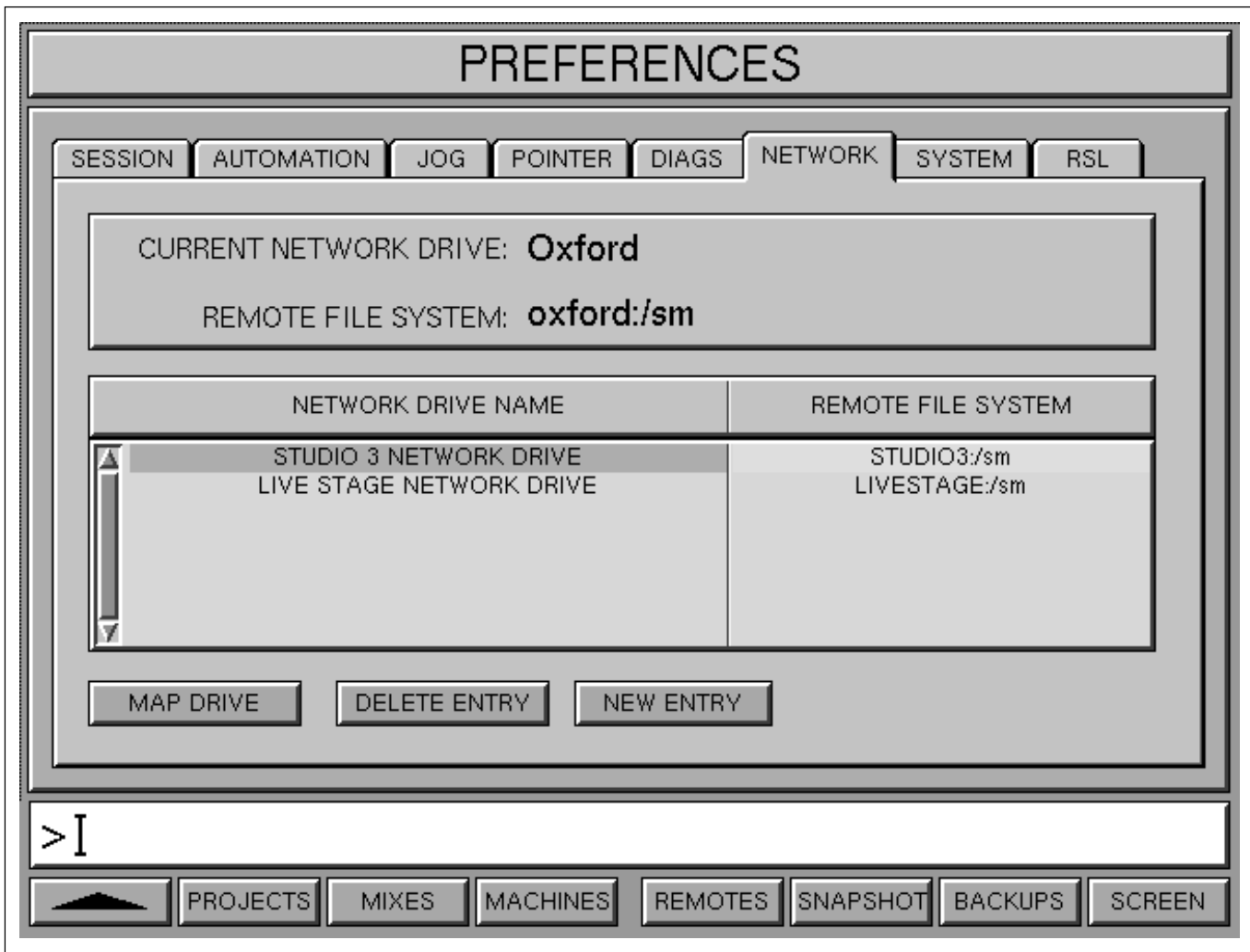

NETWORK ADMINISTRATION screen

### Setting up a NETWORK DRIVE

Each networked drive requires a suitable name along with the name of the host computer relating to the network itself.

- 1 Click on NEW ENTRY for a pop-up to enter a suitably familiar name relating to the remote system. Type it in using the QWERTY Keyboard and then click on OK or **(ENTER)**.
- 2 Move the orange highlight in the same row to the REMOTE FILE SYSTEM column. Click on it or press **(EDIT)** on the Control Keyboard for a pop-up. Enter the host name and file path, which normally ends '/sm' for the remote host computer.

---

Type it in using the QWERTY Keyboard and then click on OK or **ENTER**.

- 3** Click on MAP DRIVE for the local system to make the connection to the remote system. Once completed, a pop-up will appear for confirmation.
- 4** Select the Backups GUI using the appropriate softkey at the foot of the GUI in order to copy files from the remote system.

## **SYSTEM Tab**

### **DETECT POWER FAILURE**

- Sets the OXF-R3 to react to Power Failure messages according to the settings in the Uninterruptable Power Supply (UPS) management software. The R3 can react in one of two ways according to priority levels set within the software.

Lower priority functions can display a warning message on the central GUI according to a script in the UPS software. Higher priority levels, when power capacity is very low, for example, can instigate an immediate Save of Mix Data. In this case, no warning will be given, but a pop-up will confirm the save after the event. A new entry will appear in the Mixes GUI, 'UPS EMERGENCY SAVE'.

## RSL (Remote Studio Link) Tab

The RSL facility allows control linking between two OXF-R3 systems in order to allow collaboration between two locations, which could be anywhere in the world, so long as an ISDN link is feasible. A simultaneous two way link allows changes at either end to affect the audio mix, automation and machine control at the other.

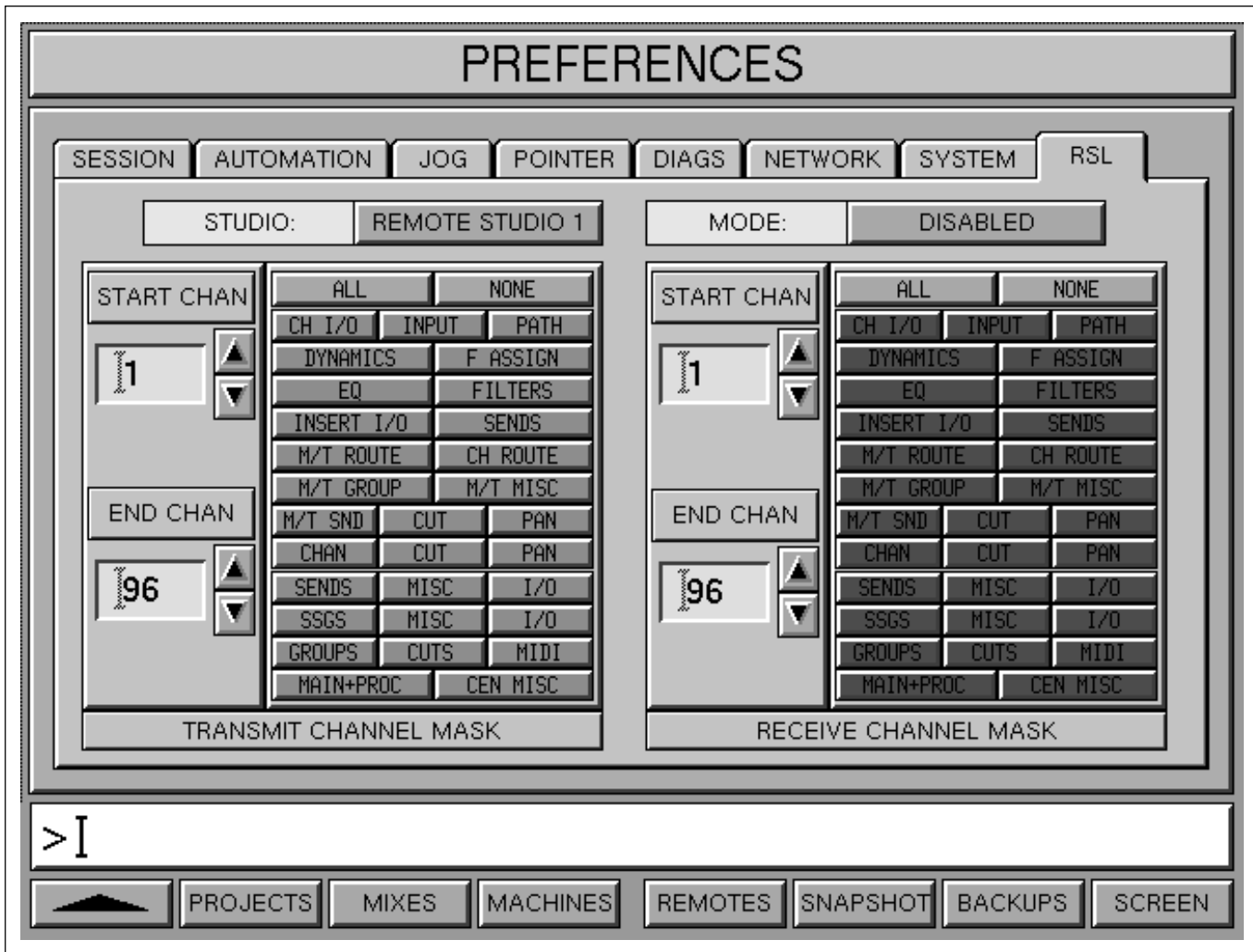

RSL (Remote Studio Link) screen

### General

The operation of RSL involves one studio, which will be called the Primary System (P-S), in running the source material from a multitrack system on tape or hard disc system. The mix can be monitored locally and must be fed to the remote studio, or Secondary System (S-S), via a high quality external audio communications system.

The two way control link, via ISDN, will cause the settings in the P-S to be mapped exactly to the remote S-S. The current title on the P-S will appear in the titles list on the S-S, along with its cues. All the transport commands, such as PLAY TITLE, PLAY CUE, Quick Rollback, work as normal on the S-S. Automation moves in the P-S will be displayed on the S-S. New automation settings can be created on the S-S using Audition

Mode. The new S-S settings will be visible on the P-S but can only be written using the P-S. Set-up via an ISDN line allows near real-time operation for the S-S.

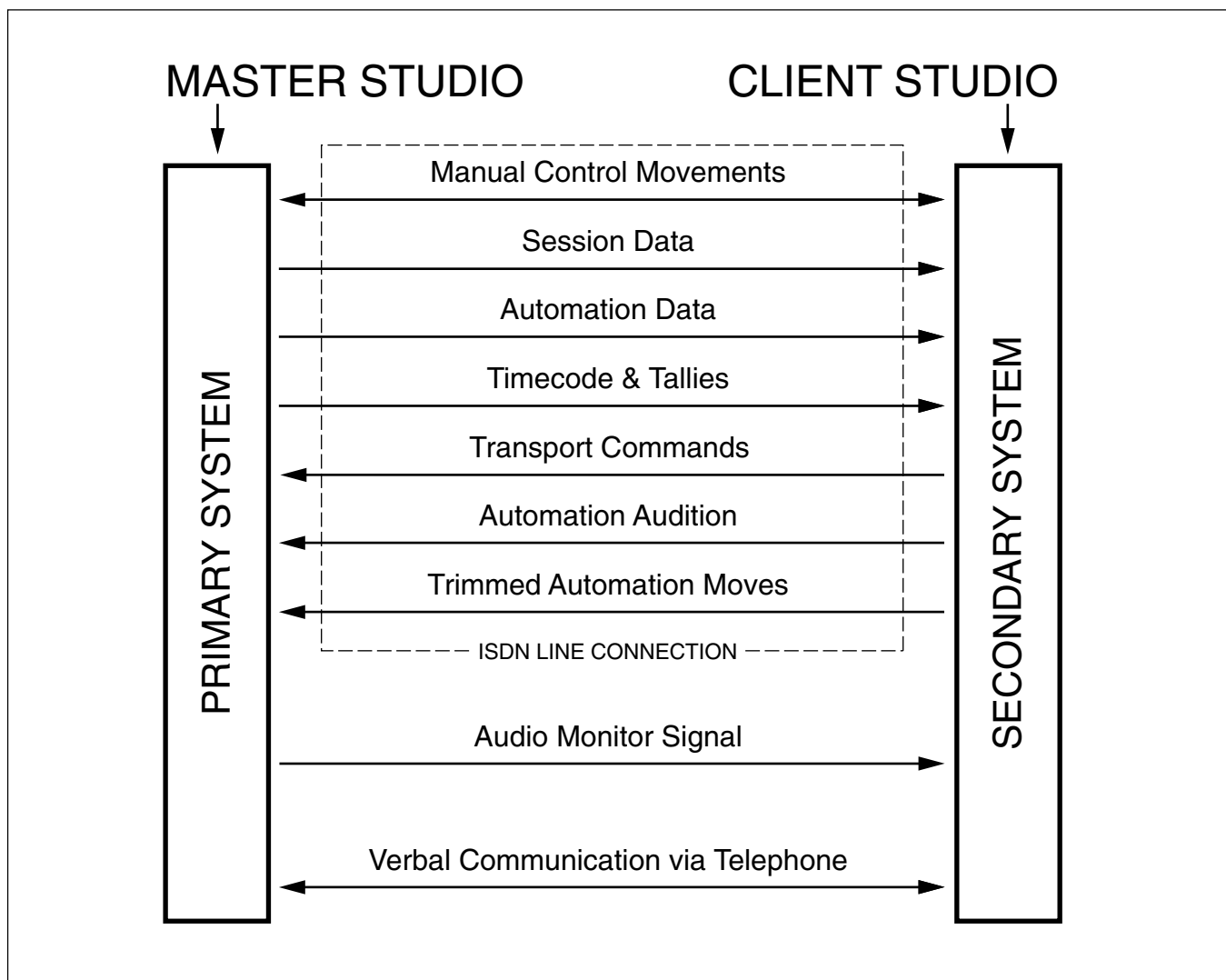

Overview of RSL connections

### RSL Set-up GUI

The set-up procedure applies to both the P-S and the S-S and the set-ups at each end do not need to match. It may be that the P-S will send lots of data in order that the S-S can monitor a full mix, whilst the S-S returns data for just a few important channels.

**Note:**

*The instructions that follow apply for systems set up for RSL. The set-up configuration requires help from Sony Support Personnel.*

### Data sent from the Primary System

- 1 Click on the button to the right of the STUDIO legend for a pop-down listing 4 remote locations. Click on the one that is required.

- 2** Click on the button to the right of the MODE legend to set the status of the local OXF-R3, which can be the Master, Client or Disabled. The local system will then seek and set up appropriate communications.
- 3** In the TRANSMIT CHANNEL MASK section, select the range of channels that data will be transmitted from for the local system. Set the START CHAN and the END CHAN, by clicking on the ▲ and ▼ arrows.
- 4** A further option in the TRANSMIT CHANNEL MASK field at the left, allows individual channel and centre section components to be specified. Clicking on ALL will highlight every component whilst clicking on NONE will de-select them all. They can also be selected individually, turning them on or off, from either starting point.
- 5** In the RECEIVE CHANNEL MASK section, select the range of channels that data will be received from for the remote system. Set the START CHAN and the END CHAN, by clicking on the ▲ and ▼ arrows.

### Command Dialogue

At the base of the screen, the User Command Dialogue Line bar displays commands from the dedicated Control Keyboard and QWERTY Keyboard for confirmation before ENTER.

### Menu options

Menu options available using the softkey functions displayed at the foot of the Network Administration screen page are as follows:

- |          |   |  |
|----------|---|--|
| ▲        | - | Selects the previous screen page.  |
| PROJECTS | - | Selects the ARTISTS/PROJECTS & TITLES page directly.                                   |
| MIXES    | - | Selects the MIXES & CUES page for all mixing functions.                                |
| MACHINES | - | Selects the MACHINES set-up parameters page.   |
| REMOTES  | - | Selects the MACHINE REMOTES assignment matrix.   |
| SNAPSHOT | - | Selects the SNAPSHOTS, COPY & LINK page.   |
| BACKUPS  | - | Selects system BACKUPS functions.  |
| SCREEN   | - | Selects pop-up showing all available screen selections. Click on any one to select it. |

# Appendixes

<b>Software Installation/Upgrades .....</b>	<b>A-2</b>
<b>Multi-Format LS Calibration .....</b>	<b>A-3</b>
<b>Specifications .....</b>	<b>A-6</b>
<b>OXF-R3 Diagnostics .....</b>	<b>A-19</b>
<b>Index .....</b>	<b>I-1</b>

## General

### **Software Installation**

Please refer to the Software Installation Procedure supplied with the release package. Since Sony is constantly simplifying and improving the ease of installation of software, publication of a single and fixed procedure in the Operation Manual is inappropriate.

### **Release Notes**

Please refer to the Release Notes supplied with software releases, particularly those relating to interim upgrades, for details of new features and functional enhancements.





# Multi-Format LS Calibration

The following procedure assumes that the necessary equipment, such as a test set with a precision pink noise generator and reference calibration microphone, is available and connected to the system. Further, that all monitor amplifier input levels are set to known and fixed settings.

## General

The calibration function for multi-channel LS allows trimming LS outputs as follows:

- **Overall tandem trim of +/- 20dB for all LS**
- **Individual trims of +/- 10dB for each LS**

Normal rotation of the knobs gives a fine resolution multi-turn adjustment. Push and turn knobs for coarse adjustment.

# Multi-Format LS Calibration

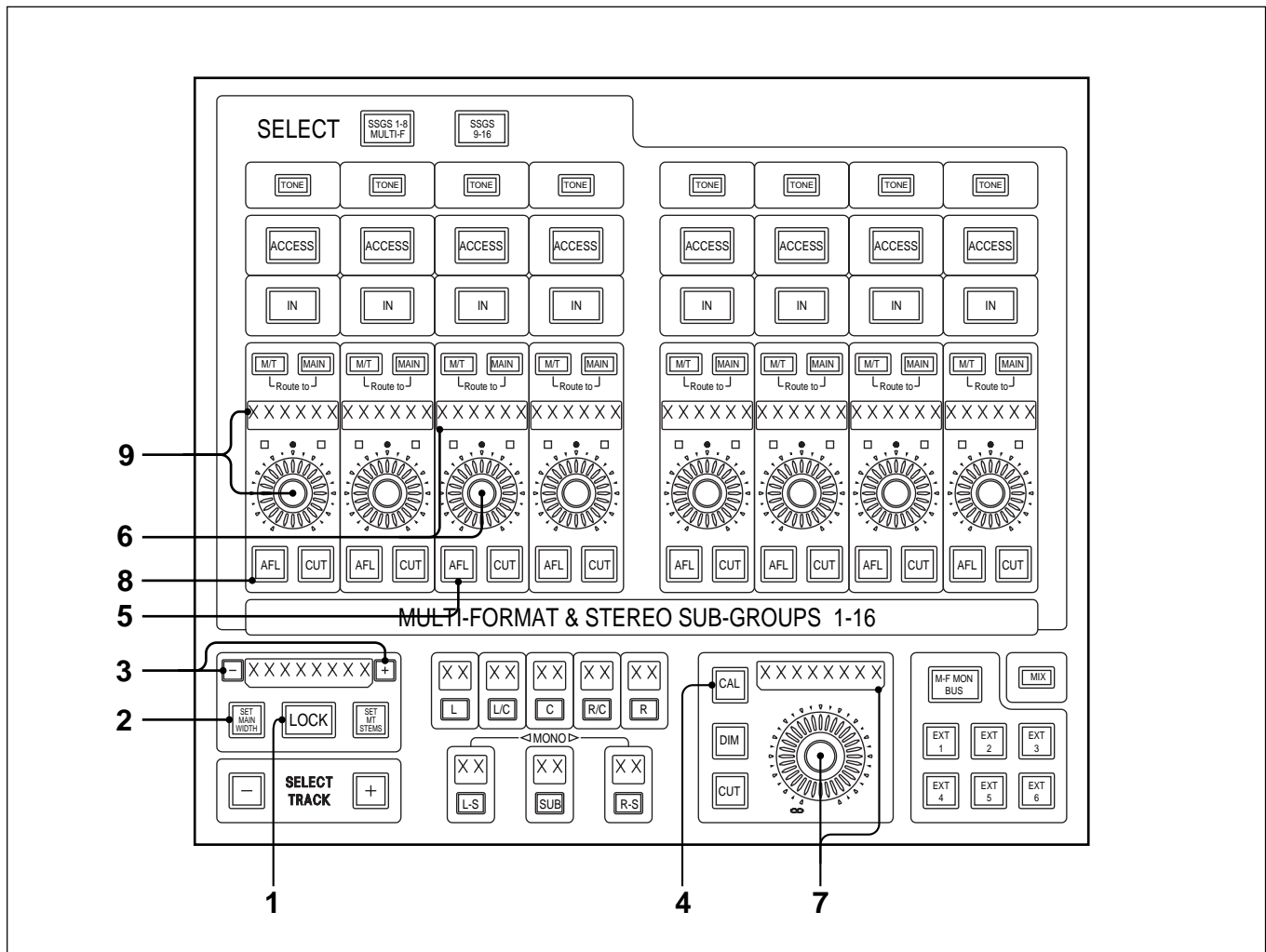

## Calibration Procedure

The following calibration procedure should be carried out for each format. The settings are stored with the system.

Before calibration can begin, make sure 'CAL MODE' is set to ON in the PREFERENCES GUI found on the channel LCDs.

- 1** Press **LOCK** to unlock and its light goes off. It is linked to the set-up buttons and times out 10 seconds after the last button press.
- 2** Whilst unlocked, select **SET MAIN WIDTH** and it lights.
- 3** Whilst unlocked, select the desired format such that it includes all the LS outputs that need calibration.
- 4** Whilst unlocked, press and hold **CAL** until it starts to flash. At the same instant, all knobs and displays enter set-up mode automatically.
- 5** Select the **AFL** (solo) for the centre LS.

- 
- 6** Adjust the trim for the centre LS to read 0.0dB in its associated dot character display.
  - 7** Adjust the overall trim, which trims all LS in tandem, until the measuring equipment reads the required reference level. Its calibration setting will be reflected in its dot character display. The calibration for the centre LS is complete for the first format chosen.
  - 8** Solo another LS using its **[AFL]** button.
  - 9** Adjust its trim until the measuring equipment reads the correct level.
  - 10** Repeat 8 and 9 for the remaining LS for the current format.
  - 11** Repeat the whole procedure for other formats.

## General

### Performance and Temperature Range

Operation of the complete system to performance specification guaranteed 10° C to 35° C. Operation guaranteed from 5° C to 40° C.

### AC Input Power Requirements

#### Control Panel OXF-CP3048

AC100-240V~ 50/60Hz 500W 7.5A×2

#### SP Rack OXF-SP3000

USA/Canada:	AC120V~	50/60Hz	750W 10A
Other destinations:	AC220-240V~	50/60Hz	700W 5A

#### I/O Rack OXF-IO3000

USA/Canada:	AC120V~	50/60Hz	240W 3A
Other destinations:	AC220-240V~	50/60Hz	240W 2A

### Session Management™ System

- Control and storage of data for Projects, Titles, Mixes, Snapshots & Cue points.
- Fully integrated dynamic automation including machine control.
- Mix and set-up data easily transferred between systems.

### Analogue I/O (2 Types - 4 or 8 channels per module)

- 4 ADCs per module with separate Mic & Line inputs.
- 8 ADCs per module with single combined Mic/Line inputs.
- 4 DACs per module ideal for monitor output.
- 8 DACs per module ideal for line output.

### Digital I/O

- MADI, connected directly to the SP Rack.
- AES/EBU, 4 stereo inputs and outputs per module.
- SDIF-2 (24)
- Timecode, 9-Pin and Dash REC Ready.

---

## General

### Features & Functionality

There are two versions of the OXF-R3. They are both operable from the 24-C-24 or the 24-C-0 control surfaces. However their hardware requirements and I/O capabilities are different. The following comparison table summarises the features, functionality and hardware requirements of the two versions.

<b>Features</b>	<b>DMSK-R3096 - 96Ch</b>	<b>DMSK-R3072 - 96Ch</b>
<b>Control Surface Configuration</b>	<b>24-C-24 &amp; 24-C-0</b>	<b>24-C-24 &amp; 24-C-0</b>
<b>Signal Processor Rack</b>		
• Signal Processor Cards	• 16	• 9
• SPLink I/O Interface Cards	• 4 Maximum	• 3 Maximum
• DMCC Memory (Host)	• 512MB Minimum	• 512MB Minimum
<b>I/O Maximum Capacities</b>		
• Mono Analogue Inputs - ADCs	• 312	• 200
• Mono Analogue Outputs - DACs	• 312	• 200
• Mono Digital Inputs - AES	• 312	• 200
• Mono Digital Outputs - AES	• 80	• 80
<b>Mono Channels</b>	<b>• 96 Channels</b>	<b>• 96 Channels</b>
• Inputs	• Mic, Multitrack & Line	• Mic, Multitrack & Line
• Channel Path Set-up	• 8 Pick-n-Mix Processing Elements	• 8 Pick-n-Mix Processing Elements
• EQ * DMSK-R3001 GML Option	• 5 Band Parametric • 4 Curve Characteristic Variations • GML 8200 EQ Plugin Option	• 5 Band Parametric • 4 Curve Characteristic Variations
• High & Low Pass Filters	• 6 Slopes, 6-36dB/Octave	• 2 Slopes, 6 & 12dB/Octave
• Dynamics * DMSK-R3001 GML Option	• Gate • Expander • Compressor • Limiter • 3 Compressor Characteristic Types • GML 8900 Dynamics Plugin Opt. • 2 Band Parametric Side-Chain EQ Can be used in Channel Path • Side Chain Link To & From Right • 4 Side Chain Busses	• Gate  • Compressor/Limiter  • 3 Compressor Characteristic Types  • Side Chain Link To & From Right
• Post M/T Fader Direct Outputs	• 96	-
• Insertion Points	• 1 Insert	• 1 Insert
• Delay Control	• 0 - 1.2 Seconds (@48 kHz)	• 0 - 0.6 Seconds (@48 kHz)
• Panning	• Stereo - 7.1 Surround	• Stereo - 7.1 Surround
<b>Mono Return Channels</b>	<b>• 24 Channels</b>	-
• Inputs	• Mic, Multitrack & Line	
• Channel Path Set-up	• 8 Pick-n-Mix Processing Elements	
• EQ	• 2 Band Parametric	
<i>Continued</i>		

# Specifications

Features	DMSK-R3096 - 96Ch	DMSK-R3072 - 96Ch
<b>Mono Return Channels</b> (cont.)	• <b>24 Channels</b>	-
• Dynamics	-	
• Insertion Points	• 1 Insert	
• Delay	• 0 - 1.5 Seconds	
<b>Busses &amp; Outputs</b>		
• Main Output	<ul style="list-style-type: none"> <li>• Stereo, LCRS, 5.1 &amp; 7.1 Bus</li> <li>• 2 Band Parametric EQ</li> <li>• 3 Compressor Characteristic Types</li> <li>• Insert</li> <li>• Envelope Modulator</li> <li>• GML 8900 Dynamics Plugin Opt.</li> </ul>	<ul style="list-style-type: none"> <li>• Stereo, LCRS, 5.1 &amp; 7.1 Bus</li> <li>• 2 Band Parametric EQ</li> <li>• 3 Compressor Characteristic Types</li> <li>• Insert</li> <li>• Envelope Modulator</li> </ul>
• Multitrack Busses	• 48	• 48
• Multitrack Monitor Bus	• Stereo (Used in Broadcast Mode)	
• Send Busses	• 24 Mono, or up to 12 Stereo	• 12 Mono, or up to 6 Stereo
• Super Send Group Busses	• 16, Configurable as Mono, Stereo, LCR, LCRS, 5.0, 5.1, 7.0 & 7.1	• 8, Configurable as Mono, Stereo, LCR, LCRS, 5.0, 5.1, 7.0 & 7.1
<b>Monitor Section</b>		
• Control Room Monitor Outputs	<ul style="list-style-type: none"> <li>• 2 Surround (Up to 7.1)</li> <li>• 1 Stereo</li> <li>• AES Digital Monitor Outputs</li> </ul>	<ul style="list-style-type: none"> <li>• 2 Surround (Up to 7.1)</li> <li>• 1 Stereo</li> </ul>
• Studio LS Outputs	• 2 Stereo	• 2 Stereo
• Foldback Outputs	• 4 Stereo	• 4 Stereo
• External Source Inputs	• 4 x 7.1 Surround, 8 Stereo	• 4 x 7.1 Surround, 8 Stereo
• External Source Switcher	<ul style="list-style-type: none"> <li>• Main Output Bus</li> <li>• External Sources 1-12</li> <li>• Fold-Down Matix Output</li> <li>• Multitrack Monitor Bus</li> </ul>	<ul style="list-style-type: none"> <li>• Main Output Bus</li> <li>• External Sources 1-12</li> <li>• Fold-Down Matix Output</li> </ul>
<b>Oscillators</b>		
• With Level & Frequency Control	• 3	• 1
<b>Machine Control</b>		
• Control of Multiple Machines	• Motionworker Option	• Motionworker Option
• External Control Input	• Timecode Chase	• Timecode Chase

---

## Audio Specifications

**Note:**

1 Wherever dB values are specified, the following conventions apply:

0dBu =	0.775V RMS Reference
0dBm =	1mW (0.775V RMS) into 600Ω
dBfs =	Referenced to Digital Full Scale
dB <sub>r</sub> =	Referenced to Max. Analogue Operating Level
dB =	Referenced to Unity Gain

2 Noise figures are measured with a bandwidth from 20Hz–20kHz.

3 The following specifications apply with FS at 48 kHz and the internal Operating Level set to +20dBu.

4 The measurements apply to a complete OXF-R3 system.

### Sample Rates

44.1 - 48kHz +/- 12.5%

(The OXF-R3 always requires an external BNC audio word clock and will chase a varispeed reference)

## 4 Ch Analogue MIC & LINE Inputs

### Gain Control

- MIC -20dB to +80dB in 1dB steps
- LINE -30dB to +20dB in 1dB steps

### Input Impedance

- MIC 1.5kΩ or 100kΩ switchable
- LINE 16kΩ

### Max Input Level

- MIC 50V @ 50Hz for 1 Minute
- LINE 200V DC–1kHz for 1 Minute

### Noise Floor

- MIC < -124dBfs Equivalent Input Noise (Z<sub>in</sub> = 200Ω, Gain = 80dB)
- LINE < -108dBfs (Gain = 0dB)

### CMRR

- MIC > 45dB 20Hz–20kHz (Gain = 0dB)
- LINE > 50dB 20Hz–20kHz (Gain = 0dB)

### Frequency Response

- 20Hz–20kHz +/- 0.2dB

### Distortion 20Hz–20kHz

- Full Scale Signal < -96dBfs (0.005% THD + N)
- -20dBfs Harmonic content < -115dBfs

## Phantom Power

- 48V for MIC inputs, individually switched from control surface.

## Crosstalk Between Inputs

- 20Hz–20kHz < -90dBfs

## 8 Ch Analogue MIC & LINE Inputs

### Gain Control

- MIC -20dB to 80dB in 1dB steps
- LINE -30dB to +20dB in 1dB steps

### Input Impedance

- MIC < 7k5Ω Balanced
- LINE < 7k5Ω Balanced

### Max Input Level

- MIC 50V @ 50Hz for 1 Minute
- LINE 200V DC–1kHz for 1 Minute

### Noise Floor

- MIC < -124dBfs Equivalent Input Noise (Z<sub>in</sub> = 200Ω, Gain = 80dB)
- LINE < -105dBfs (Gain = 0dB)

### CMRR

- MIC > 45dB 20Hz–20kHz (Gain = 0dB)
- LINE > 50dB 20Hz–20kHz (Gain = 0dB)

### Frequency Response

- 20Hz–20kHz +/- 0.2dB

### Distortion 20Hz–20kHz

- Full Scale Signal: < -96dBfs (0.005% THD + N)
- -50dBfs: < -135dBfs

## Phantom Power

- 48V for MIC inputs, individually switched from control surface.

## Crosstalk Between Inputs

- 20Hz–20kHz < -90dBfs



---

## 4 Ch Analogue LINE Outputs

### Output Type

- Electronic Floating type with performance identical, balanced and unbalanced. Maximum output level +24dBm.

### Equivalent Source Impedance

- 20Hz–20kHz < 10Ω

### Output Balance

- 20Hz–20kHz < 60dB (0.1%)

### Minimum Destination Load

- 300Ω

### Frequency Response

- 48kHz Sample Rate 20Hz–20kHz, +/- 0.2dB

### Output Noise

- < -109dBr

### Distortion 20Hz–20kHz

- -1dBfs: < -96dBfs (0.005% THD+N)
- -50dBfs: < -135dBfs

### Crosstalk Between Outputs

- 20Hz–20kHz < -100dBfs

### Stability

- Unconditional

### Compliance

- +/- 15V

### Short Circuit Tolerance

- Indefinite in all modes

## 8 Ch Analogue LINE Outputs

### Output Type

- Electronic Servo type
- Maximum output level into a balanced load +24dBu
- Maximum output level into an unbalanced load +20dBu

### Equivalent Source Impedance

- 100 $\Omega$

### Output Balance

- 20Hz–20kHz < 46dB (0.5%)

### Minimum Destination Load

- 300 $\Omega$

### Frequency Response

- 48kHz Sample Rate 20Hz–20kHz, +/- 0.2dB

### Output Noise

- < -104 dBfs

### Distortion 20Hz–20kHz

- -1dBfs: < -90dBfs 20Hz–20kHz (0.005% THD+N)
- -50dBfs: < -120dBfs

### Crosstalk Between Outputs

- 20Hz–20kHz < -100 dBfs

---

## System Signal to Noise Performance

Since the internal architecture of the OXF-R3 is 32 bit, with a dynamic range of greater than 190dB in general, the system signal to noise ratio is almost entirely dependent upon the noise performance of its sources. Currently, the conversions from analogue to digital and back are the most critical stages.

The OXF-R3 has two types of converter module, 4 and 8 channel units. The more comprehensive 4 channel type have slightly better performance than the 8 channel units.

Although the gain control resolution is 1dB, the analogue stages are switched in 6dB steps. The 1dB steps are achieved in the digital domain, thereby amplifying the noise of the converter stages accordingly. This means that the greatest dynamic range is achieved where no digital amplification takes place. In practice, the best case noise floor set by any single input will vary depending on its gain setting as follows:

### 4 Ch MIC ADC Source

- Variation from -106dBfs to -112dBfs

### 4 Ch LINE ADC Source

- Variation from -104dBfs to -110dBfs

### 8 Ch ADC MIC or LINE Source

- Variation from -102dBfs to -108dBfs

**Note:**

*The figures above are derived using a single input source. The measurement is taken from a 24 bit digital output.*

# Specifications

## Full Channels Equaliser & Filters

Section	Gain	Frequency	Q/Slope	Overshoot
LF Filter	-6dB Steps	20-500Hz	0 -36dB/Oct	-
LF Peak/Shelf	+/-20dB	20-400Hz	0.5 - 16	0 – 50% (Q adjust in ‘Shelf’)
LMF	+/-20dB	30-600Hz	0.5 - 16	-
MF	+/-20dB	100Hz-6kHz	0.5 - 16	-
HMF	+/-20dB	600Hz-18kHz	0.5 - 16	-
HF Peak/Shelf	+/-20dB	2-20kHz	0.5 - 16	0 – 50% (Q adjust in ‘Shelf’)
HF Filter	-6dB Steps	1-20kHz	0 -36dB/Oct	-

## Return Channels & MAIN Outputs Equaliser

Section	Gain	Frequency	Q/Slope	Overshoot
LF Peak/Shelf	+/-20dB	20-400Hz	0.5 - 16	0 – 50% (Q adjust in ‘Shelf’)
HF Peak/Shelf	+/-20dB	2-20kHz	0.5 - 16	0 – 50% (Q adjust in ‘Shelf’)

## Dynamics

### Dynamics Gain Reduction:

All levels in the table below are referenced to full scale and time constants apply to a 10dB gain change. The time constant marked \* denotes a calculated value for 10dB gain change since the true figure is 40dB gain change in 20.8us (1 sample).

### Full Channels Dynamics

Section	Threshold	Ratio/Range	Attack	Hold	Release
Gate	-80 - 0dB	0 - -80dB	5µs* - 26ms	10ms - 10s	7.8 - 519ms
Expander	-60 - 0dB	0 - -80dB	0.26 - 104ms	10ms - 20s	519µs - 519ms
Compressor	-60 - 0dB	1:1 - Limit	519µs - 52ms	10ms - 30s	52ms - 3.1s
Limiter	-60 - 0dB	-	100µs - 500ms	50ms - 30s	100ms - 10s
Compressor	<b>Gain Make-up</b> 0-24dB		<b>Soft Curves</b> 5dB, 10dB, 15dB, 20dB across Threshold		

### Full Channels Dynamics Side-Chain EQ:

The 2 band side-chain equaliser can be inserted in :

- the Dynamics Side-Chain alone
- the Signal Path alone
- both the Side-Chain and the Signal Path

Section	Gain	Frequency	Q/Slope	Overshoot
LF Peak	+/-20dB	20Hz - 1kHz	0.5 - 16	-
HF Peak	+/-20dB	500Hz - 20kHz	0.5 - 16	-

### Main Outputs Dynamics

Section	Threshold	Ratio/Range	Attack	Hold	Release
Compressor	-60 - 0dB	1:1 - Limit	519 $\mu$ s - 52ms	10mS - 30s	52mS - 3.1s
Compressor	<b>Gain Make-up</b> 0-24dB		<b>Soft Curves</b> 5dB, 10dB, 15dB, 20dB across Threshold		

# Specifications

## I/O Rack System

The I/O system for the OXF-R3 utilises a universal rack design to house both analogue and digital I/O. It may, under certain circumstances, be possible to mix analogue and digital I/O modules in the same rack. Each rack requires AC mains power.

## I/O Rack Modules

Each I/O rack contains:

- 1 x Digital Link Card Module
- Up to 10 Device Card Modules such as ADCs, DACs etc.

I/O Module	Inputs	Outputs	Con. Type	Notes
Digital Link	1 MADI  RS422 General Purpose Port RS232 Diagnostic Port	1 MADI	2 BNC 75Ω (1 Optical) 1 9P-Dsub 1 9P-Dsub	For Connection to SP Rack
Analogue In	4 MIC, 4 Line (Mic & Line inputs cannot be used simultaneously)		8 XLR-3-31	112 dB Dynamic Range
Analogue In	8 MIC/Line		8 XLR-3-31	107 dB Dynamic Range
Analogue Out		4 Line	4 XLR-3-32	110 dB Dynamic Range
Analogue Out		8 Line	8 XLR-3-32	104 dB Dynamic Range
AES/EBU In	4 Stereo	4 Stereo	4 XLR-3-31	
AES/EBU Out	4 Stereo	4 Stereo	4 XLR-3-32	
SDIF-2 (24)	24 Mono	24 Mono	2 50P-Dsub	
TC In	Timecode	Timecode	1 XLR-3-31	
MIDI	In	Out	3 5P-DIN 180° + THRU CON.	
Video Ref	In		1 BNC 75Ω	
Multi Remote Control	REC/RDY tally	READY command	1 100P	
GPI	OPTO In (photo coupler)	Relay Closures	25P-Dsub	Relay & Opto 30V Max. Relay 30mA Max.

## MADI Connections

MADI connections may be made directly to the SP Rack without the need for I/O Racks.

	Inputs	Outputs	Con. Type	Notes
MADI	56	56	2 BNC 75Ω (1 OPTICAL)	Connect Directly to SP Rack

## Maximum I/O Configurations

Below are the maxima for each type of I/O module type per system. It should be noted, however, that the total number of audio connections, whether analogue or digital, should not exceed:

***The Maximum of 448 Inputs and 448 Outputs per System***

I/O Type	Maximum	Maximum Number of Modules by Type
Analogue In	128	32 4-ADC Units, 16 8-ADC Units
Analogue Out	128	32 4-DAC Units, 16 8-DAC Units
AES/EBU In	56 Stereo	4 (Inputs & Outputs on same module)
AES/EBU Out	32 Stereo	4 (Inputs & Outputs on same module)
TC/9P/MIDI/Video	1	1
GPI In/Out	12	1 (Includes 48 Tracks of Dash Record Remotes)
MADI In/Out	112	2 Connections (Direct to SP Rack)

Each I/O Rack can have up to a maximum of 56 Audio Inputs and Outputs, analogue or digital.

## Dimensions & Weight

Equipment	Width	Height	Depth	Weight
24C24 Control Console	2516mm 99.1"	1046mm 41.2"	1215mm 48"	382 kg 842 lb 3 oz
24C0 Control Console	1620mm 63.9"	1046mm 41.2"	1215mm 48"	221 kg 487 lb 4 oz
Signal Processor Rack	480mm 19"	670mm 26.5" (15U)	600mm 23.7"	60 kg 132 lb 4 oz
Analogue Digital I/O Rack	480mm 19"	315mm 12.5" (7U)	455mm 18.0"	25 kg 55 lb 2 oz

# Specifications

## Supplied Accessories

<b>OXF-CP3048: Control Panel</b>		
Power Cable		... x2
Operation Manual		... x1
<b>OXF-SP3000: SP Rack</b>		
PCI I/F Cable		... x1
Power Cable		... x1
<b>OXF-IO3000: I/O Rack</b>		
Power Cable		... x1
<b>DMSK-R3/3096: Digital Console Software</b>		
Software Disk License Agreement		... x1

## Product Identities

Model Number	Model Name
OXF-CP3024	Sony Control Panel
OXF-CP3048	Sony Control Panel
OXF-SP3000	Sony SP Rack
OXF-IO3000	Sony I/O Rack
DMBK-R3001	Sony Mic/Line A/D Converter
DMBK-R3002	Sony Monitor D/A Converter
DMBK-R3003	Sony Line A/D Converter
DMBK-R3004	Sony Line D/A Converter
DMBK-R3005	Sony SP Board
DMBK-R3006	Sony SP Link Board
DMBK-R3007	Sony SDIF-2 I/O Board
DMBK-R3008	Sony AES/EBU D I/O Board
DMBK-R3009	Sony Timecode Board
DMBK-R3010	Sony GPI Control Board
DMBK-R3011	Sony Producer Desk
DMBK-R3012	Sony Speaker Stand
DMSK-R3072	Sony Digital Console Software
DMSK-R3096	Sony Digital Console Software
DMSK-R3001	Sony GML EQ/Dynamics Emulation Software



# OXF-R3 Diagnostics

Operator Diagnostics are not available in this version. The following screen pages are included in the OXF-R3 for the use of Qualified Service Personnel.

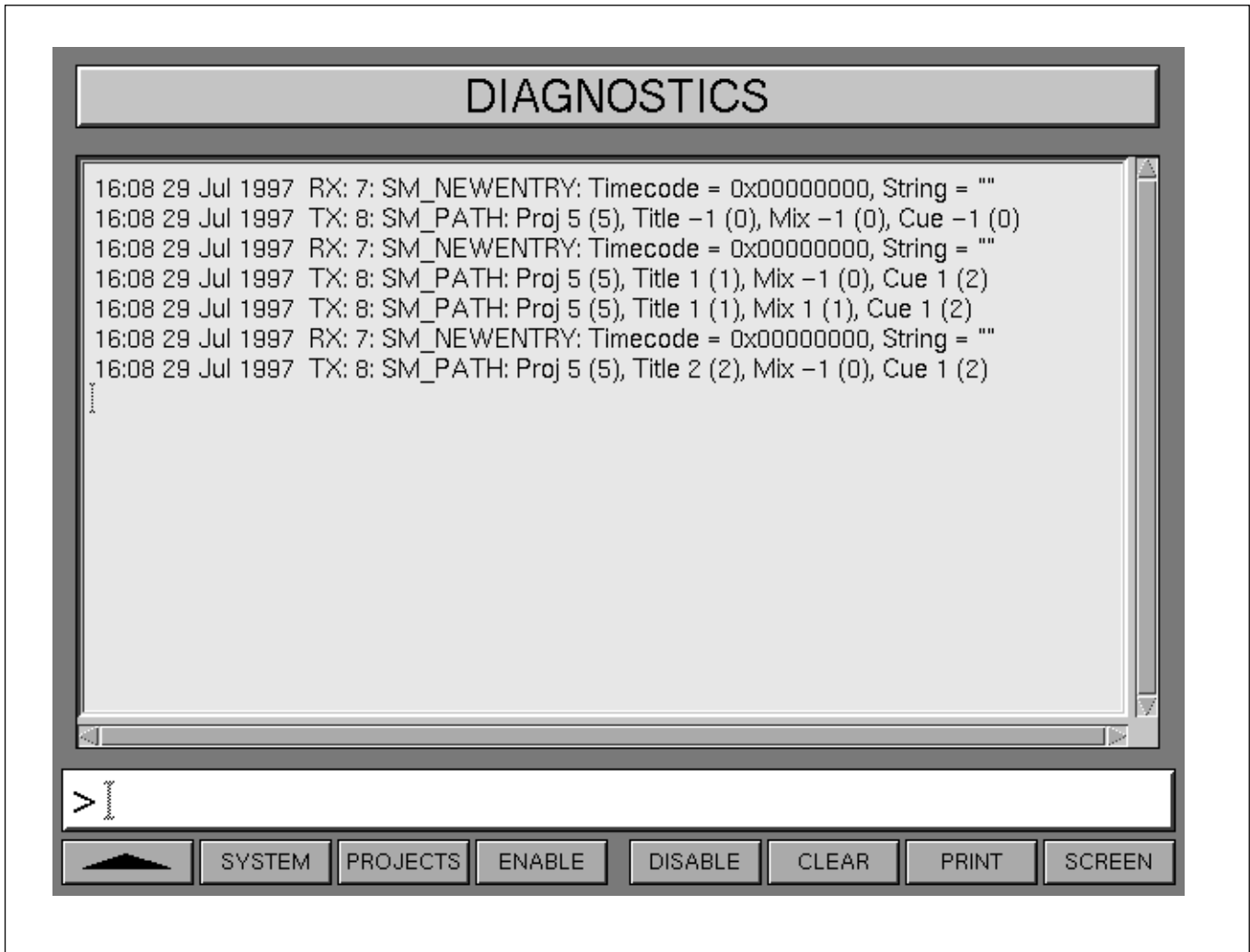

Diagnostics screen page



## A

Ancillary push-button block (lower) 6-58/60  
Ancillary push-button block (upper) 6-55/57  
Artists/projects & titles screen 7-32/34  
Assignable channel processing 3-9  
Assignable panels 3-3, 3-4/5  
Automation off 7-79

## B

Backups screen 7-95  
    backup, restore & copy operations 7-97/98  
    backup, restore & copy procedure 7-99/100  
    layout overview 7-96  
Basic console operations  
    to bounce tracks 3-28  
    to equalise monitor signal post multitrack 3-25  
    to equalise signal feeding the multitrack 3-24  
    to insert dynamics post multitrack return 3-27  
    to insert dynamics pre multitrack send 3-26  
    to link compressor side-chains in a group 3-31  
    to link compressor side-chains so that one channel  
        controls a second channel 3-32  
    to monitor signals to and from tape 3-22  
    to route a mic or line input to the main output bus 3-19  
    to send signals to tracks on tape 3-21  
    to set up a de-esser using dynamics side-chain EQ 3-30  
    to set up a stereo headphone mix 3-23  
    to set up a super send group from channel inputs 3-20  
    to set up super send groups from multitrack 3-29  
Bounce push-button 3-12

## C

Central section faders 6-86  
    control groups and slaves 6-86  
    nested control groups 6-86  
Central section panels 6-38/61  
Channel metering  
    channel meter default 4-15  
    channel meters to input 4-15  
    multi in channel path 4-17  
    return monitor 4-16  
    send monitor 4-16  
Channel screens 5-5  
    channel inserts 5-20  
    dynamics GUI 5-29  
    equaliser & filters GUI 5-28  
    hierarchy (1st level) 5-6  
    hierarchy (2nd & 3rd levels) 5-7  
    I/O GUI 5-11/27  
    line inputs 5-19  
    master GUI 5-39/48  
    mic inputs 5-15  
    multitrack group inserts and outputs 5-25  
    multitrack inputs 5-19  
    preferences GUI 5-30/38  
    routing GUI 5-8

Command lines 6-64/72  
    command key functions 6-65  
    examples 6-65/72  
    function keys 6-64  
    quick rollback 6-73  
    ranges & lists 6-65  
    using numeric keypad to enter timecode 6-73

Control keyboard panel 6-62  
    command lines 6-64/72  
    jog wheel functions 6-63  
    keyboard entry to record arm channel tracks 6-75  
    tape remotes section 6-74/75

Control LCD screen panel 6-87

Control screens  
    master control screens 5-2  
    structure 5-3/4

Control surface  
    assignable panels 3-3, 3-9  
    basic elements 3-3  
    configurations 3-2, 6-3  
    layout 3-6/7, 6-3/5  
    location of assignable panels 3-4/5  
    main areas of operation 3-3

Conventions used in this manual 6

Copy channel fader balance 7-60

Copy monitor and M/T send fader balance 7-60

Cue points  
    to adjust the time of a cue point offline 7-12  
    to obtain a rough balance 7-12  
    to set a cue point offline 7-12  
    to set cue points 'on the fly' 7-11

## Cuts

add a new cut 7-16, 7-73  
advance the in-point 7-17, 7-74  
advance the out-point 7-17, 7-74  
automate cuts 7-13/15, 7-70/75  
erase a cut completely 7-18, 7-75  
make a cut longer 7-18, 7-75  
modify cuts using ready trim 7-73  
set up cuts for automation locally 7-71  
set up cuts for automation using central master keys 7-71

## D

Data flow 1-4/5

Diagnostics screen A-17

Dynamic automation moves  
    automation off 7-79  
    dropping out of write on subsequent mix passes 7-78  
    film mode 7-80  
    global ready enable 7-81  
    motorised fader controls 7-64  
    selective automation isolate 7-79  
    to automate a pan move (or any other knob) 7-77  
    to automate cuts 7-70/75  
    to automate other switches 7-76  
    to trim pan moves (or any other knob) 7-78

- Dynamics side-chain linking
  - dynamics side-chain bus operation 4-21
  - dynamics side-chain bus set-up procedure 4-21
  - dynamics side-chain busses 4-20
  - dynamics side-chain link right 4-18
  - dynamics side-chain link right set-up procedure 4-19

---

## F

- Fader paging 3-8
- Fader panel 6-6/7
- Faders, automating
  - dropping out of write on subsequent mix passes 7-78
  - global, touch and audition functions 7-67
  - motorised fader controls 7-64
  - to automate moves on one fader 7-65
  - to record absolute moves for a number of faders 7-67/68
  - to record auditioned levels 7-69
  - to trim moves for a number of faders 7-68
  - to trim moves for one fader 7-65/66
- Faders, select to 3-14/16
- File data storage 7-7
- Film mode 7-80
- Free assign area & dynamics panel 3-11, 6-20
  - 6 definable knobs & 6 switches 6-21
  - 12 x selector blocks 6-20/21
  - dynamics area 6-22
  - dynamics side-chain equaliser 6-24
  - virtual panels illustration 6-23

---

## G

- Global ready enable 7-81
- Glossary 8

---

## I

- Input channel & inserts, equaliser and filters panel 3-10, 6-17
  - channel path selectors 6-18
  - equaliser & filters section 6-18/19
  - five band equaliser 6-19
  - high & low pass filters 6-19
  - input channel & inserts section 6-17/18
  - panel illustration 6-17
- I/O GUI
  - assigning channel inserts 5-20
  - assigning line inputs 5-19
  - assigning mic inputs 5-15
  - assigning M/T group inserts and outputs 5-25
  - assigning M/T inputs 5-17
  - I/O pop-up colour coding 5-12
  - MADI links 5-12
  - printing GUI pages 5-13
- I/O racks 1-3
  - analogue I/O 1-3
  - digital I/O 1-3
  - modules 6-97

---

## K

- Keyboard entry to record arm channel tracks 6-75

---

## L

- LCD channel screen panel 6-31

---

## M

- Machine remotes screen 7-61/63
- Machines screen page 7-30/31
- Main output bus GUI 5-39
- Master fader panel 6-38
- Merge/assemble screen 7-40/45
- Merge command lines 7-44
- Meter bridge
  - mono channel meters 6-90/91
  - other meter bridge indicators 6-95
  - stereo centre section meters 6-92/94
- MIDI
  - MIDI bars & beats 7-93/94
  - MIDI control pages 7-89
  - setting MIDI parameters 7-90/92
- Mixes & cues screen 7-35/36
  - cues 7-38/39
  - mixes 7-36/37
  - screen page 7-35
- Mixing
  - dropping out of write on subsequent mix passes 7-21
  - getting started 7-9
  - OXF-R3 logo screen 7-9
  - to assemble a mix 7-24/26
  - to automate a pan move (or any other knob) 7-23
  - to automate cuts 7-13/15
  - to automate fader moves 7-20
  - to name artists/projects & titles 7-10
  - to record absolute moves for a number of faders 7-22
  - to save a mix 7-19
  - to set cue points 7-11/12
  - to trim fader moves 7-22
  - to trim moves for a number of faders 7-22
- Mixing to main output bus
  - block schematic of stereo and surround mix-down 4-23
  - channel signal to the main output 4-26
  - clearing multitrack bus destinations 4-25
  - main bus to multitrack 4-25
  - main output bus set-up 4-24
  - multi-channel main output bus 4-22
  - routing, stereo and surround panning in general 4-28
  - surround routing and panning when mixing to main output 4-27
- Monitor panel 6-39
  - ancillary functions panel area 6-55/60
  - central stereo meters section 6-46
  - centre section meters 6-44/45
  - CR monitor section 6-40/43
  - external sources section 6-47/48
  - foldback groups 1-4 section 6-50/51

oscillator section 6-61  
solo, AFL & PFL modes section 6-54  
studio LS section 6-49  
talkback & listen section 6-52/53  
Multi-format buttons 3-12  
Multi-format LS calibration A-3  
  calibration procedure A-4/5  
Multi-stem set-up 4-29  
  assigning stems using the GUI 4-50  
  automation switches for the motorised joysticks 4-46  
  block schematic 4-30/31  
  fold-down matrix GUIs 4-52  
  monitor path 4-36/39  
  multi-channel routing & surround panning 4-42/43  
  multi-format mode 4-44/45  
  other routing selections 4-45  
  routing and monitoring a signal 4-47  
  routing selections for other stems 4-45  
  routing selections for the active stem 4-44  
  set-up procedure 4-32/34  
  source channels 4-40/41  
  stem monitor switch functions 4-49  
  stem monitor switch mapping 4-48  
  stem monitor switching 4-48  
  stem monitor switching GUI set-up 4-50  
  stereo mode 4-44  
  sub level 4-47  
Multitrack panel 6-25/27  
Multitrack, routing for multitrack, SSGs & multi-format 3-12

---

## N

Networking R3 system 7-106/107  
Notes icon 7-4  
Numeric key-pad, to enter timecode 6-73

---

## O

Offline automation 7-84/85  
  offline cuts edit procedure 7-87/88  
  offline cuts GUI 7-86/87  
  offline faders edit procedure 7-85/86  
OXF-R3 logo screen 7-9, 7-27

---

## P

Pans panel 6-13/14  
Pans, select to 3-17, 6-15/16  
Preferences GUI (central screen) 7-101  
  automation tab 7-103/104  
  diags tab 7-105  
  jog tab 7-104/105  
  pointer tab 7-105  
  RSL tab 7-108/109  
  session tab 7-102/103  
  setting up a network drive 7-106/107

Preferences GUI (channel screens) 5-30/38  
  fast insert I/O 5-36/37  
  I/O alias 5-34  
  M/T scribbles 5-35  
  sample rate converter 5-38  
Programme material 7-8

---

## Q

Quick copy EQ 7-60  
Quick rollback 6-73  
QWERTY keyboard 6-88

---

## R

Related manuals 7  
Release notes A-2  
Routing buttons 3-12  
Routing for multitrack 3-12  
Routing panel 6-28/30

---

## S

Select to faders 3-14/16, 6-9/12  
Select to pans 3-17, 6-15/16  
  definable knobs 3-17  
Selective automation isolate 7-79  
Sends 1-24 panel 3-13, 6-32/37  
  post fader headphone feed 6-36  
  post M/T send fader headphones feed 6-37  
  pre fader headphones feed 6-35  
  source points for the sends 6-34  
Session Management System  
  automatable controls 7-6  
  basics 7-2  
  files structure 7-3/4  
  snapshots 7-5  
  snapshots file structure 7-5  
Shutdown procedure 2-4/5  
Signal flow 1-6/7  
Signal paths  
  broadcast mode - channel input source 4-13  
  broadcast mode - channel output source 4-13  
  broadcast mode - monitoring the multitrack 4-14  
  broadcast mode - setting up 4-12  
  channel metering 4-15/17  
  default signal path 4-2  
  dynamics side-chain linking 4-18/21  
  global select source for all channels 4-10  
  in-line channel for recording to a multitrack 4-8  
  in-line channel multitrack recording configuration 4-7  
  in-line channel with post fader insert in the monitor path 4-9  
  mix-down example configuration 4-4  
  mix-down with post channel fader insert 4-6  
  mix-down with processing in the channel path 4-5  
  mixing to the main output bus 4-22/28  
  recording to a multitrack 4-7  
  send 1 post fader headphones feed 4-11  
  send 1 pre fader headphones feed 4-10

# Index

---

- Signal processing (SP) rack 1-3, 6-96
- Snapshots, copy & link screen 7-49
  - adjusting offsets with faders and knobs 7-57
  - copy 7-54/57
  - link 7-58/59
  - quick copy 7-54, 7-57
  - quick copy and link 7-55
  - quick link 7-55, 7-58
  - selector definitions 7-50
  - snapshot 7-50/53
- Software installation A-2
- Specifications
  - audio specifications A-7/13
  - dimensions & weight A-15
  - general A-6/7
  - I/O rack system A-14/15
  - product identities A-16
  - supplied accessories A-16
  - system signal to noise performance A-11
- Start-up logo screen 7-27
- Start-up procedure 2-2/3
- Stem selectors 3-12
- Super send group buttons 3-12
- Super send groups, sends output and multi-format panel
  - multi-format and monitor 6-83/85
  - panel illustration 6-76
  - send outputs 6-77/78
  - super send groups 1-16 panel section 6-81/82
- System concept diagram 1-2, 6-2
- System overview 1-2/3
- System screen page 7-28/9

---

## T

- Trackerballs 6-89
- Track lists screen 7-46/48
  - import track list pop-up 7-47

このマニュアルに記載されている事柄の著作権は当社にあり、説明内容は機器購入者の使用を目的としています。

従って、当社の許可なしに無断で複写したり、説明内容（操作、保守等）と異なる目的で本マニュアルを使用することを禁止します。

The material contained in this manual consists of information that is the property of Sony Corporation and is intended solely for use by the purchasers of the equipment described in this manual.

Sony Corporation expressly prohibits the duplication of any portion of this manual or the use thereof for any purpose other than the operation or maintenance of the equipment described in this manual without the express written permission of Sony Corporation.

Le matériel contenu dans ce manuel consiste en informations qui sont la propriété de Sony Corporation et sont destinées exclusivement à l'usage des acquéreurs de l'équipement décrit dans ce manuel.

Sony Corporation interdit formellement la copie de quelque partie que ce soit de ce manuel ou son emploi pour tout autre but que des opérations ou entretiens de l'équipement à moins d'une permission écrite de Sony Corporation.

Das in dieser Anleitung enthaltene Material besteht aus Informationen, die Eigentum der Sony Corporation sind, und ausschließlich zum Gebrauch durch den Käufer der in dieser Anleitung beschriebenen Ausrüstung bestimmt sind. Die Sony Corporation untersagt ausdrücklich die Vervielfältigung jeglicher Teile dieser Anleitung oder den Gebrauch derselben für irgendeinen anderen Zweck als die Bedienung oder Wartung der in dieser Anleitung beschriebenen Ausrüstung ohne ausdrückliche schriftliche Erlaubnis der Sony Corporation.

OXF-R3 (UC/CE)  
3-860-150-05(1)

**Sony Corporation**  
B & P Company  
<http://www.sony.net/>

Printed in Japan  
2001.12.13  
© 1997