

2070

Solution Delivery Series

TWO CHANNEL TUBE MIC AND
INSTRUMENT PREAMPLIFIER

with 24-Bit 96kHz ADC

Instruction Manual

P/N 999-4260
Revision 1
Released 02/04/2005

Manufactured by
Aphex Systems Ltd.
11068 Randall St.
Sun Valley, CA 91352
USA

APHEX
S Y S T E M S

Copyright 2004 Aphex Systems Ltd. All rights reserved.

Produced by: Donn Werrbach. Creation tool: Adobe InDesign 2.0

A MESSAGE FROM THE PRESIDENT

Dear Aphex Customer,

We are pleased to present the Model 207D Tube Microphone and Instrument Preamplifier with analog and digital outputs. This continues the commitment made in all the products in our Solution Delivery Series- high performance audio; extensive, useful and unique features; attractive and clean front panel design; and cost effective pricing.

Rather than being locked into a channel strip that has many functions but does few or none well, the Model 207D gets you the best possible preamplifier and the freedom to choose the best processing for your application. Loop the output of the processing back into the insert of the 207D and you have a complete front end without any compromises.

As with all our products, we are very proud of the ingenuity of design and the manufacturing quality of the Model 207D. We love to hear from you, our customers, about your experiences with any of our products. Our customer support is unmatched in the industry, so please do not hesitate to contact us.

Sincerely,



Marvin Caesar

Safety Declarations

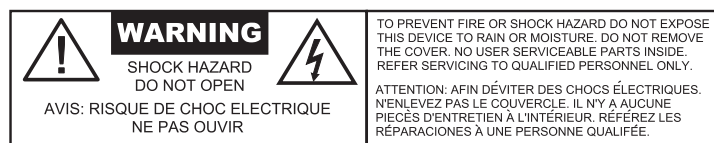

CAUTION: For protection against electric shock, do not remove the cover. No user serviceable parts inside.

WARNING: This equipment has been tested and found to comply with the limits for a Class A digital device pursuant to Part 15 of the FCC Rules. These limits are designed to provide reasonable protection against harmful interference when the equipment is operated in a commercial environment. This equipment generates, uses, and can radiate radio frequency energy and, if not installed and used in accordance with the operating guide, may cause interference to radio communications. Operation of this equipment in a residential area is likely to cause interference in which case the user will be required to correct the interference at his own expense.

The user is cautioned that changes and modifications made to the equipment without approval of the manufacturer could void the user's authority to operate this equipment.

It is suggested that the user use only shielded and grounded cables to ensure compliance with FCC Rules.



Table of Contents

1.0 CONTROLS & INDICATORS PLUS QUICK SETUP	4
2.0 INTRODUCTION	
2.1 What Distinguishes the Model 207D.....	6
2.2 What Does the Tube Add?	6
2.3 What Else Is So Special?	7
2.4 What About The Digital Audio?	7
2.5 Block Diagram	8
3.0 INSTALLATION AND INTERFACING	
3.1 Installation	9
3.2 Rear Panel View	9
3.3 AC Line Connection	9
3.4 Mic Input Connections	9
3.5 Instrument Inputs	9
3.6 Insert jack	9
3.7 Output Connectors	10
3.8 Operating Level Switch	10
3.9 Output Match	10
3.10 Output Trim	10
3.11 Digital Outputs (AES3 and S/PDIF)	10
4.0 USING THE 207D	
4.1 Split Independent Preamp Sections	11
4.2 Using the Instrument Input	11
4.3 Using the Microphone Input	12
4.3.1 Using Phantom Power	12
4.3.2 Using the Polarity Switch	12
4.3.3 Using the Pad	13
4.3.4 Using Low Cut	13
4.3.5 Using MicLim™	13
4.4 Using Word Clock	14
4.4.1 External WC	14
4.4.2 Internal WC	14
4.5 Using Digital Audio (S/PDIF Output)	14
4.6 Replacing Your Console's Mic Preamps	14
4.7 Bypassing the Console Altogether	15
4.8 Using the 207 for Stereo Recordings	15
4.8.1 Spaced Pair Technique	16
4.8.2 X-Y Technique	16
4.8.3 M-S Technique	16
4.8.4 Binaural Technique	16
4.8.5 Further Reading	16
5.0 WARRANTY AND SERVICE	
5.1 Limited Warranty	18
5.2 Service Information	18
6.0 SPECIFICATIONS	
6.1 General Specifications	19
6.2 Architectural Specifications	20
7.0 APPENDICES	
Appendix A - Introduction to Balanced and Unbalanced Wiring	21
Appendix B - Dealing With Ground and Hum	22
Appendix C - Proper Wiring Techniques	24
Appendix D - Standard Cable Wiring	25

1.0 Controls and Indicators with Quick Setup

POWER ON

When the unit is turned on, audio is not passed through to the output for a few moments while the tube warms up. During the warm-up time, the power indicator is yellow. When the power indicator turns green, the audio will pass through to the output. This protects you from heavy turn-on thumps.

MICROPHONES

You can use any type of balanced, low impedance microphone from dynamics to ribbons to condensers. The 207D supplies a very clean and stable 48V phantom voltage source suitable for even the most expensive microphones. Phantom voltage is separately selectable on or off for each channel at the front panel.

OUTPUTS

The two outputs can be used at the same time. They are not fully isolated from each other, however. To unbalance the XLR output, simply use pin 2 (high) and pin 1 (ground) leaving pin 3 either grounded or floating. You may ground the ring of the phone jack, as will happen when you plug in a mono style phone plug. The XLR output will still remain balanced. The output impedance of the XLR jack is low enough to optimally drive loads of 600 ohms and higher. It is designed to interface with fully professional balanced gear. The phone jack output impedance is significantly higher but meets the requirements for driving typical semi-pro ("prosumer") balanced and unbal-

anced equipment.

INSERT JACK

This allows you to insert any kind of line level equipment into the signal path between the 207D's front-end preamps (mic and instrument) and tube output stage. The operating level at this jack is in the vicinity of IHF level (-10dBV). You should set up your inserted outboard gear for -10dBV I/O sensitivity. All Aphex processors can be readily set to operate at this level.

HEADROOM METER

As the level approaches 0dB, you run out of headroom and the output will go into clipping unless MicLim is turned on. There is a span of 27dB indicated, so you can watch your signal level for safety and convenience. When MicLim is on, the peak level will be held to about 3dB under clip for over-level inputs rising as much as 20dB beyond the normal overload point.

INSTRUMENT INPUT

This input is available at the front panel through a quarter inch phone jack. The input impedance is 1 megohms to match all coil type pickups and all powered pickups. Fully passive piezo pickups will work, but may not deliver full tone. High impedance unbalanced microphones will usually work extremely well with this input. When a plug is inserted, the mic input is inoperative.

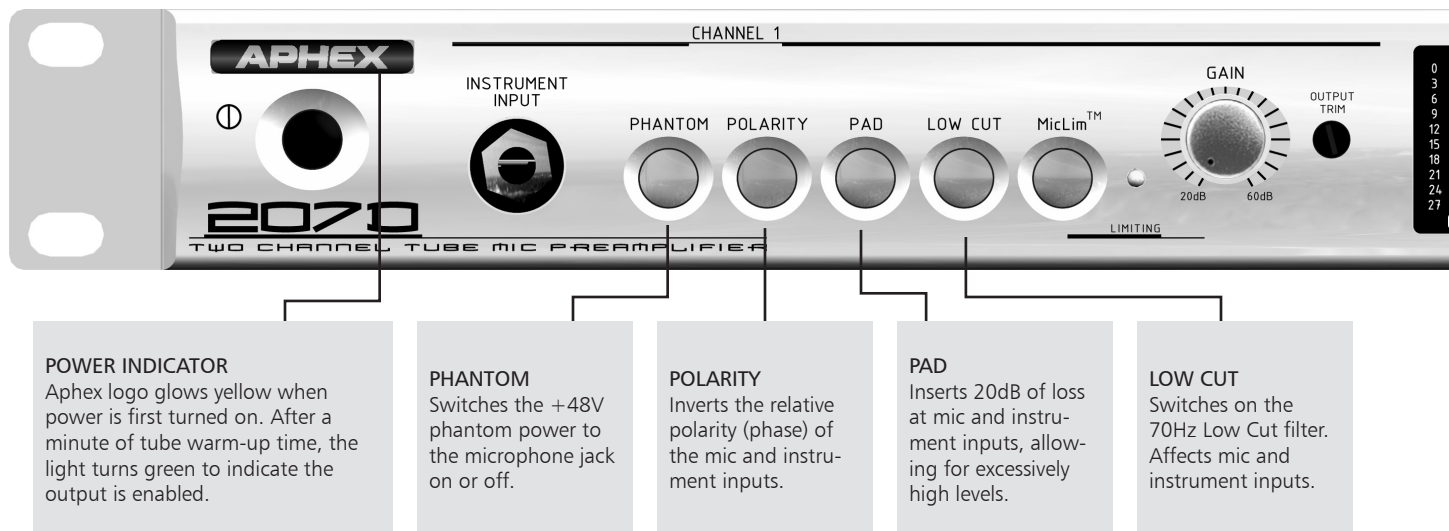

OPERATING LEVEL

This adapts the model 207D's internal dynamic range to match either professional balanced equipment or semi-professional unbalanced equipment at the output. It controls both output jacks. Both jacks supply the same output level. Set as needed.

DIGITAL AUDIO

In external sync mode, the 207D locks up to frequencies between 32 and 96kHz. The push button located in the meter window toggles the operating mode among the internal frequency modes and external sync. The AES3 and S/PDIF outputs will properly interface with all standard inputs. Follow the procedures recommended in this manual for proper installation and use.

OUTPUT HEADROOM METER

Indicates the available headroom in decibels below clipping. At 0dB the output level reaches the maximum level available at all outputs depending upon the Output Trim and Operating Level settings.

Standard Hookup to Rear Panel
ONE CHANNEL SHOWN

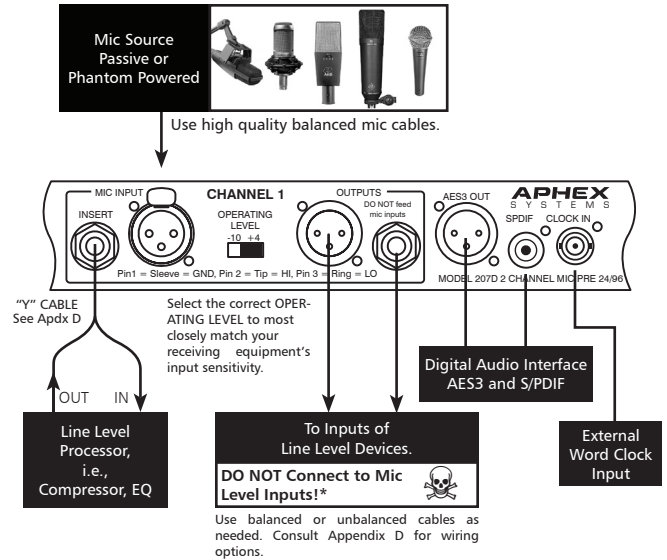

***Why You Shouldn't Connect a 207D's Output to a Mic Level Input.** The bottom line: you will get a lot of noise and possibly a lot of distortion. The Model 207 is designed to generate a line level output from a mic level input. It optimizes the signal to noise ratio by giving you a strong signal far above the preamplifier's basic self noise level. This strong output signal can be up to 65dB higher than the mic signal. It is perfect in level for a standard line input of a mixer or console. However, it will overload a mic input. If you turn down the 207's gain to reduce its output low enough to stop overloading the mic input of your mixer, then your large console gain amplifies the basic noise floor of the 207. That will result in a very poor signal to noise ratio. Always use the most gain possible in the 207 and adjust your mixer's fader or line input gain to accept it, and never feed a mic input from a 207D.

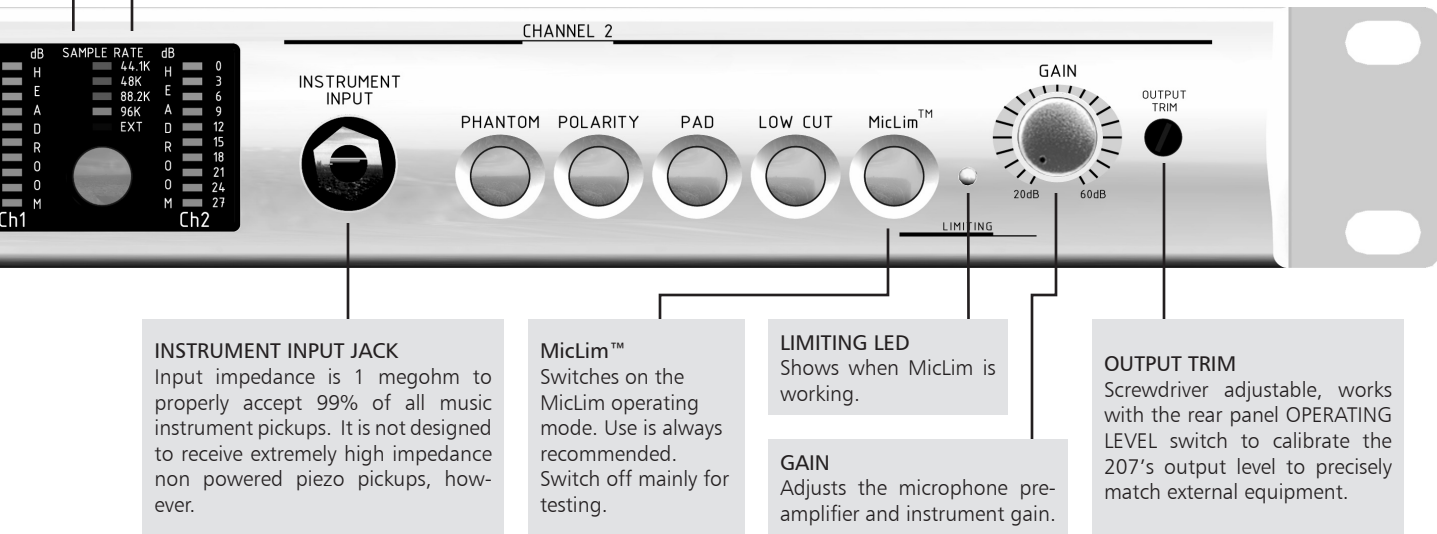

2.0 Introduction

2.1 WHAT DISTINGUISHES THE MODEL 207D

There are certainly a lot of mic preamps available in the world. It seems that every audio equipment company has at least one model to offer. A study of currently available products shows that a large percentage use similar circuits based on one or two popular commercial i.c. chips. The basic design has been done by the chip maker and the chips do a competent job. We could have brought out such a "me too" design, but it is important to Aphex that we offer products that are more than just "competent". They must also be different and better. That is why we did not introduce our first mic preamp until we invented something that would make all the difference.

That invention turned out to be a new and unique way to use a vacuum tube in a circuit that yields the clear and detailed tube sound yet has none of the limitations of conventional tube circuitry like short life, noise, heat, and low bandwidth. That invention is called the Reflected Plate Amplifier (RPA), and was granted U.S. Patent #5,450,038. We introduced our first microphone preamplifier incorporating the RPA, the Model 107, in 1996 and it soon became one of the most popular mic preamps in the world. People appreciated the difference it made in the quality of their work. Tens of thousands of 2-channel units were sold.

More recently, we came up with another invention pertaining to mic preamps. We had the idea that if we could build a mic preamp that not only sounded great, but also had a way to automatically prevent input overloading over a significant dynamic range above normal clipping, then we would have another innovative hit on our hands. Many months of research went into inventing a method to achieve this goal. When we succeeded, we called it MicLim™. Later, we introduced the Aphex Model 1788 Remote Controlled Mic Preamp including the MicLim™ feature. Months of trials proved it to be extremely useful in live sound reinforcement applications. Additional testing showed it is also useful in recording. When we next introduced our very high-end Aphex Thermionics™ Model 1100 Thermionic Mic Preamp, we included the MicLim™ feature and it has received high acclaim among some of the world's top sound engineers.

Meanwhile, our Model 107 remained a solid product in the marketplace because of its low cost, high

performance and value. However, after enjoying many years of sales, we thought we owed it to the world to update the Model 107 with the new things we have learned and developed since its inception. Hence, the 207 was born. Production of the Model 107 was discontinued. In the present configuration, a digital output is added and the model updated to the 207D.

In addition to improving on the Model 107, the Model 207D is a whole new product. We transported the front-end and RPA components that characterize the sound of the 107 but we completely revised our thinking about every other detail. We added the MicLim™ feature and a professional quality instrument input. We even added a processing insert jack so you can insert EQ, gating, or compression after preamplification but before the tube output stage. In this way you always get the sonic benefits of the tube. We created a totally new and attractive style for the chassis and panel that makes it look as great as it performs.

With the Model 207D you are getting exclusive Aphex design advantages and legendary sonic quality at a very modest price. We hope you enjoy using it for many years to come.

2.2 WHAT DOES THE TUBE ADD?

The Model 207D uses a discrete solid-state transformerless front end carefully crafted for extremely low noise and high common mode rejection. It runs without feedback, making it nearly ideal as an input stage, never reflecting any feedback current back out to the microphone. Certainly, the input stage has a measurable distortion level, but it is very low and does not impart any appreciable tonality. The tonality for which our tube preamplifiers are famous is due exclusively to the tube.

Our unique and stable RPA tube circuit retains the tube's transconductance and grid characteristics while at the same time creating a much more efficient amplifier stage that runs on low power supply voltages. We designed the RPA in the Model 207D to deliver a specific tube distortion curve that subtly "voices" the preamp. If you have been using the Model 207D or its predecessor, the Model 107, then you know what that means. The preamp is characterized by most users as very transparent and detailed, but not colored. The beauty of tubes is that their dis-

tortion is so natural. The very slight tube distortion of the Model 207D comprises typically less than 0.02% of second order harmonics at average levels. What is even more interesting is that this curve follows the tube's law as regards level, and furthermore, it responds to certain very subtle dynamic space-charge effects known only in tube amplifiers. Thus, the sound with an RPA can have a large and open feeling that is very natural and transparent.

2.3 WHAT ELSE IS SO SPECIAL?

It may sound trite, but everything else about the Model 207D is special. When we designed its circuitry and decided upon its features, we took into consideration a very wide range of factors. We "blocked in" the things that our marketing experts wanted, but then made sure that every circuit and feature could work in harmony. Some things were discarded by engineering because they would have compromised the sound. Once we had the Model 207D very well defined, we went to work at embodying the circuits cleanly and cleverly, using some great ideas from the Model 107, but redesigning most of it from scratch through computer modeling and simulation and finally through actual physical prototypes and listening sessions. There are no databook or textbook pre-amplifier circuits in the 207D. It's all Aphex.

That being said, let us point out just a few of the things that are special about the Model 207D. Then, as you read more of this manual, you will gain appreciation for many other special aspects of this product. First, let's look at the front end. Other preamps, even those costing many times more, pass the mic signal through switch contacts to enact the pad and polarity features. This eventually leads to contact distortion creeping into the sound because switch contacts will eventually oxidize and, in the very least, need to be operated frequently to keep themselves clean. That is a big problem, especially for fixed installations where it is impossible to exercise all the switches regularly (daily?).

We used expensive d.c. operated, sealed, bifurcated gold contact relays to switch these functions. These relays never oxidize and can remain stationary for many years without contact distortion.

Next, let's look at the low cut filter. It is a second order active filter that is designed for musicality,

not just rumble cutting. We very slightly peaked the response at 120Hz by about 1dB so there will be a natural phase compensation effect in the important low-mid bass region helping regain a greater sense of bass presence. That benefit is immediately apparent to experienced mic preamp users. We received so much praise for this type of filter in the Model 107, that we kept it for the 207D.

Just one more mention. Let's look at the RPA tube output stage. Here, we merge a real operating vacuum tube into the world of semiconductors. The tube serves as the main gain element and brings us all of its warmth and clarity while remaining directly linked to its solid-state support unit. There are no transformers or high voltage supplies, yet the strength of the output signal is more than powerful enough to drive any practical load to full professional levels with ease. Because of the unique capabilities of the RPA circuit, we were able to mix the mic and instrument signals directly to the tube without any interaction. The result is exceptionally high performance.

2.4 WHAT ABOUT THE DIGITAL AUDIO?

With the superb audio quality of the 207D, it is obvious that only a high grade ADC will be able to capture that quality and bring it into the digital domain. We incorporated a 24 bit ADC that has a digital dynamic range greater than the analog circuitry. In this way, perfect dithering will be provided by the analog noise floor. That is the most ideal form of dither since it avoids the harshness of digitally synthesized dither noise.

The AES3 and S/PDIF digital audio outputs are of 24-Bit resolution. The analog noise floor, even though exceptionally low in level for a mic preamp, will typically dither the 24 bits into the 16-bit level which makes it suitable for all projects, including anything that will eventually end up on CD. Even if your digital studio truncates the audio word length to 16-Bits, the 207D's natural dither will still make it sound great.

Introduction

2.5 SIMPLIFIED BLOCK DIAGRAM

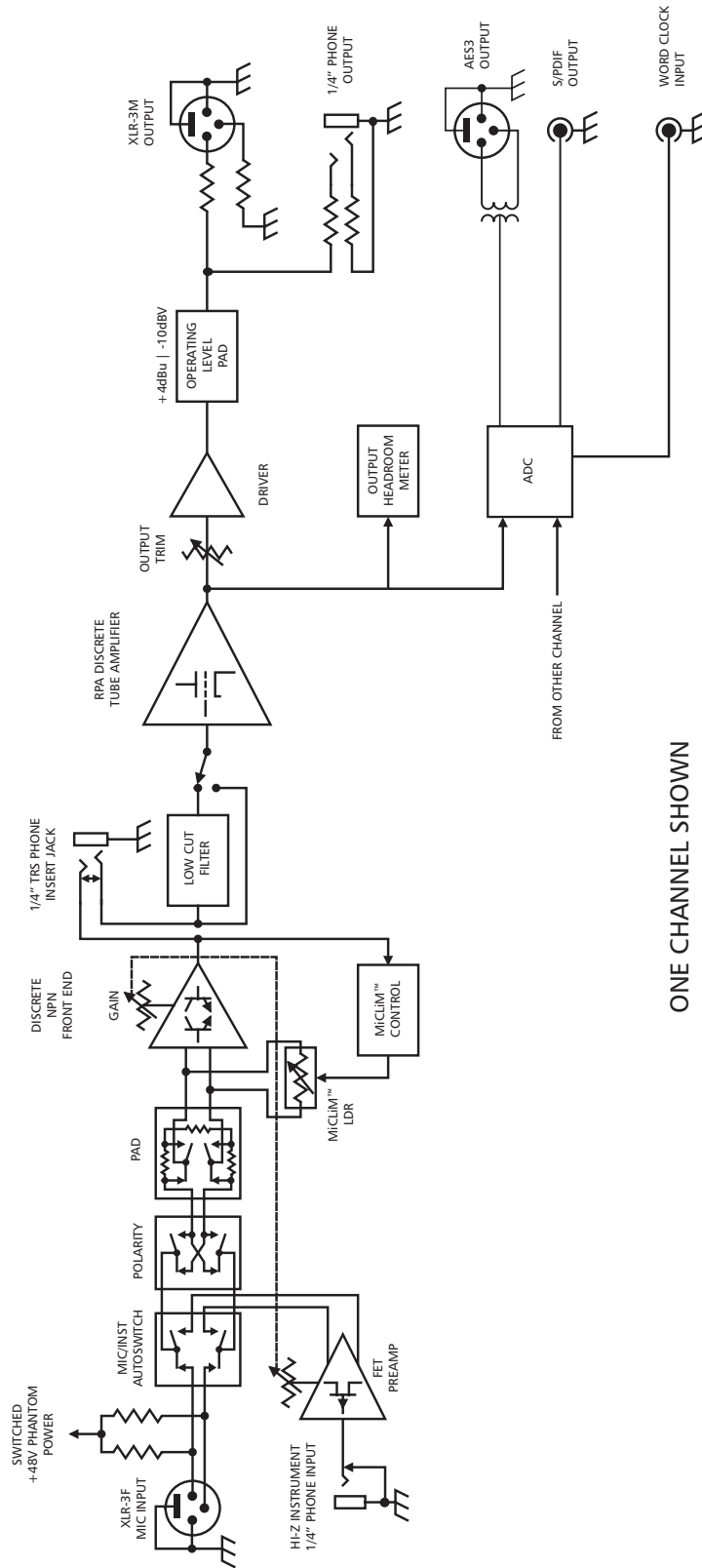

ONE CHANNEL SHOWN

3.0 Installation & Interfacing

3.1 INSTALLATION

The Model 207D occupies a single rack space (45mm or 1-3/4 inches) of a standard EIA equipment rack.

When rack mounting, use appropriate cushioned rack screws. Never restrict air flow through the device’s vents. When installing the units into a rack, distribute the units evenly. Otherwise, hazardous conditions may be created by an uneven weight distribution. Connect the unit only to a properly rated supply circuit. Reliable earthing (grounding) of rack mounted equipment should be maintained. Try not to position the 204 directly above devices that generate excessive heat such as power amplifiers (unless adequately ventilated) or near equipment with heavy transformer hum fields.

3.2 REAR PANEL VIEW

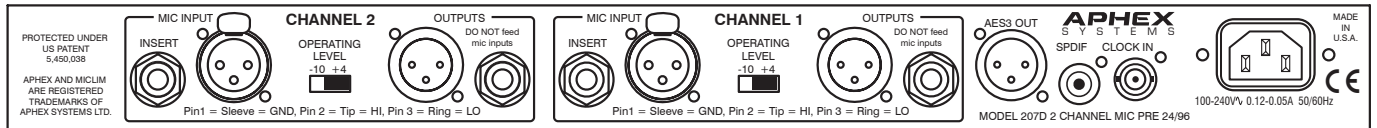

3.3 AC LINE CONNECTION

Use only a power cord that carries approvals for use in your location. The 207D’s internal power supply is designed to operate from all nominal power sources from 100 to 240 volts a.c. at 50/60Hz without requiring the user to change any settings. In case of failure, do not attempt to change the internal fuse because it will never blow unless the power supply fails catastrophically. The power supply will need to be serviced by a competent service technician in such a case.

3.4 MIC INPUT CONNECTIONS

The MICROPHONE input connectors are located on the rear panel. They are the standard XLR-3F type. Use only properly wired balanced mic cables.

PROPER MICROPHONE CABLE WIRING



CAUTION: Beware that 48 volt PHANTOM POWER may be applied to either or both of the microphone inputs, creating a potential shock hazard. Standard practice dictates shutting off the phantom power before plugging or unplugging microphones. Wait at least 10 seconds for the voltage to fall sufficiently. This is not only for safety, but for protection of sensitive microphones against power inrush.



3.5 INSTRUMENT INPUTS

The INSTRUMENT inputs are located on the front

panel providing a high input impedance of 1 megohms. The instrument jack accepts standard 1/4” phone plug music instrument cords (i.e., guitar cords). This input is also suitable for high impedance microphones having cables with 1/4” phone plugs. The do-it-yourselfer can refer to appendix D for numerous examples of proper cable and plug wiring.

3.6 INSERT JACK

The Model 207D allows you to insert additional signal processing between the mic preamp’s front end stage and the tube output stage. This is clearly shown in the 207D’s block diagram at left. The interconnect is unbalanced by way of a stereo (TRS) I/O jack on the rear panel. You will need a conventional “Y” cable to interface with external equipment. Such cables are available commercially. Make sure you have the correct cable: tip is send, ring is receive, and sleeve is ground. Check the following chart. Nominal level is -10dBV.

3.7 OUTPUT CONNECTORS

The output connectors are located on the rear panel. There are two output connectors per channel, one 1/4” TRS phone type and one XLR-3M type. They

Installation & Interfacing

TABLE 3-1 - INSERT "Y" CABLE PINOUTS

Tip -SEND
Ring - RETURN
Sleeve - GND

may both be used at the same time to feed separate equipment. Both jacks run at the same output level but are not fully isolated from each other. Shorting out the XLR will take down the 1/4 phone. However, shorting the 1/4 phone will not affect the XLR. You may safely plug a mono style (TS) 1/4" phone plug into the phone jack and take an unbalanced output. The diagram shown below explains the electrical relationship of the two output jacks.

If you intend to take an unbalanced output from the XLR jack, you must not ground either pin 2 or 3. Simply take from pin 2 and use pin 1 for ground. Leave pin 3 unconnected.



Refer to Appendix C & D for more information on the proper wiring of balanced and unbalanced lines.

3.8 OPERATING LEVEL SWITCH

Between the input and output jack is located the Operating Level switch. This sets the nominal operating level for both output jacks simultaneously to either -10dBV or +4dBu. You should select the position that most closely matches your receiving equipment. In the event that you are not familiar with the operating levels of the equipment in your system, you should consult your manuals. In general, most entry

level "home studio" equipment operates at -10dBV as it is assumed that the user will likely intermix home hi-fi equipment, such as cassette decks and CD players. Most professional recording gear and live sound equipment operates at +4dBu.

3.9 OUTPUT TRIM

In addition to the OPERATING LEVEL switch on the back panel, there is a front panel trim for precise output level matching. The OUTPUT TRIM is recessed to stay out of your way and can be adjusted with a small screwdriver blade. The range of adjustment is 0 to -12dB. First, set the OPERATING LEVEL switch to the appropriate position. Next, using a loud input or an oscillator, drive the OUTPUT HEADROOM meter to ZERO. Set the OUTPUT TRIM to just barely drive your equipment to its maximum input level. If you are in doubt about how to do this, simply set the OUTPUT TRIM fully clockwise and rely on the OPERATING LEVEL switch to get you close enough.

3.10 WORD CLOCK IN (BNC Jack)

If you use a house or master clock source, then connect it here. The input impedance is 75 ohms. You should then be sure the sync mode is set to EXT on the front panel. If you don't seem to get any S/PDIF output, then you should double check if external clock is present.

3.11 DIGITAL OUTPUTS (AES3 and S/PDIF)

Both outputs can be used at the same time. Signal will be present if the 207D is set to any internal clock frequency or is externally clocked by a valid word clock source from 32 to 96kHz. The outputs are muted if there is no valid clock.

**OUTPUT JACK SCHEMATIC
with OPERATING LEVEL SWITCH**

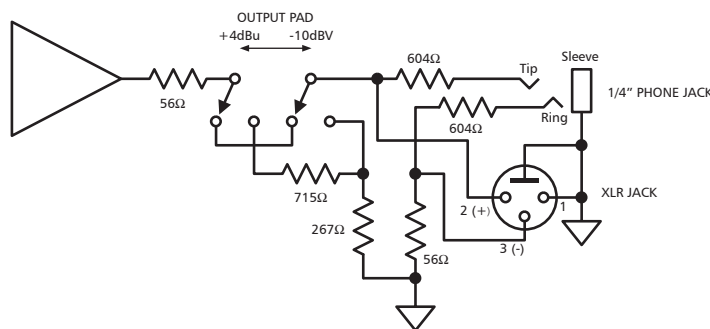

FRONT PANEL VIEW

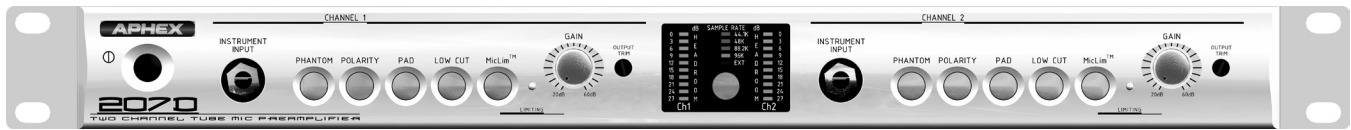

4.1 SPLIT INDEPENDENT PREAMP SECTIONS

The Model 207D is a two channel unit. It contains two separate, independent, preamplifier channels. Each channel operates as a mic preamp or an instrument preamp. Plugging into the instrument jack automatically disables the mic input and substitutes the instrument input.

4.2 USING THE INSTRUMENT INPUT

This input is designed to work with most standard instrument pickups, both active and passive. Active pickups have an amplifier built into or attached to the instrument or instrument strap. These are identified by running on a battery. Active pickups generally have a higher output level than passives, but not always. Passive pickups couple directly through the instrument cord to the music amplifier or preamp.

Magnetic pickups are exclusively associated with steel stringed instruments like basses and guitars. These pickups are wound with coils of wire that generate an output voltage when the strings interfere with a magnetic field set up by an internal permanent magnet.

Acoustic instruments that don't use steel strings are usually amplified from piezoelectric pickups placed on the instrument where vibrations will twist or bend the piezo crystal to generate a voltage output.

90% of all piezos in use are amplified, but passive pickups are available. Passive piezos cannot usually be connected directly to a music amplifier with good results. The sound will be very thin and weak. They require a special input stage that provides extra gain and an extremely high impedance like 10 megohms or more. Magnetic passive pickups and most active pickups (piezo and otherwise) are most suited to a 1 megohm impedance at the amplifier input. Since we wanted to design the Model 207D to meet the widest requirements, we gave it a 1 megohm input

impedance. Therefore, we cannot recommend it for any type of passive piezoelectric pickup.

That said, let's look at this input a little further. The INSTRUMENT jack is located on the front panel where it can be accessed by musicians most easily. The front end of this preamp is a low noise FET amplifier stage so you should notice this preamp is unusually quiet. However, because of the high impedance nature of an instrument pickup, the noise level of the INSTRUMENT preamp will be higher than the mic preamp for the same amounts of gain taken. This is a law of physics and not a design fault. To help mitigate the noise problem when the INSTRUMENT is not going to be used, we designed a way to defeat the INSTRUMENT input and its associated noise.

TIP: You will reduce the INSTRUMENT preamp noise by running the volume on the instrument higher and running the 207D's GAIN lower.

4.3 USING THE MICROPHONE INPUT

The Model 207D is perfect for all types of microphones, either powered or not. We encourage you to try every mic you own with the 207D.

Many features of the 207D are standard with all professional preamps - polarity - pad - etc. Some features are unique and we hope you will fully exploit them.

All controls for the MIC preamp are on the front panel. You won't have to reach around back for the phantom power switch or pad. Please read the rest of this section to pick up any tips we may have for you.

4.3.1 USING PHANTOM POWER

Active microphones that take power through the standard mic cable fall into a class called "phantom powered" mics. The power is called "phantom" because it rides the mic cable invisibly, without

Using the 207D

interfering with the audio signal carried on the same wires.

The industry standard phantom power source is positive 48 volts d.c. supplied to pins 2 and 3 through

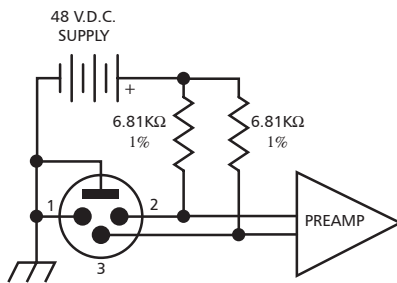

Figure 4-1 Phantom Powering

precision low noise 6.81KΩ resistors. You may note from spec sheets that many mics rated for phantom power actually run at something less than 48 volts. For example, the Audio Technica AT3031 small diaphragm condenser mic is rated for 11 to 50 volts at 3 milliamps. On the other hand, the Neumann TLM193 spec sheet states only that the supply voltage should be 48 +/- 4 volts and the current consumption is not stated. Don't let these specifications confuse you. They all run perfectly well off the standard phantom power source described above. For the technically interested, here's why.

The 6.81KΩ resistors mentioned are shown in figure 4-1 below. Since the power to the microphone is carried equally (a requirement carefully observed by all mic manufacturers) on pins 2 and 3, it is like powering the mic through a single series resistance equal to the two resistors in parallel, which is a resistance of half, or 3.405KΩ. A voltage drop will occur across the series resistance equal to the microphone's current consumption times the series resistance. In the case of the AT3031, consuming 3mA, the drop is $.003 \times 3405 = 10.22$ volts. That means the voltage actually appearing on pins 2 and 3 is $48 - 10.22 = 37.78$ volts. That is why, if you use a voltmeter to check phantom power while the mic is plugged in, you will always see something less than 48 volts. This is not a fault with the mic preamp.

Plugging and Unplugging a microphone when

phantom power is switched on can sometimes be dangerous. Some microphones can be damaged by power inrush. Good practice calls for switching off the phantom power before changing or inserting a microphone. Wait long enough to hear the mic go silent before unplugging.

You should be aware of the shock hazard with the phantom power system. Long, open mic cables that are disconnected from the preamp while phantom is on can hold a d.c. charge for long periods of time, sometimes days. They will act as a storage capacitor and **you can get shocked most rudely** by holding the XLR plug and touching the pins inside. Also beware of microphone patch bays that may carry phantom voltage. Don't hold the patch cord by the metal parts, only the plastic shell.

4.3.2 USING THE POLARITY SWITCH

There will be times when you need to reverse the polarity (phase) of a mic signal. Vocalists monitoring themselves on headphones will hear a different sound when the phase is reversed, for example. The reversed phase may sound fuller and more truthful. That is because there is a cancellation of frequencies within the ear when the external sound from the headphone mixes with the sound directly conducted to the ear. "Flipping the phase" can make the effect less noticeable.

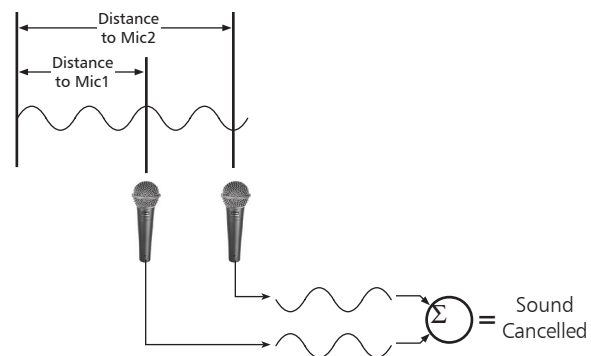

Figure 4-2 Phase Cancellation Effect

Another time when phase reversing can be helpful is in mixing multiple microphones that are within each other's coverage areas. The "crosstalk" between mics may come through different delays due to the differing distances from the sound. These sounds may

Using the 207D

tend to cancel out in the mix. You may get a “nasal” or hollow effect when all mics are on. Changing the polarity of one or more mics will often clear up the problem. It is always worth the time to experiment with mic polarity.

4.3.3 USING THE PAD

An input pad is nothing more than a resistive attenuator that drops the level coming from the input jack. Its purpose is to give you a way of preventing overload of the preamp when incoming signals become excessive. Another purpose is to change the preamp’s mic input into a line input.

In the 207D, we provided a pad of 20dB. That means when the pad is on, the net gain of the preamp is 20dB lower than normal. You will almost never need the pad unless you are using a high level microphone on a high level source (e.g., kick drums). If you have brought the GAIN all the way down and you still have an excessive output level then switch on the pad. You can then readjust the gain as desired.

4.3.4 USING LOW CUT

In the practical world, mics pick up all sorts of unwanted low frequencies such as hand noise, wind rumble, or lectern thumps. We designed into the 207D a very effective way of cutting out these low frequencies while maintaining a sense of normal low end response. Switching on the LOW CUT FILTER rolls off all frequencies below 70Hz at 12dB per octave but places a slight compensation around 120Hz to improve the low end phase distortion and perception of remaining bass. We first offered this cutoff shape with our Model 107 tube mic preamp and it received tremendous acclaim from vocalists and recordists alike. So, not wanting to waste a good thing, we carried it forward to the Model 207D.

Use the LOW CUT filter whenever you need it. However, please try going without if whenever possible. Even though it is outstanding as a rumble fixer, you will notice its presence. We suggest, as a matter of good practice, that you always try isolating the mic from unwanted vibrations instead of summarily switching in the LOW CUT filter.

4.3.5 USING MicLim™

MicLim™ works best on microphones having an impedance of 50 ohms or higher. That includes just

Figure 4-3 LO CUT Response

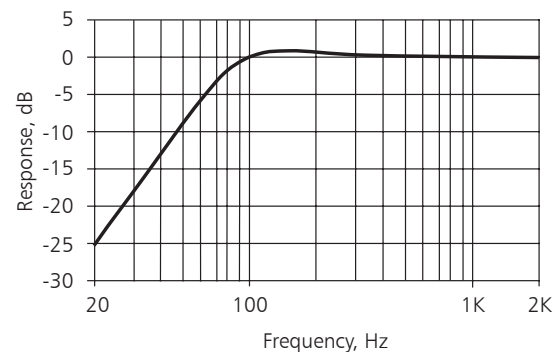

about every powered and passive microphone in existence. Additionally, the use of phantom power in no way inhibits the performance of MicLim™.

All you have to do is turn MicLim™ on and it will instantly become armed. Nothing will happen, however, until an audio peak approaches clipping: then the limiter will act on the microphone signal to prevent the peak from reaching the clip point. Whenever the limiter hits a peak, the yellow LIMITING light will flash.

There are no special rules about making MicLim™ work for you. The concept is simple: run the preamp gain at a point where the peaks indicated on the Headroom Meter only reach the MicLim™ threshold infrequently or unexpectedly. The great advantage of operating in this manner is to keep the audio signal far above the noise but fearing no distortion should the sound level suddenly increase. Recording this way can give you an uncanny sense of dimension because the background will have no audible noise, even at high monitoring levels. For those who will send this 207D’s output to a digital audio workstation, the greatest benefit is maximizing the use of the quantum dynamic range. The closer to the “top” you digitize a signal, the more digital resolution you get. You lose 1 bit of digital for every 6dB under maximum, so keeping the signal “up to the top” guarantees the best digital audio.

By now it may be apparent that if you deliberately increase the preamp gain until peaks frequently drive MicLim™ to limiting, you could obtain a very dense output level by bringing the average signal so much

Using the 207D

closer to the peak ceiling. Although it is certainly possible to operate MicLim™ in that fashion, and often the effect will be desirable, we recommend the use of restraint. MicLim™ was designed to be fast and unobtrusive for protection against accidental overloading, especially with voices. You may find the fast speed of this limiter too aggressive for general purpose effect limiting. Your favorite studio compressor/limiters can still be put to good use.

If you're not sure about whether to use MicLim™, just use it. If you never need it then it won't have any effect at all. But when that unexpected peak comes along, Bam! You're saved.

4.4 USING WORD CLOCK

4.4.1 External WC

Many applications require that your digital audio source be synchronized or "clocked" by a master clock source. The master clock may come from your workstation's interface electronics, house sync, or a local stand alone word clock generator. In either case, you need to be sure the 207D has been properly connected to your word clock source. Fortunately, the 207D is provided with a highly tolerant clock input circuit that makes level and impedance relatively uncritical. As long as the clock source delivers from 1 to 5 volts peak-to-peak between the frequencies of 44.1 and 96kHz, the 207D will normally lock up. If you can't seem to get a lock, make sure the external clock mode is selected on the front panel.

4.4.2 Internal WC

In cases where you don't need to use an external word clock reference, the 207D has its own low jitter internal word clock generator. You need to select the desired sampling rate at the 207D's front panel. Frequencies of 44.1, 48, 88.2, and 96kHz are provided. If you are not getting any digital output, then you should first double check this setting.

The Model 207D does not source out its internal word clock, so you won't be able to use it for a master clock.

4.4.3 Multiple 207D Clocking

If several 207D's are to be used at the same time, you need to know whether the digital inputs to your mixer or workstation are synchronous or

asynchronous. Most digital consoles and recorders require synchronization of all digital audio sources. That means you need to distribute word clock to all 207D's from the single word clock source. You will need a word clock distribution amplifier to do that.

CLOCKING MULTIPLE 207D'S

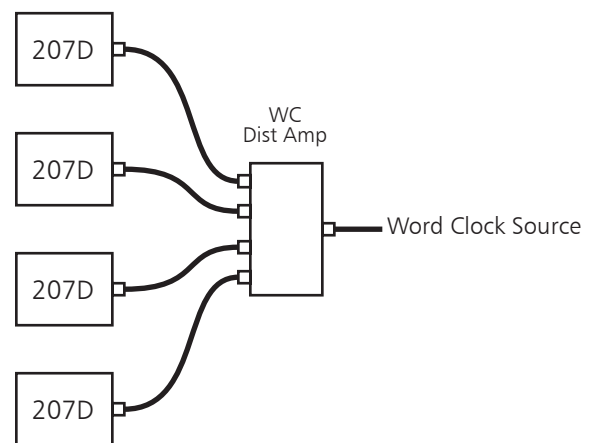

4.5 USING DIGITAL AUDIO (AES3 & S/PDIF)

The front panel meter is directly calibrated to the digital audio headroom (and analog as well). It is important to leave some headroom at all times. Causing the headroom meter to hit the top of the scale will result in distortion. Even if you can't hear the distortion in the analog output, your digital recording medium or workstation will almost certainly add enough digital artifacts to make the distortion audible in the mix. This is a lesson not so much about the 207D as about digital editing and processing in general. It is always a great idea to leave the top 6dB of the digital dynamic range open to allow for overshoots that will occur later when passing through equalization and other processing such as codecs.

4.6 REPLACING YOUR CONSOLE'S MIC PREAMPS

The most basic application for the 207D is to provide an upgrade over the microphone preamplifiers in your mixing console. We are not insinuating that your console's preamps are no good, just that the Model 207D is better. If you did not know that, you probably would not have bought your 207D.

Consoles are built for functionality at a target price point. Lower priced equipment may have a huge array of facilities rivaling more expensive equipment. However, everything inside is designed as cheaply as

Using the 207D1

humanly possible, even to the extent of compromising sound quality. Even the inordinately expensive world class studio desks place a compromise on the mic preamps they build in. Good preamps require a lot of circuitry that just won't fit inside. Let's not forget, too, that a really great mic preamp requires its own ingenious circuitry and design. It is not surprising that of all the parts of a mixing desk, it is mainly the mic preamps that ever get replaced.

No matter how noble the intent, there is one dilemma that can thwart you in successfully bypassing the mic pre of some consoles. You must become aware of this problem in order to deal with it. We have been instructing you to connect the Model 207D to the LINE inputs of your console or other equipment, and NEVER connect it to a mic input. **The problem is that when connecting your 207D to your console's line inputs, you may actually be connecting to mic inputs and not knowing it.** That is because many consoles simply put a heavy pad in front of the mic pre input to make a line input out of it. The whole microphone preamplifier circuit is still in line and carrying your signal! You have to suffer the sonic limitations of the console's mic preamps and that may mask out the benefits of using the 207D.

There is a solution if your console has pre-fader inserts. You can plug the output of your 207D into the console's insert jack, bypassing the channel's whole front end. That may eliminate the equalizer and any other processing provided there, but it may nevertheless be an excellent solution. You will be able to have tracks that sound incredibly alive and dimensional not needing much additional processing anyway.

When driving a console's insert jack, you may need to build or obtain a special insert cable, usually in the form of a "Y" cable. That is because the insert jacks of low cost consoles are usually 1/4" stereo phone jacks that carry send and return as unbalanced lines using tip and ring, similar to the Model 207D's insert jack. You should consult your console's manual for instructions on connecting outboard equipment to the insert jack. The 207D's output can easily adapt to driving an unbalanced insert. You simply set the operating level switch to whichever setting is closer to the insert's operating level. It will usually be -10dBV for home studio mixers and +4dBu for fully professional

studio desks.

4.7 BYPASSING THE CONSOLE ALTOGETHER

When you are laying down tracks, why even involve your mixing console? Maybe you had to do that to be able to use console's the mic preamps, but with the 207D you can go direct to tape or disk or DAW and eliminate an entire layer of electronics. Usually, effects and equalization are best added later during mixing.

REPLACING THE CONSOLE'S MIC PREAMPS

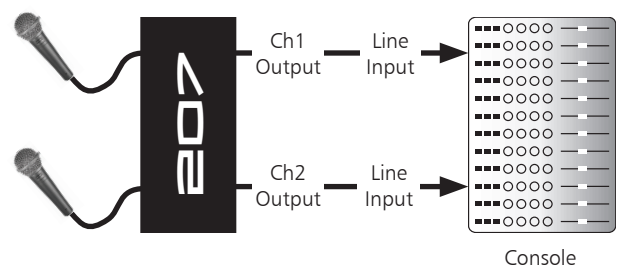

Simply driving your recording electronics directly from the 207D gives you the best initial sound tracks possible. Most studio recording sessions lay down 1 to 4 tracks at a time, session by session, until the needed tracks have all been created. If you have one or two Model 207D's, you would have enough outboard preamps to handle most recording sessions.

The main trick is to set the preamp gains low enough to prevent overload, then record straight through without riding gain. This gives you natural levels to work with later. In mixdown you can compress tracks and ride gain all you want. With MicLim™, you can run all of the recording levels higher, using higher mic gains, and not worry about overload. When MicLim™ acts, it is fast and smooth. Most of the time you won't notice it work. You will truly appreciate having hot, clean and quiet tracks at mixdown. You will be amazed at the quality you can achieve and how easily it comes to you with great initial tracks. You will find yourself messing around with EQ and compression far less because the sound won't need all that fixing. Whatever artistic or production effects you want to use will work better and be easier to accomplish.

4.8 USING THE 207D FOR STEREO RECORDINGS

Stereo recordists will find the Model 207D perfect for

Using the 207D

their work. The low noise and highly detailed, open sound of the 207D delivers breathtaking results. All expert recordists know the techniques we're about to show you. However, others may find them interesting to learn about.

SPACED-PAIR TECHNIQUE

About the most obvious technique is using two microphones spaced apart some distance and pointed directly at the sound source. The spacing between mics and distance from the source depends on the width of the sound platform you want to include.

With spaced-pairs there will be a phase difference between the two mic outputs. This can cause cancellation of certain frequencies. An accepted compromise is called the 3:1 Principle. According to this principle, you should place the microphones 3 times as far apart as their distance to the front of the sound source. With such a wide separation of the mics, omnidirectional types are called for. Otherwise you might exclude the whole center of the sound stage from adequate coverage.

X-Y TECHNIQUE

Also called a "COINCIDENTAL PAIR", this technique employs two cardioid pattern microphones. The grills of each microphone should be placed as close together as possible without touching. Each microphone should be positioned at right angles to each other. Use the intersection of this 90' angle as a sight, and aim toward the middle of the sound source (see illustration on subsequent page). The microphones should be of the same make and model.

An advantage of this technique is better rejection of back-side room noises that include the audience and slap-back or echo. The X-Y technique is often used to record noisy live events.

M-S TECHNIQUE

Another popular stereo micing technique is referred to as the "Middle-Side" technique. This method combines two microphones of different response patterns positioned along the same horizontal plane. One is a cardioid mic which is aimed directly at the front-center of the orchestra. The second microphone has a figure-eight pattern positioned so that the axis of the lobes are lateral, facing left and right. An elec-

tronic matrix circuit processes both microphones and provides Left and Right channel outputs. This method vectorially extracts the left and right channels from the sum and difference signals (the middle cardioid and side figure 8 patterns).

Generally, M-S is practiced with specially built microphones that are sold with the M-S processor. The mic preamps are normally integral to the processor. However, certain M-S processors allow you to use external mic preamplifiers so you could introduce a Model 207D. When doing so, just be sure to set the gains of the two channels reasonably close and do not change them during the recording. With M-S recording, the stereo separation will change if either the middle or side gain should be changed.

BINAURAL TECHNIQUE

This attempts to record sound like the ears hear it using two closely spaced microphones either worn on a person's head near the ears, or located inside of a dummy head with simulated ear canals. It attempts to capture sound waves with the refractions that occur naturally due to the shape of the head. These days, binaural microphones are commercially available that come with a matched dummy head. However, many incredible recordings have been made with two small identical omnidirectional mics mounted to eyeglass frames.

For those recordists that do much of their work in binaural, the Model 207D is perfect. Its low noise and clear open sonic quality generate recordings that are incredibly realistic and beautiful, catching all the nuances and details.

FURTHER READING

There are more microphone techniques than we can cover in this manual. Many reference books exist that go into great detail. Here are a few: "Modern Recording Techniques" by Huber and Runstein, "Sound Reinforcement Handbook" by Gary Davis and Ralph Jones, and "Introduction To Professional Recording Techniques" by Bruce Bartlett. If you are one who enjoys the challenge of recording, we believe you will truly appreciate the outstanding performance benefits afforded by the Model 207D.

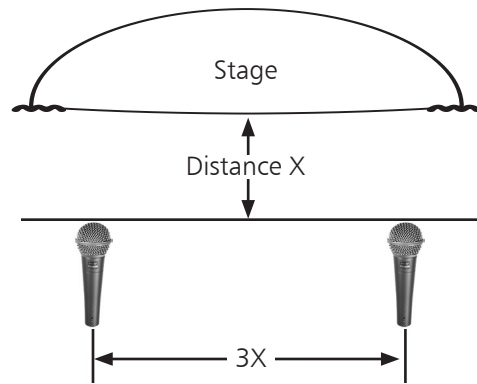

Figure 4-4 SPACED PAIR 3 to 1 TECHNIQUE

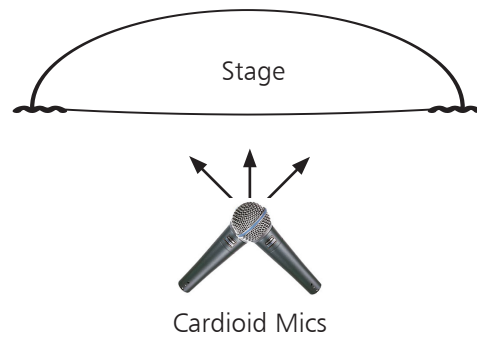

Figure 4-5 X-Y TECHNIQUE



Figure 4-7 BINAURAL MIC

(Example: Neumann KU-100)

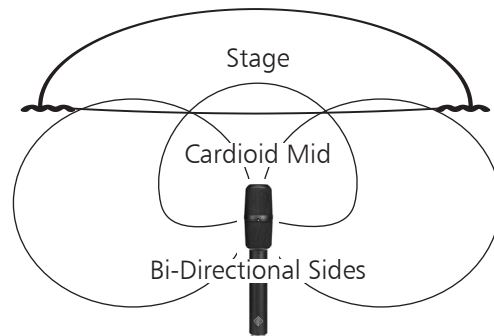

Figure 4-6 M-S TECHNIQUE

5.0 Warranty & Service

5.1 Limited Warranty

PERIOD

One year from date of purchase

SCOPE

All defects in workmanship and materials. The following are not covered:

- a. Voltage conversions
- b. Units on which the serial number has been defaced, modified, or removed
- c. Damage or deterioration:
 1. Resulting from installation and/or removal of the unit.
 2. Resulting from accident, misuse, abuse, neglect, unauthorized product modification or failure to follow instructions contained in the User's Manual.
 3. Resulting from repair or attempted repair by anyone not authorized by Aphex Systems.
 4. Occurring from shipping (claims must be presented to shipper).

WHO IS PROTECTED

This warranty will be enforceable by the original purchaser and by any subsequent owner(s) during the warranty period, so long as a copy of the original Bill of Sale is submitted whenever warranty service is required.

WHAT WE WILL PAY FOR

We will pay for all labor and material expenses for covered items. We will pay return shipping charges if the repairs are covered by the warranty.

LIMITATION OF WARRANTY

No warranty is made, either expressed or implied, as to the merchantability and fitness for any particular purpose. Any and all warranties are limited to the duration of the warranty stated above.

EXCLUSION OF CERTAIN DAMAGES

Aphex Systems' liability for any defective unit is limited to the repair or replacement of said unit, at our option, and shall not include damages of any other kind, whether incidental, consequential, or otherwise.

Some States do not allow limitations on how long an implied warranty lasts and/or do not allow the exclusion or limitation of incidental or consequential damages, so the above limitations and exclusions may not apply to you.

This warranty gives you specific legal rights, and you may also have other rights which vary from State to State.

5.2 SERVICE INFORMATION

If it becomes necessary to return this unit for repair, you must first contact Aphex Systems, Ltd. for a Return Authorization (RMA number), which will need to be included with your shipment for proper identification. If available, repack this unit in its original carton and packing material. Otherwise, pack the equipment in a strong carton containing at least 2 inches of padding on all sides. Be sure the unit cannot shift around inside the carton. Include a letter explaining the symptoms and/or defect(s). Be sure to reference the RMA number in your letter and mark the RMA number on the outside of the carton. If you believe the problem should be covered under the terms of the warranty, you must also include proof of purchase. Insure your shipment and send it to:

Aphex Systems, Ltd.
11068 Randall Street
Sun Valley, CA. 91352
PH: (818) 767-2929 FAX: (818) 767 -2641

6.1 GENERAL SPECIFICATIONS

OPERATING LEVEL		+4dBu	-10dBV
Switch Setting:			
MIC INPUT			
Connector:	XLR-3F	Same	
Type:	Transformerless, NPN active balanced	Same	
Balanced:	2K Ω nominal	Same	
Maximum Level:	0dBu	Same	
CMRR:	Greater than 70dB @ 60Hz	Same	
Nominal Preamp Gain:	20 to 65dB minus OUTPUT TRIM loss	8 to 53dB minus OUTPUT TRIM loss	
INSTRUMENT INPUT			
Connector:	1/4" Phone Jack	Same	
Type:	Unbalanced JFET Amplifier	Same	
Input Z:	1M Ω	Same	
Maximum Level:	10VRMS	Same	
Nominal Preamp Gain:	-infinity to 65dB minus OUTPUT TRIM loss	-infinity to 38dB minus OUTPUT TRIM loss	
OUTPUT			
Connector:	XLR-3M and TRS 1/4" phone jack	Same	
Type:	Impedance Balanced (may be used unbalanced)	Same	
Output Z Balanced:	XLR:66 Ω – TRS:1200 Ω	Same	
Output Z Unbalanced:	XLR:33 Ω – TRS:600 Ω	Same	
Nominal Level:	+4dBu	-10dBV (-7.8dBu) Unloaded	
Maximum Level:	+21dBu Unloaded	+6.75dBV Unloaded	
Output Trim:	0 to -12dB	0 to -12dB	
AUDIO			
Frequency Response:	+0,-0.5dB 30Hz-30KHz	Same	
EIN:	-129dBu (Input Shorted)	Same	
Crosstalk:	10Hz - 22kHz, -79dB or better	Same	
THD:	10Hz - 22kHz @ -11dBfs , <0.18%	Same	
Tube Type:	12AT7/ECC81 Dual Triode	Same	
INSERT			
Connector Type:	1/4" TRS Phone Jack	Same	
Send:	Tip	Same	
Return:	Ring	Same	
Nominal Operating Level:	-10dBV (316mVRMS)	Same	
Point of Insertion:	Between front-end and Tube Output Stage	Same	
DIGITAL			
Output Connector Types:	AES3: XLR; S/PDIF: RCA Jack		
Word Clock In Connector Type:	BNC Jack		
Internal Sample Rates:	44.1, 88.2, 48, 96kHz		
Digital Resolution:	24-Bits		
External Clock Lock Range:	32 to 96kHz		
S/PDIF Output Level/Impedance:	1Vp-p into a 75 ohm load, 2Vp-p unloaded		
Ext Word Clock Level:	<1Vp-p to over 5Vp-p acceptable		
OTHER SPECS			
Power Supply:	Internal, 100-240V~ 50-60Hz, Using IEC Standard Power Receptacle		
Power Consumption:	12 Watts		
Fuse:	Internal, not user serviceable		
Dimensions:	19" W x 1.75" H x 8.25" overall depth (482.6mm W x 445mm H x 209.6mm overall depth); depth behind front panel: 7.5" (190.5mm)		
Net Weight:	Rack-mounted, 6lbs (2.73kg)		
Shipping Weight:	9lbs (4.1kg)		

All specifications are subject to change without notice.

Specifications

6.2 ARCHITECTURAL SPECIFICATIONS

Basic Description

A two-channel electronic preamplifier for microphones and instruments comprising a transformerless balanced microphone input and a high impedance unbalanced Instrument input for each of the two channels. The preamplifier shall comprise a Reflected Plate Amplifier tube-type transformerless output stage. The preamplifier shall further comprise an operating level switch to select between nominal output levels of +4dBu and -10dBV. The two preamplifier channels shall be operable independently. There shall be two industry standard analog output jacks per channel, an XLR 3-pin male, and a 1/4" TRS phone jack. In addition to the analog outputs, a 24-Bit digital audio S/PDIF output from an internal analog-to-digital converter shall be provided. Additional specifications are stated below.

Microphone Input

The input jack shall be a standard XLR-type 3-pin female. The input impedance shall be nominally 2000 ohms. All normally operated controls for the mic input shall be placed on the front panel. The mic preamp shall comprise the following features: 1.) Selectable +48VDC Phantom Power; 2.) Selectable Polarity; 3.) Selectable 20dB Pad; 4.) Selectable 70Hz 12dB/Octave Low Cut Filter; 5.) Selectable Peak Limiter; 6.) Continuous Gain Control. The selectable peak limiter shall be a type that limits the mic signal before any amplification to prevent input overload. The input stage shall be transformerless and actively balanced. The preamplified microphone signal shall be sent through an INSERT jack to the output stage to facilitate the use of outboard signal processing.

Instrument Input

The input jack shall comprise a 1/4" phone jack. The input impedance shall be 1 megohms. The input stage shall comprise a low noise JFET integrated circuit amplifier.

Insert Jack

A 1/4" TRS phone jack shall be provided at the rear panel for inserting outboard signal processing for the microphone input only. The insert jack shall comprise an unbalanced send and an unbalanced return that operate at nominal -10dBV levels. The point of insertion shall be between the microphone preamplifier and the tube output stage.

Digital Outputs and Sample Rates

The digital sample rate shall be selected from internal frequencies of 441., 88.2, 48, and 96kHz. Additionally, an external word clock input shall be provided to receive clock frequencied from 32 to 96kHz. The outputs shall be both AES3 on XLR and S/PDIF on RCA.

Physical Properties

The device shall be packaged in an all metal chassis measuring 19" (482.23mm) wide, 1.75" (44.42mm) high, with an overall depth of 8.25" (210mm). Depth behind the front panel shall be approximately 8" (203mm). The device shall have a net weight of approximately 6lbs. (2.73kg) and is capable of mounting in a standard electronic equipment rack.

Power

The unit shall have a self contained power supply operating from the ac line. Primary voltage, connectorization and agency listings shall be appropriate to meet local requirements.

Appendix A: Balanced and Unbalanced Lines and Operating Levels

Interfacing all types of equipment with balanced and unbalanced lines and can sometimes be troublesome. First you have to somehow connect balanced to unbalanced and then you have to deal with different levels. This tutorial will teach you about the principles of balanced and unbalanced lines, wiring standards, and how to effectively interface them.

Standards

Professional audio equipment usually comes equipped with inputs and outputs that are balanced using 3-pin XLR connectors and sometimes 1/4 inch phone jacks as well. This equipment most often is designed to operate at +4dBu, a professional industry standard. That translates to a magnitude of 1.23 volts RMS (Root-Mean-Squared).

Consumer gear has unbalanced I/O as standard, usually on RCA jacks. The normal operating signal level follows the IHF (Institute of High Fidelity) standard of -10dBV, or 0.316 volts (316mV) RMS. Converting to dBu dimensions, this works out to be the same as -7.79dBu. There is therefore a difference of 11.79dB between pro and consumer operating levels.

Grounding

There is the notion that some kind of earthly "ground" exists out there that sinks all the noise and acts as some kind of a shield. You see wires connected to ground rods and water pipes that are supposed to get a good ground. This is not a correct interpretation of grounding from an audio standpoint. Proper grounding of equipment and wiring is important and you will gain a better understanding of that as you read along.

Balanced -vs- Unbalanced

Every audio signal is connected through a circuit. The circuit must contain two conductors to create a complete return path. In other words, a signal voltage is conducted to a piece of equipment by injecting a current into a wire. That current has to flow to the destination through the wire and return back to the source through another wire. Since audio is an alternating voltage, swinging through negative and positive polarity, the current through the two conductors changes direction each alternate half cycle. Which

wire is the source and which is the return alternates accordingly. In this regard, balanced and unbalanced lines are the same. They both need two conductors.

What makes a system unbalanced is when one of the wires is formed into a tube that wraps around the other conductor, without touching it, such that the outer conductor can be said to "shield" the inner conductor. This describes all of the coaxial cable used for video, cable-TV and radio as well as most of the high fidelity audio cables.

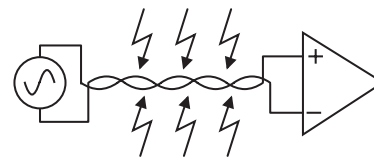

Figure 1 Balanced Line Model

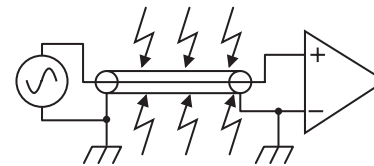

Figure 2 Unbalanced Line Model

Balancing

If both conductors are identical insulated wires that are twisted together, then they form a balanced line. This describes telephone lines, microphone cables, and most professional audio cables. Typical balanced cables include an additional shield wrap around the twisted pair, but this is not strictly required for balanced lines to work properly.

Many people, because they have more experience with unbalanced wiring, think that balanced is confusing. Believe it or not, balanced lines are really easier to understand than unbalanced. There is no grounding issue with balanced, and the way it works is perfectly natural and simple. Balancing naturally rejects hum and noise and eliminates all sorts of complications in interfacing.

Balanced transmission works something like this.

Appendices

Your balanced input stage looks at the two wires and detects only the potential (voltage) difference between them. Anything that is the same on the two wires (for all practical purposes as seen measuring from ground) is called a common mode signal and is cancelled out by the differential amplifier. Figure 1 illustrates how the hum is induced into both wires equally and therefore is cancelled out.

Since the balanced line has wires that are twisted together, each wire tends to pick up the same amount of induction from external sources. Induction will create no significant voltage difference between the wires, hence the noise (or hum) will not be picked up by the differential input stage.

It can be seen that the signal generator driving the twisted pair will cause a difference between the wires, and that signal will be readily picked up by the differential input stage. One of the beauties of the balanced line is that it is completely independent from ground. Nothing is connected to ground at all, nor does it care about ground. Nevertheless, most professional cable has an overall shield wrap that is intended to be connected somehow to ground. You may well ask why, and the answer is less than glorious. Simply, nothing is perfect, not even balanced cable. Under some circumstances the shield can overcome extreme interference problems that can't be adequately rejected by the twisted pair alone. Things like 2-way radios, television transmitters, and light dimmers can induce very heavy interference that may be reduced by shielding. You are going to find virtually all balanced cables include a shield so you need to deal with it, even if it is not actually needed. That subject will be addressed a little later.

Unbalancing

Unbalanced wiring works a little differently. Figure 2 shows the basic plan. In this case, the wires are not twisted, they are coaxial. The unbalanced input stage is somewhat like the balanced input stage because amplifies a difference signal, but this time it is the difference between two non-symmetrical conductors. To make things even less symmetrical, the outer conductor is connected to ground at both ends. The principle is that the outer shield conductor shields the inner conductor from induced noises. This can only work well if the cable is relatively short and the ground at each end of the cable is somewhat equal,

i.e., there is no "grounding difference" that can cause current to flow through the shield conductor. Grounding difference is a serious problem in studios, because often the equipment grounds are connected to power outlet grounds, and there can be a significant difference of ac voltage between alternating wall outlet grounds. For this reason, unbalanced systems can sometimes never be made hum free, and just changing one piece of equipment in a studio can cause hum to appear somewhere else. When you are using unbalanced gear, it is a very good procedure to power all your equipment from one large power isolation transformer. At the very least, make sure all equipment is powered together off the same distribution panel circuit (same circuit breaker).

Appendix B: Dealing With Grounds and Hum

Ground Loops

Many people equate this term with hum, and that's just about the bottom line of it. If you have a ground sensitive system, like unbalanced audio equipment for example, then hum will result from ground currents that flow from the ac power system. It is sometimes very difficult to isolate and stop ground currents between unbalanced equipment, but it is quite easy to clean up balanced gear. That's why pro gear is always balanced! The cost of balancing is that of more expensive connectors, cable, and electronics but the cost is worth it when you depend on your audio quality. That's why the Model 207D is equipped with a fully balanced I/O. Now that we've sold you on only using really expensive pro gear, lets show you how to get away with the really cheap stuff! At least from the standpoint of killing ground hum.

A ground loop is an ac current that has become routed through your audio ground system. The current comes mainly from ground potential differences that exist between different wall outlets that return to opposite phases at the power distribution panel. Secondly, however, many pieces of equipment contain line filters and transformers that leak a small amount of ac power into the chassis and ground return.

You may once have had the experience of getting zapped by touching two pieces of gear at the same time. That illustrated the ground loop effect - -

6.0 Appendices

straight through you! No matter what you do, you may not be able to prevent some of your equipment from generating ground currents. The most likely culprits are digital products because they use switching power supplies that require heavy line filters to prevent conducted EMI from going out of the box. Filters so employed very often take the ground leakage current right up to the UL safety limits. Although it won't kill you, that is a lot of ground loop current for audio cables to handle.

There are basically three ways to attack the problem of a ground loop. First is to eliminate it from its source, and the second is to re-route it through another path. The third is to balance out your unbalanced audio interfaces.

Identify the Sources

A good way to identify grounding problems is to use a multimeter to check the ac voltage between the chassis of your various gear when no audio cables are hooked up and all gear is plugged in and switched on. Just start touching the two probes to the metal chassis of different pieces of gear. Ideally, you should always see zero volts. Warning! You may see as much as the whole line voltage between two different chassis! It does happen. This voltage between chassis will be responsible for your ground loop problems. If you find there is more than about 1 volt between equipment grounds, you should start looking for a remedy.

Commonize the Power

Try plugging all of your equipment into the same outlet strip. Get one that has enough outlets in one strip or string more than one together. Of course, you need to make sure you don't overload the one ac circuit your strip is plugged into. If the load is too great for one circuit, use a second or third circuit that is tapped off the same 120 volt phase in your distribution panel. That means all outlets should be on odd or even numbered circuit breakers. That's because, as you go down the column, the circuit breakers tap into alternating legs of your incoming electric power. Be sure you're always on the same leg. You can tell you're on the same leg by measuring the ac voltage between the hot slots of the different outlets you've chosen. It should be very low or zero. That will remedy 50 percent of the cases.

Check the Cord Polarity

For products that have 2-wire power cords, try reversing one of the power cords in the socket. That may reduce the ground current generated by the internal electronics of the offending gear.

Redirect Ground Loops

Sometimes it just comes down to brute force grounding. That means providing such heavy, low resistance, ground current paths that little current is left to flow through your audio grounds. You can try adding heavy gauge, for example 12 gauge, copper wire from chassis to chassis. You will need to locate a metal screw that solidly binds to the metal chassis of the gear. You may even need to drill a hole through the chassis and install a screw yourself. Equipment in rack shelves can have their chassis grounded to the metal rack frame by a heavy wire and the frame itself can act as a brute force ground. You just have to try everything you can think of. Usually a combination of all these methods will be needed to completely clean up a badly humming audio system.

Balance Out the Audio

Remember, balanced lines are inherently hum free. If you can balance out your unbalanced equipment, you will be able to stop the hum.

Pseudo Balancing

You will find in Appendix D an interconnecting method called Pseudo Balanced. This works when connecting an unbalanced output to a balanced input. This breaks up the ground loop by requiring the shield to be grounded only at one end. For best results always ground the shield only at the receiving end.

Level Interface Units

Aphex manufactures the Model 124A Level Interface box which is designed to electronically convert two unbalanced inputs and outputs into two balanced inputs and outputs, and at the same time translate the -10dBV IHF unbalanced levels to the pro +4dBu balanced levels. This cost effectively gives your non-professional unbalanced equipment a fully professional I/O equal to the world's best pro audio gear. Seriously consider putting one of these on each unbalanced piece of gear you use. When appropriate, you may alternatively chose the Aphex Model 228 8-channel -10dBV unbalanced to +4dBu balanced converter.

Appendices

Avoid Transformers

The use of balancing transformers is an option, but you will invariably lose audio quality due to transformer limitations. Try everything else first.

Appendix C: Proper Wiring Techniques

A true balanced line should be used wherever your equipment allows. Use "twisted pair" shielded cable. For unbalanced wiring you should use high grade, low capacitance shielded wire for best results. If you have an unbalanced output but have a balanced input, the "pseudo-balanced" configuration may help deal with ground loop hum. This method and others are illustrated in Table 2.

CONNECTOR WIRING STANDARDS

The 3 pin XLR, 1/4" (63.5 mm) TS mono phone and the 1/4" (63.5 mm) TRS stereo phone are the most commonly used line level connectors in pro audio. Less common is the use of the "RCA" phono jack, which is essentially a consumer type connector. The XLR and the TRS are three conductor and are used for balanced connections. The TS and the RCA are two conductor and are used for unbalanced connections.

In addition to the three main contacts on an XLR there is also a grounding lug contact. This lug is connected to the connector's case (shell). In all Aphex products audio ground and chassis ground are one and the same. Aphex products that use XLR connectors tie Pin 1 to the XLR case automatically. **Therefore it is not necessary to use the XLR case-ground lug.** This also makes possible the use of XLR ground drop adapters (see Note 3).

TABLE 1: The wiring convention shown is now standardized in 17 countries including the USA. Please note that any equipment that still uses Pin 3 as positive on XLR connectors is not adhering to the standard.

THE PIN 1 DILEMMA AND HOW IT AFFECTS CABLE SHIELD CONNECTIONS

The three main contacts on an XLR (or TRS) and the accepted wiring assignments shown below are

only part of the picture. The standard for terminating ground is Pin 1 (Sleeve). But which ground? It could be connected to audio signal ground or chassis ground depending on the method of grounding used by the equipment manufacturer. In all Aphex products audio ground and chassis ground are one and the same at all I/O jacks. This is just good, common sense engineering practice (which is what you would expect from us, course). Unfortunately, many products are designed so that the noisy currents from the shield drain into signal ground instead of chassis ground. This practice creates a real hum and noise problem for end-users. The appropriate overall grounding scheme of an audio system would be a lot easier to predict without this problem.

The standard balanced line wiring recommendation from Aphex Engineering is this: In the majority of cases maximum noise rejection occurs when the shield is connected to the input ground only (especially in locations with high levels of RFI). That means the sending end shield should be left disconnected.

However, if you already have cables with the shield connected at both ends, go ahead and try them out. If you are connecting a fairly simple audio system it may be fine as is.

A word on optional shield connections: Connecting the cable shield of a balanced line at both ends creates unnecessary ground loops which may carry noise and hum currents that can be amplified. Connecting the shield only at the sending end (instead of the receiving end) may exaggerate common mode noises at the receiving input stage. It can actually increase RFI and noise more than having no shield at all. Because of the "Pin 1 Dilemma" (mentioned above) you may be forced, in some situations, to experiment with how the cable shield is connected to ground to eliminate a pesky hum or radio interference problem. It might be good to try XLR ground drop adapters (see Note 3) as a method of trying these conflicting methods out and being able to change easily if necessary.

IMPEDANCE

Regardless of inaccuracies, it has become more or less standard over the years to refer to balanced

TABLE 1 - BALANCED & UNBALANCED CONNECTOR WIRING STANDARDS

3-Pin XLR	1/4" TRS Phone	Standard Wiring Convention (Balanced)
Pin-1	Sleeve	Ground/Shield (Earth, Screen)
Pin-2	Tip	Positive (Signal, High, Hot)
Pin-3	Ring	Negative (Signal Reference, Return, Low, Common)
1/4" TS Phone	RCA	Standard Wiring Convention (Unbalanced)
Tip	Center Pin	Positive (Signal)
Sleeve	Shell	Ground/Shield (Signal Reference/Return)

lines as low impedance and unbalanced lines as high impedance. The fact is, however, that both balanced and unbalanced lines are operated at low impedance in modern practice owing to the fact that all output stages have become low impedance. A few exceptions might be outputs from passive mixers, instrument pickups, electric guitars and some keyboard synthesizers. It is generally ideal to drive any audio line from a low impedance and receive into a high impedance. Generally, a minimum 1: 10 ratio is possible. This is called "bridging". This has become modern practice and all balanced inputs are normally running 10K ohms or higher impedance. Because of these developments, it is now no longer as critical to consider impedance when dealing with interfacing pro line level equipment (impedance "matching" is mostly a requirement of the past).

A word on impedance and interfacing adapters:

If you are connecting between two line level devices and they have different connectors (example: 1/4" phone to XLR or vice-versa), you do not need to use an impedance matching transformer. With very few exceptions you are strictly dealing with a difference in connector types and should only use hard-wired adapters (or cables) for this situation.

APPENDIX D: Standard Cable Wiring

In relation to 1/4" phone jacks, you may see the terms "TS" and "TRS" as abbreviations. Here is a what that

means: TS refers to the Tip-Sleeve or "mono" 2-conductor type and TRS refers to Tip-Ring-Sleeve or "stereo" 3 conductor type 1/4" phone connectors. This applies to jacks (female connectors) and plugs (male connectors).

Note: We recommend using only conventional 1/4" phone plugs with the Model 207D and with all other audio equipment. Professional patch bay cords using brass PJ055 telephone type plugs are designed only for patch bays and will not make proper contact with standard 1/4" phone jacks.

The following instructions show all the different ways you will probably ever need to hook up your 207D as well as any other equipment you may own. You will see that connecting balanced outputs to balanced inputs is ultimately simple and the same cable will work for all flavors of output stages.



Connecting a balanced output to an unbalanced input requires a little more knowledge and care. You should refer to your equipment manuals and determine the type of balanced output stage that is provided, then use the correct "transition cable" as depicted in this section. Improper transition cables can cause crosstalk, hum, and distortion problems within your system.

TYPES OF BALANCED OUTPUTS

Believe it or not, there are at least 5 types of balanced output stages in use today. They may be placed into two main classes: transformer balanced, and

Appendices

transformerless balanced, usually called “active balanced”. Transformer balanced outputs are becoming outdated because of their high cost and their sonic limitations. However, they can still be found on a lot of older equipment.

Within the transformerless class, there are several types of circuits that are used by different manufacturers. These different types of output circuits all look just about alike to any balanced line, but they act differently when driving an unbalanced line. You need to observe the proper cable wiring for each type of output circuit. We strongly recommend that you refer to your various equipment manuals to find out what is used in each case before hooking up to unbalanced lines.



When connecting a balanced output to a balanced input, however, you don't need to know what kind of balanced output you are dealing with. Simply treat it generically.

XLR to XLR



OK for Microphones

Standard store-bought cable. Shield grounded at both ends.

Positives: Good for microphones.

Negatives: May cause ground loops through the shield grounds if used to connect equipment together.



Preferred for Line Levels

Shield grounded at receiving end only.

Positives: Stops ground loops and reduces noise.

Negatives: None

PART 1: BALANCED OUT to BALANCED IN

1/4" TRS Phone to 1/4" TRS Phone Balanced Cables



OK

Standard store-bought cable. Shield is grounded at both ends.

Positives: Both ends are interchangeable.

Negatives: May cause ground loops through shield contacts.



BETTER

Custom cable. Shield is grounded at receiving end only.

Positives: Stops ground loops and reduces noise.

Negatives: Should be oriented so lifted shield is at sending end.

XLR to 1/4" TRS Phone Balanced Cables

From an Output

Female XLR



No Connect
Stops Ground Loops

To an Input
Stereo Phone Plug

From an Output
Stereo Phone Plug

No Connect
Stops Ground Loops

To an Input

Male XLR



PART 2: BALANCED OUT to UNBALANCED IN

It was mentioned that there are several types of balanced output stages in use today. The following diagrams show you how to properly unbalance each type of output. If you follow these instructions, you should have no problems.

Transformer Balanced Outputs

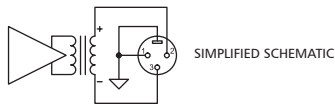

SIMPLIFIED SCHEMATIC

Unbalancing loses no output level. You retain full gain.

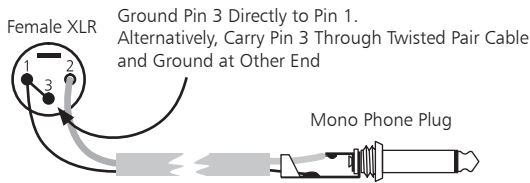

Ground Pin 3 Directly to Pin 1. Alternatively, Carry Pin 3 Through Twisted Pair Cable and Ground at Other End

Servo Balanced Outputs

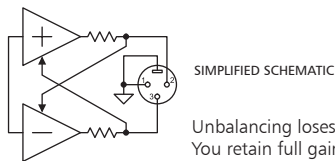

SIMPLIFIED SCHEMATIC

Unbalancing loses no output level. You retain full gain.

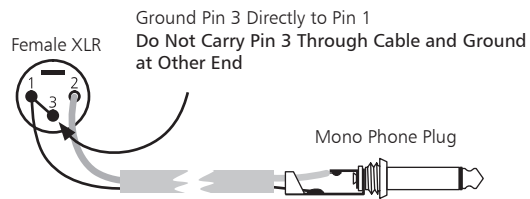

Ground Pin 3 Directly to Pin 1 Do Not Carry Pin 3 Through Cable and Ground at Other End

Voltage Balanced Outputs (Used on the 207)

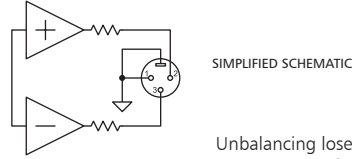

SIMPLIFIED SCHEMATIC

Unbalancing loses half the output level. You lose 6dB of gain.

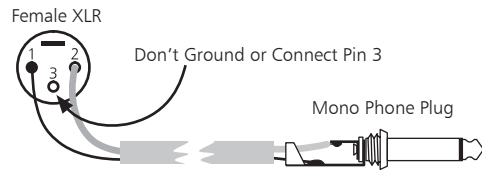

Don't Ground or Connect Pin 3

Impedance Balanced Outputs

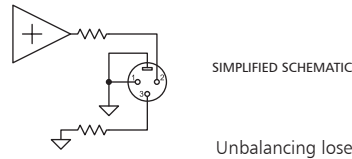

SIMPLIFIED SCHEMATIC

Unbalancing loses no output level. You retain full gain.

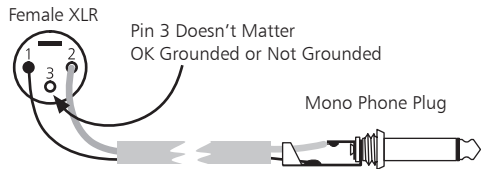

Pin 3 Doesn't Matter OK Grounded or Not Grounded

Appendices

PART 3: UNBALANCED to UNBALANCED

Standard Cable (Guitar Cord)



PART 4: UNBALANCED OUT to BALANCED IN

Standard Method

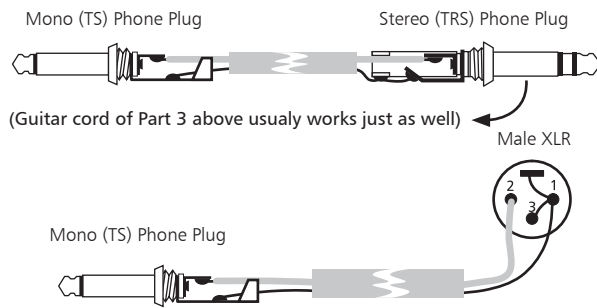

Enhanced Method (Pseudo Balanced)

Advantage: Reduced Hum and Noise Pickup

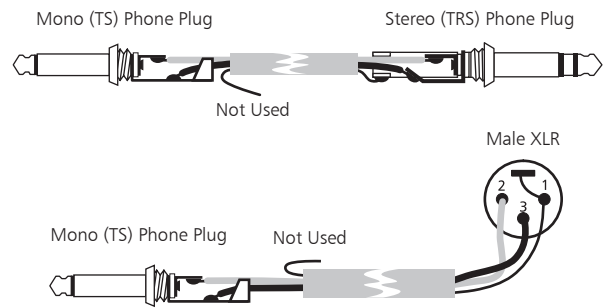

PART 5: "Y" INSERT CABLES

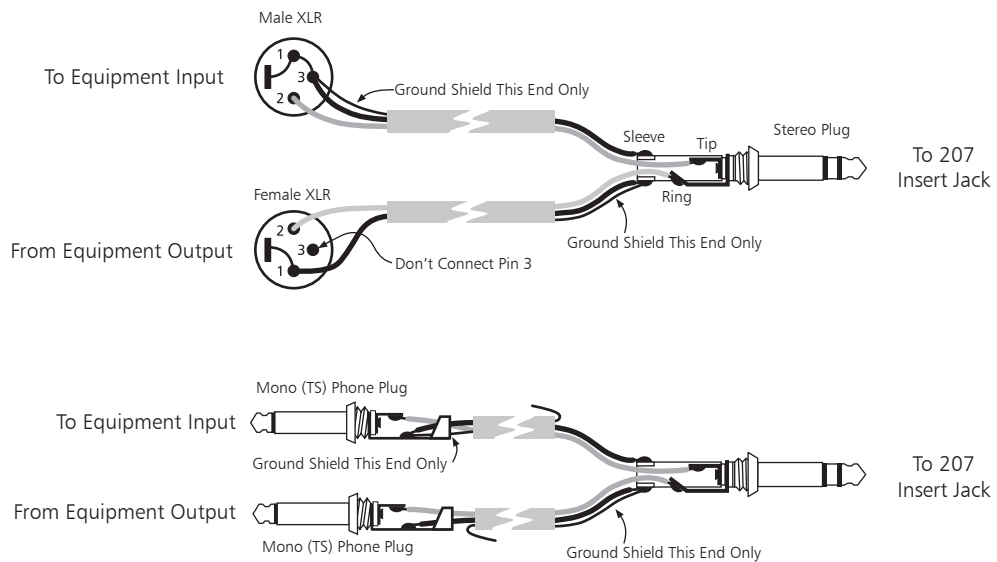

This product is protected under one or more of the following Aphex patents.

- 4,578,648
- 4,633,501
- 4,843,626
- 4,939,471
- 5,115,471
- 5,155,769
- 5,334,947
- 5,359,665
- 5,422,602
- 5,424,488
- 5,450,034
- 5,463,695
- 5,483,600
- 5,485,077
- 5,612,612
- 5,737,432
- 5,848,167
- 5,896,458
- 5,898,395
- 5,930,374
- 6,266,423

